

AOS-W Instant 8.4.0.x

Alcatel·Lucent 
Enterprise

User Guide

Copyright Information

Alcatel-Lucent and the Alcatel-Lucent Enterprise logo are trademarks of Alcatel-Lucent. To view other trademarks used by affiliated companies of ALE Holding, visit:

<https://www.al-enterprise.com/en/legal/trademarks-copyright>

All other trademarks are the property of their respective owners. The information presented is subject to change without notice. Neither ALE Holding nor any of its affiliates assumes any responsibility for inaccuracies contained herein. (2019)

Open Source Code

This product includes code licensed under the GNU General Public License, the GNU Lesser General Public License, and/or certain other open source licenses.

Revision History	11
About this Guide	12
Intended Audience	12
Related Documents	12
Conventions	12
Contacting Support	13
About AOS-W Instant	14
AOS-W Instant Overview	14
What is New in the Release	16
Setting up an OAW-IAP	21
Setting up AOS-W Instant Network	21
Provisioning an OAW-IAP	22
Logging in to the AOS-W Instant UI	24
Accessing the AOS-W Instant CLI	25
OAW-IAP Degraded State	27
Automatic Retrieval of Configuration	29
Managed Mode Operations	29
Prerequisites	29
Configuring Managed Mode Parameters	30
Verifying the Configuration	31
AOS-W Instant Old User Interface	32
Login Screen	32
Main Window	32
AOS-W Instant New User Interface	54
Introduction	54
Login Screen	54

Main Window	55
Initial Configuration Tasks	63
Configuring System Parameters	63
Configuring System Parameters	69
Changing Password	71
Customizing OAW-IAP Settings	73
Discovery Logic	73
Modifying the OAW-IAP Host Name	78
Configuring Zone Settings on an OAW-IAP	78
Specifying a Method for Obtaining IP Address	79
Configuring External Antenna	80
Configuring Radio Profiles for an OAW-IAP	82
Enabling Flexible Radio	85
Dual 5 GHz Radio Mode	85
Configuring Uplink VLAN for an OAW-IAP	86
Changing the OAW-IAP Installation Mode	87
Changing USB Port Status	88
Master Election and Virtual switch	88
Adding an OAW-IAP to the Network	90
Removing an OAW-IAP from the Network	91
Support for BLE Asset Tracking	91
ZF Openmatics Support for ZF BLE Tag Communication	92
IPM	93
Transmit Power Calculation Support on 200 Series and 300 Series Access Points	94
VLAN Configuration	95
VLAN Pooling	95
Uplink VLAN Monitoring and Detection on Upstream Devices	95
Multiple Management Interface	95
IPv6 Support	96

IPv6 Notation	96
Enabling IPv6 Support for OAW-IAP Configuration	96
Firewall Support for IPv6	98
GRE Backup Tunnel	98
Debugging Commands	99
Wireless Network Profiles	100
Configuring Wireless Network Profiles	100
Configuring Fast Roaming for Wireless Clients	124
Configuring Modulation Rates on a WLAN SSID	128
Multi-User-MIMO	129
Management Frame Protection	130
High Efficiency WLAN (HEW)	130
Disabling Short Preamble for Wireless Client	131
Disabling a WLAN SSID Profile	131
Editing a WLAN SSID Profile	132
Deleting a WLAN SSID Profile	132
Enhancements to WLAN SSID Configuration	132
Wired Profiles	134
Configuring a Wired Profile	134
Assigning a Profile to Ethernet Ports	142
Enabling 802.3az Energy Efficient Ethernet Standard	142
Editing a Wired Profile	143
Deleting a Wired Profile	143
LACP	144
Understanding Hierarchical Deployment	145
Loop Protection	146
Captive Portal for Guest Access	148
Understanding Captive Portal	148
Configuring a WLAN SSID for Guest Access	149

Configuring Wired Profile for Guest Access	158
IGMP	161
Configuring Internal Captive Portal for Guest Network	161
Configuring External Captive Portal for a Guest Network	166
Configuring Facebook Login	174
Configuring Guest Logon Role and Access Rules for Guest Users	177
Configuring Captive Portal Roles for an SSID	179
Configuring Walled Garden Access	183
Authentication and User Management	185
Managing OAW-IAP Users	185
Supported Authentication Methods	190
Supported EAP Authentication Frameworks	192
Configuring Authentication Servers	193
Understanding Encryption Types	212
Configuring Authentication Survivability	213
Configuring 802.1X Authentication for a Network Profile	216
Enhanced Open Authentication	218
WPA3	220
Enabling 802.1X Supplicant Support	223
Configuring MAC Authentication for a Network Profile	225
Configuring MAC Authentication with 802.1X Authentication	228
Configuring MAC Authentication with Captive Portal Authentication	230
Configuring WISPr Authentication	231
Blacklisting Clients	232
Uploading Certificates	235
Roles and Policies	239
Firewall Policies	239
Content Filtering	255
Configuring User Roles	260

Configuring Derivation Rules	264
Using Advanced Expressions in Role and VLAN Derivation Rules	272
DHCP Configuration	276
Configuring DHCP Scopes	276
Configuring the Default DHCP Scope for Client IP Assignment	290
Configuring Time-Based Services	292
Time Range Profiles	292
Configuring a Time Range Profile	293
Applying a Time Range Profile to a WLAN SSID	294
Verifying the Configuration	295
Applying a Time Range Profile to a Role	295
VPN Configuration	297
Understanding VPN Features	297
Configuring a Tunnel from an OAW-IAP to an OmniAccess Mobility Controller	299
Configuring Routing Profiles	305
Dynamic DNS Registration	307
Enabling Dynamic DNS	307
Configuring Dynamic DNS Updates for Clients	309
Verifying the Configuration	310
IAP-VPN Deployment	311
Understanding IAP-VPN Architecture	311
Configuring OAW-IAP and switch for IAP-VPN Operations	314
IAP-VPN Deployment Scenarios	322
Adaptive Radio Management	344
ARM Overview	344
Configuring ARM Features on an OAW-IAP	345
Configuring Radio Settings	354
DPI and Application Visibility	360
DPI	360

Enabling Application Visibility	360
Application Visibility	361
Enabling URL Visibility	361
Configuring ACL Rules for Application and Application Categories	362
Configuring Web Policy Enforcement Service	367
Voice and Video	370
WMM Traffic Management	370
Media Classification for Voice and Video Calls	373
Enabling Enhanced Voice Call Tracking	375
Wi-Fi Calling	375
Services	377
Configuring AirGroup	377
Configuring an OAW-IAP for RTLS Support	386
Support RTLS Tags with Aruba Central???	387
Configuring an OAW-IAP for ALE Support	388
Managing BLE Beacons	389
Clarity Live	391
Configuring OpenDNS Credentials	393
Integrating an OAW-IAP with Palo Alto Networks Firewall	393
Integrating an OAW-IAP with an XML API Interface	395
SES-imagotag ESL System	398
CALEA Integration and Lawful Intercept Compliance	399
BLE IoT for Data Communication	403
Cluster Security	407
Overview	407
Enabling Cluster Security	408
ZTP with Cluster Security	408
Low Assurance Devices	409
Cluster Security Debugging Logs	410

Verifying the Configuration	411
OAW-IAP Management and Monitoring	412
Managing an OAW-IAP from OmniVista 3600 Air Manager	412
WebSocket Connection	423
Uplink Configuration	424
Uplink Interfaces	424
Uplink Preferences and Switching	430
Intrusion Detection	436
Detecting and Classifying Rogue OAW-IAPs	436
OS Fingerprinting	436
Configuring WIP and Detection Levels	437
Configuring IDS	443
Mesh OAW-IAP Configuration	445
Mesh Network Overview	445
Setting up AOS-W Instant Mesh Network	446
Configuring Wired Bridging on Ethernet 0 for Mesh Point	447
Mesh Cluster Function	448
Mobility and Client Management	449
Layer-3 Mobility Overview	449
Configuring Layer-3 Mobility	450
Spectrum Monitor	452
Understanding Spectrum Data	452
Configuring Spectrum Monitors and Hybrid OAW-IAPs	459
OAW-IAP Maintenance	463
Backing up and Restoring OAW-IAP Configuration Data	463
Converting an OAW-IAP to a OAW-RAP and OAW-AP	465
Resetting a OAW-RAP or OAW-AP to an OAW-IAP	471
Rebooting the OAW-IAP	471
DRT Upgrade	472

Monitoring Devices and Logs	474
Configuring SNMP	474
Configuring a Syslog Server	478
Configuring TFTP Dump Server	480
Running Debug Commands	481
Uplink Bandwidth Monitoring	485
Hotspot Profiles	487
Understanding Hotspot Profiles	487
Configuring Hotspot Profiles	489
Sample Configuration	503
ClearPass Guest Setup	507
Configuring ClearPass Guest	507
Verifying ClearPass Guest Setup	510
Troubleshooting	511
Glossary of Terms	512

Revision History

The following table lists the revisions of this document.

Table 1: *Revision History*

Revision	Change Description
Revision 01	Initial release.

This User Guide describes the features supported by Alcatel-Lucent AOS-W Instant and provides detailed instructions for setting up and configuring the AOS-W Instant network.

Intended Audience

This guide is intended for administrators who configure and use OAW-IAPs.

Related Documents

In addition to this document, the OAW-IAP product documentation includes the following:

- Alcatel-Lucent AOS-W Instant Access Point Installation Guides
- Alcatel-Lucent AOS-W Instant CLI Reference Guide
- Alcatel-Lucent AOS-W Instant Quick Start Guide
- Alcatel-Lucent AOS-W Instant Release Notes

Conventions

The following conventions are used throughout this manual to emphasize important concepts:

Table 2: *Typographical Conventions*

Style Type	Description
<i>Italics</i>	This style is used to emphasize important terms and to mark the titles of books.
System items	This fixed-width font depicts the following: <ul style="list-style-type: none"> ■ Sample screen output ■ System prompts ■ Filenames, software devices, and specific commands when mentioned in the text.
Commands	In the command examples, this style depicts the keywords that must be typed exactly as shown.
<Arguments>	In the command examples, italicized text within angle brackets represents items that you should replace with information appropriate to your specific situation. For example: <pre># send <text message></pre> In this example, you would type “send” at the system prompt exactly as shown, followed by the text of the message you wish to send. Do not type the angle brackets.
[Optional]	Command examples enclosed in square brackets are optional. Do not type the square brackets.
{Item A Item B}	In the command examples, items within curly brackets and separated by a vertical bar represent the available choices. Enter only one choice. Do not type the curly brackets or bars.

The following informational icons are used throughout this guide:



Indicates helpful suggestions, pertinent information, and important things to remember.



Indicates a risk of damage to your hardware or loss of data.



Indicates a risk of personal injury or death.

Contacting Support

Table 3: *Contact Information*

Contact Center Online	
Main Site	https://www.al-enterprise.com
Support Site	https://businessportal2.alcatel-lucent.com
Email	ebg_global_supportcenter@al-enterprise.com
Service & Support Contact Center Telephone	
North America	1-800-995-2696
Latin America	1-877-919-9526
EMEA	+800 00200100 (Toll Free) or +1(650)385-2193
Asia Pacific	+65 6240 8484
Worldwide	1-818-878-4507

This chapter provides the following information:

- [AOS-W Instant Overview on page 14](#)
- [What is New in the Release on page 16](#)

AOS-W Instant Overview

AOS-W Instant virtualizes Alcatel-Lucent OmniAccess Mobility Controller capabilities on 802.11 capable access points creating a feature-rich enterprise-grade WLAN that combines affordability and configuration simplicity.

AOS-W Instant is a simple, easy to deploy turnkey WLAN solution consisting of one or more Instant Access Points. An Ethernet port with routable connectivity to the Internet or a self-enclosed network is used for deploying an Instant Wireless Network. An OAW-IAP can be installed at a single site or deployed across multiple geographically dispersed locations. Designed specifically for easy deployment and proactive management of networks, AOS-W Instant is ideal for small customers or remote locations without requiring any on-site IT administrator.

An OAW-IAP cluster consists of slave OAW-IAPs and a master OAW-IAP in the same VLAN, as they communicate with broadcast messages. A virtual switch is a combination of the whole cluster, as the slave OAW-IAPs and Master OAW-IAP coordinate to provide a controllerless AOS-W Instant solution. In an AOS-W Instant deployment scenario, the first OAW-IAP that comes up becomes the master OAW-IAP. All other OAW-IAPs joining the cluster after that OAW-IAP, become the slave OAW-IAPs.

In an AOS-W Instant deployment scenario, only the first OAW-IAP or the master OAW-IAP needs to be configured. The other OAW-IAPs download configurations from the first OAW-IAP that is configured. The AOS-W Instant solution constantly monitors the network to determine the OAW-IAP that must function as a master OAW-IAP at a given time. The master OAW-IAP may change as necessary from one OAW-IAP to another without impacting network performance.

Each OAW-IAP model has a minimum required software version. When a new OAW-IAP is added into an existing cluster, it can join the cluster only if the existing cluster is running at least the minimum required version of that OAW-IAP. If the existing cluster is running a version prior to the minimum required version of the new OAW-IAP, the new OAW-IAP will not come up and may reboot with the reason **Image sync fail**. To recover from this condition, upgrade the existing cluster to at least the minimum required version of the new OAW-IAP first, and add the new OAW-IAP. For more information about supported OAW-IAP platforms, refer to the *Alcatel-Lucent AOS-W Instant Release Notes*.



Alcatel-Lucent recommends that networks with more than 128 OAW-IAPs be designed as multiple, smaller virtual switch networks with Layer-3 mobility enabled between these networks.

Alcatel-Lucent OAW-IAPs are available in the following variants:

- US (United States)
- JP (Japan)
- IS (Israel)
- RoW

The following table provides the variants supported for each OAW-IAP platform:

Table 4: *Supported OAW-IAP Variants*

OAW-IAP Model (Reg Domain)	OAW-IAP###-US (US only)	OAW-IAP###-JP (Japan only)	OAW-IAP-###-IS (Israel only)	OAW-IAP-###-RoW (RoW except US/JP/IS)
OAW-AP-387	Yes	Yes	Yes	Yes
OAW-AP-514/OAW-AP-515	Yes	Yes	Yes	Yes
OAW-AP-303P	Yes	Yes	Yes	Yes
OAW-AP-344,/OAW-AP-345	Yes	Yes	Yes	Yes
OAW-AP203H	Yes	Yes	Yes	Yes
OAW-AP365/OAW-AP367	Yes	Yes	Yes	Yes
OAW-IAP334/OAW-AP335	Yes	Yes	Yes	Yes
OAW-IAP324/OAW-IAP325	Yes	Yes	Yes	Yes
OAW-IAP314/OAW-IAP315	Yes	Yes	Yes	Yes
OAW-AP303H	Yes	Yes	Yes	Yes
OAW-IAP277	Yes	Yes	No	Yes
OAW-IAP274/OAW-IAP275	Yes	Yes	Yes	Yes
OAW-IAP228	Yes	Yes	No	Yes
OAW-IAP224/OAW-IAP225	Yes	Yes	Yes	No
OAW-IAP214/OAW-IAP215	Yes	Yes	Yes	Yes
OAW-IAP207	Yes	Yes	Yes	Yes

Table 4: Supported OAW-IAP Variants

OAW-IAP Model (Reg Domain)	OAW-IAP###-US (US only)	OAW-IAP###-JP (Japan only)	OAW-IAP-###-IS (Israel only)	OAW-IAP-###-RoW (RoW except US/JP/IS)
OAW-IAP304/OAW-IAP305	Yes	Yes	Yes	Yes
OAW-AP203R/OAW-AP203RP	Yes	Yes	Yes	Yes
OAW-RAP155/OAW-RAP155P	Yes	Yes	Yes	No

For information on regulatory domains and the list of countries supported by the OAW-IAP-###-RW type, see the **Specifying Country Code** section in [Logging in to the AOS-W Instant UI on page 24](#).

AOS-W Instant WebUI

The AOS-W Instant WebUI provides a standard web-based interface that allows you to configure and monitor a Wi-Fi network. AOS-W Instant is accessible through a standard web browser from a remote management console or workstation and can be launched using the following browsers:

- Microsoft Internet Explorer 11 or earlier
- Apple Safari 6.0 or later
- Google Chrome 23.0.1271.95 or later
- Mozilla Firefox 17.0 or later

If the AOS-W Instant UI is launched through an unsupported browser, a warning message is displayed along with a list of recommended browsers. However, the users are allowed to log in using the **Continue login** link on the **Login** page.



To view the AOS-W Instant UI, ensure that JavaScript is enabled on the web browser.

The AOS-W Instant UI logs out automatically if the window is inactive for 15 minutes.

AOS-W Instant CLI

The AOS-W Instant CLI is a text-based interface that is accessible through an SSH session.

SSH access requires that you configure an IP address and a default gateway on the OAW-IAP and connect the OAW-IAP to your network. This is typically performed when the AOS-W Instant network on an OAW-IAP is set up.

What is New in the Release

This section lists the new features, enhancements, or hardware platforms introduced in Alcatel-Lucent AOS-W Instant 8.4.0.0.

New Features and Hardware Platforms

Table 5: *New Features in AOS-W Instant 8.4.0.0*

Feature	Description
Authentication Survivability Enhancement	OAW-IAPs are now able to cache user role for authentication survivability against remote link failures when working with ClearPass Policy Manager.
Automatic Mesh Role Assignment	Alcatel-Lucent AOS-W Instant supports enhanced role detection during OAW-IAP boot up and OAW-IAP running time. When a mesh point discovers that the Ethernet 0 port link is up, it sends loop detection packets to check whether the Ethernet 0 link is available. If it is available, the mesh point reboots and becomes a mesh portal. Otherwise, the mesh point does not reboot.
Auto Enable BLE Console Upon Errors	The dynamic console mode, when enabled is enhanced to perform special error checks and auto-enables BLE console if required.
Cellular Uplink Preemption	AOS-W Instant introduces a preemption enhancement method for IAP-VPN wherein OAW-IAPs can detect the reachability of a primary VPN over the Ethernet uplink by simultaneously keeping the secondary 3G/4G uplink stable.
ClearPass Policy Manager Certificate Validation for Downloadable User Roles (DUR)	The customized ClearPass Policy Manager certificates used for downloading user roles must be validated. The OAW-IAP retrieves the CA and uploads it to the flash memory for validation.
Client Match Support for Standalone Instant APs	AOS-W Instant supports the client match functionality across standalone OAW-IAPs within the same management VLAN. Client match uses the wired layer 2 protocol to synchronize information exchanged between OAW-IAPs.
Configuring Downloadable User Roles	User roles can now be downloaded from the ClearPass Policy Manager server if the role is not defined on the OAW-IAP. The role attributes can also be downloaded automatically.
Configuring Centralized DHCP Scopes	AOS-W Instant allows configuration of up to 32 VLAN IDs in a single DHCP profile on Centralized, L2 when split-tunnel is disabled.
Configuring GRE Backup Tunnel	AOS-W Instant allows you to configure a backup GRE tunnel to enable failover of the APs when the primary GRE tunnel goes down.
Configuring High Efficiency	IEEE 802.11ax, also known as High-Efficiency WLAN (HEW), is a multigigabit Wi-Fi technology that allows managed devices to communicate on both the 2.4 GHz and 5 GHz frequency bands.
Configuring Multiple PSK For WLAN SSID Profiles	AOS-W Instant now supports multiple PSK for WPA and WPA PSK-based deployments.
CloudGuest Scalability Enhancement	To reduce the load on the CloudGuest servers, OAW-IAP will send TCP keep-alives instead of Radius Status-Server messages as a means of heartbeat. For more information, refer to the <i>Aruba Instant 8.4.0.0 Release Notes</i> .
Default Values for ARM Settings Updated for AOS-W Instant	The default values for the ARM configuration settings have been updated to align with the default values in AOS-W.
Disable Activate Communication for Provisioning	AOS-W Instant now supports disabling Activate provisioning during the initial setup of an OAW-IAP.

Table 5: New Features in AOS-W Instant 8.4.0.0

Feature	Description
DRT Upgrade	AOS-W Instant supports DRT upgrade from OmniVista 3600 Air Manager over HTTPs and WebSocket. OAW-IAPs can report the DRT upgrade status to the OmniVista 3600 Air Manager server. OmniVista 3600 Air Manager displays the DRT upgrade status to users.
Enabling Cipher Algorithms	AOS-W Instant enables you to configure AES-CBC and AES-CTR based on your preference, to establish an SSH connection with the OAW-IAP.
Enabling DHCP Relay Agent Information Option (Option 82)	AOS-W Instant introduces the DHCP relay agent information option 82. This option allows the DHCP relay agent to insert circuit specific information into a request that is being forwarded to a DHCP server.
Enhancements to Time Range Profiles	AOS-W Instant introduces configuration of time range profiles that can be applied to SSIDs or roles to provide specific access during a specific time range.
Configuring Energy Efficient Ethernet.htm	AOS-W Instant now supports enabling 802.3az EEE on wired network profiles and then individually linking them to ethernet ports.
Enhancements to WLAN SSID Configuration	AOS-W Instant introduces support for configuration of up to 32 SSID profiles for cluster-based OAW-IAPs. When an SSID profile is created, an access rule with the same name is created. Ensure to keep extra access rules for role derivation. After creating 32 SSIDs, increase the capacity of the access rule profile to 64.
HTTP Proxy Support Through ZTP	Factory default OAW-IAPs can now communicate with the server through a HTTP proxy server DHCP which does not require authentication.
Loading Customized Certificates From Airwave	Customized certificates can now be uploaded to OmniVista 3600 Air Manager and then pushed from OmniVista 3600 Air Manager to the OAW-IAP.
Loop Protection	AOS-W Instant introduces the loop protection feature that detects and avoids the formation of loops on the Ethernet ports of an OAW-IAP. The loop protect feature can be enabled on all OAW-IAPs that have multiple Ethernet ports and it supports tunnel, split-tunnel, and bridge modes.
Mesh Cluster Functionality	AOS-W Instant introduces mesh cluster function for easy deployments of OAW-IAPs. Users can configure an ID and a password, and can provision OAW-IAPs to a specific mesh cluster.
Multicast DNS Server Cache Age Out Behavior	Some enhancements have been made to the multicast DNS age out behavior.
New IoT Endpoints and Payload options	<ul style="list-style-type: none"> ■ Two new IoT endpoints—Telemetry HTTPS and Telemetry WebSocket are introduced. ■ Five new payload message options—EnOcean Sensors, EnOcean switches, iBeacons, all BLE data, and eddystone beacon are introduced. ■ A new parameter is introduced in the CLI for RSSI reporting.
SES-imagotag ESL System	OAW-IAPs provide support for SES-imagotag's Electronic Shelf Label system. Electronic Shelf Label is used by various retailers to display the price of the products kept on retail shelves. SES-imagotag's Electronic Shelf Label system enables OAW-IAPs to configure ESL-Radio, ESL-Server, label, and client software.
Sharing Instant AP Name with Meridian	Administrators can identify OAW-IAPs in Meridian applications based on their names as it is easier to associate an OAW-IAP's name with its location.

Table 5: New Features in AOS-W Instant 8.4.0.0

Feature	Description
Support for Channels 169 and 173 on Outdoor Instant AP	The 5 GHz band for outdoor OAW-IAPs support the 169 and 173 channels. These channels are currently supported only in India.
Support for Extended ASCII Characters	AOS-W Instant now supports extended ASCII characters.
Support for Multiple Active VPN Tunnels on Instant	Starting from AOS-W Instant 8.4.0.0, you can configure multiple active VPN tunnels on Centralized, L2 DHCP scopes.
Support for WPA3	AOS-W Instant now supports WPA3 certified features to enhance Wi-Fi security.
Support for Wi-Fi Calling	AOS-W Instant now supports Wi-Fi calling identification, prioritization, and reporting.
Third Party Asset Tracking Integration	AOS-W Instant enables the integration of built-in IoT BLE messages with third party servers. This integration provides a flexible interface for users to build their own endpoint and service without meridian support. switches send messages received from OAW-IAPs to endpoints.
User VLAN Derivation	AOS-W Instant supports derivation of VLANs from three Microsoft tunnel attributes. However, all the three attributes must be present at the same time.
WebUI Enhancement	AOS-W Instant introduces the new WebUI. The key features of the new WebUI are that it has a modern look and feel with a responsive layout that is mobile and tablet friendly and it has an improvised search capability.
Wildcard ACL Support on Instant	AOS-W Instant now supports wildcard ACL to enable ARP requests or responses to match with the ARP flow. The wildcard flow is used to either allow, deny, or send packet count to the OpenFlow switch.
Zeroization of TPM Keys	AOS-W Instant introduces zeroization of TPM keys in FIPS-based OAW-IAPs under circumstances that present a threat to their integrity such as unauthorized removal of FIPS-based OAW-IAPs, evidence of tampering, and so on.
ZTP Support for Instant AP Conversion	AOS-W Instant introduces ZTP support for automatic conversion of OAW-IAPs to OAW-APs or OAW-RAPs.
ZTP with Cluster Security	AOS-W Instant now supports ZTP with DTLS enabled cluster security.

Table 6: *New Hardware Platforms in AOS-W Instant 8.4.0.0*

Hardware	Description
OAW-AP-303P Access Point	<p>The Alcatel-Lucent OAW-AP-303P access point is a high-performance dual-radio wireless device that supports IEEE802.11ac Wave 2 standard. The OAW-IAP uses MU-MIMO technology to provide secure wireless connectivity for both 2.4 GHz 802.11 b, 802.11g, 802.11n, and 802.11ac and 5 GHz 802.11 a, 802.11n, and 802.11ac Wi-Fi networks.</p> <p>The OAW-IAP provides the following capabilities:</p> <ul style="list-style-type: none"> ■ IEEE 802.11 a, 802.11b, 802.11g, 802.11n, and 802.11ac operation as a wireless access point ■ IEEE 802.11a, 802.11b, 802.11g, 802.11n, and 802.11ac operation as a wireless AM ■ IEEE 802.11a, 802.11b, 802.11g, 802.11n, and 802.11ac spectrum monitor ■ Compatibility with IEEE 802.3af, 802.11at, and 802.11bt PoE ■ Supports PoE (E1 port) with PSE power ■ Integrated BLE or Zigbee radio <p>For complete technical details and installation instructions, see the <i>Alcatel-Lucent OAW-AP-303P Access Points Installation Guide</i>.</p>
OAW-AP-387 Access Point	<p>The OAW-AP-387 access point is a high-performance dual-radio wireless device that leverages 802.11ac Wave 2 and 802.11 ad standards as a unique point-to-point solution. The OAW-IAP provides secure wireless bringing connectivity. The 5 GHz radio supports 802.11g, 802.11n, and 802.11ac Wi-Fi networks. The 60 GHz radio supports 802.11ad Wi-Fi networks.</p> <p>The OAW-IAP provides the following capabilities:</p> <ul style="list-style-type: none"> ■ IEEE 802.11 a, 802.11b, 802.11g, 802.11n, 802.11ac, and 802.11ad operation as a wireless bridge. ■ Compatibility with IEEE 802.3at PoE power sources and slightly reduced function with IEEE 802.3af PoE power sources. ■ Integrated BLE radio. <p>For complete technical details and installation instructions, see <i>Alcatel-Lucent OAW-AP-387 Access Points Installation Guide</i>.</p>
OAW-AP-514 and OAW-AP-515 Access Points	<p>The Alcatel-Lucent OAW-510 Series access points (OAW-AP-514 and OAW-AP-515) are high-performance, multi-radio wireless devices that can be deployed in either switch-based (AOS-W) or switch less (Alcatel-Lucent AOS-W Instant) network environments. These APs deliver high performance concurrent 2.4 GHz and 5 GHz 802.11ax Wi-Fi functionality with MIMO radios (2x2 in 2.4 GHz, 4x4 in 5 GHz), while also supporting legacy 802.11a, 802.11b, 802.11g, 802.11n, 802.11ac wireless services. For complete technical details and installation instructions, see <i>Alcatel-Lucent OAW-510 Series Access Points Installation Guide</i>.</p>

This chapter describes the following procedures:

- [Setting up AOS-W Instant Network on page 21](#)
- [Provisioning an OAW-IAP on page 22](#)
- [Logging in to the AOS-W Instant UI on page 24](#)
- [Accessing the AOS-W Instant CLI on page 25](#)
- [OAW-IAP Degraded State on page 27](#)

Setting up AOS-W Instant Network

Before installing an OAW-IAP:

- Ensure that you have an Ethernet cable of the required length to connect an OAW-IAP to the home router.
- Ensure that you have one of the following power sources:
 - IEEE 802.3af/at-compliant PoE source. The PoE source can be any power source equipment switch or a midspan power source equipment device.
 - OAW-IAP power adapter kit.

To set up the AOS-W Instant network, perform the following procedures :

1. [Connecting an OAW-IAP on page 21](#)
2. [Assigning an IP address to the OAW-IAP on page 21](#)

Connecting an OAW-IAP

Based on the type of the power source used, perform one of the following steps to connect an OAW-IAP to the power source:

- PoE switch—Connect the Ethernet 0 port of the OAW-IAP to the appropriate port on the PoE switch.
- PoE midspan—Connect the Ethernet 0 port of the OAW-IAP to the appropriate port on the PoE midspan.
- AC to DC power adapter—Connect the 12V DC power jack socket to the AC to DC power adapter.



OAW-RAP155P supports PSE for 802.3at-powered device (class 0-4) on one port (Ethernet 1 or Ethernet 2), or 802.3af-powered DC IN (Power Socket) on two ports (Ethernet 1 and Ethernet 2).

Assigning an IP address to the OAW-IAP

The OAW-IAP needs an IP address for network connectivity. When you connect an OAW-IAP to a network, it receives an IP address from a DHCP server.

To obtain an IP address for an OAW-IAP:

1. Ensure that the DHCP service is enabled on the network.
2. Connect the Ethernet 0 port of OAW-IAP to a switch or router using an Ethernet cable.
3. Connect the OAW-IAP to a power source. The OAW-IAP receives an IP address provided by the switch or router.



If there is no DHCP service on the network, the OAW-IAP can be assigned a static IP address. If a static IP is not assigned, the OAW-IAP obtains an IP automatically within the 169.254 subnet.

Assigning a Static IP

To assign a static IP to an OAW-IAP:

1. Connect a terminal, PC, or workstation running a terminal emulation program to the **Console** port on the OAW-IAP.
2. Turn on the OAW-IAP. An autoboot countdown prompt that allows you to interrupt the normal startup process and access **apboot** is displayed.
3. Press **Enter** key before the timer expires. The OAW-IAP goes into the **apboot** mode.
4. In the **apboot** mode, execute the following commands to assign a static IP to the OAW-IAP.

```
Hit <Enter> to stop autoboot: 0
apboot>
apboot> setenv ipaddr 192.0.2.0
apboot> setenv netmask 255.255.255.0
apboot> setenv gatewayip 192.0.2.2
apboot> save
Saving Environment to Flash...
Un-Protected 1 sectors
.done
Erased 1 sectors
Writing
```

5. Use the **printenv** command to view the configuration.

```
apboot> printenv
```

Provisioning an OAW-IAP

This section provides the following information:

- [ZTP and NTP Server and Synchronization](#)
- [Provisioning OAW-IAPs through OmniVista 3600 Air Manager](#)

ZTP of OAW-IAPs

ZTP eliminates the traditional method of deploying and maintaining devices and allows you to provision new devices in your network automatically, without manual intervention. Following are the ZTP methods for AOS-W Instant.

NTP Server and OAW-IAP Synchronization

In order for ZTP to be successful, the timezone of the OAW-IAP must be in synchronization with the NTP server.



To facilitate ZTP using the AMP, or Activate, you must configure the firewall and wired infrastructure to either allow the NTP traffic to pool.ntp.org, or provide alternative NTP servers under DHCP options. For more information on configuring an NTP server, see [NTP Server](#).

In a scenario where the NTP server is unreachable, the connection between the OAW-IAP and Activate will fall back to the unsecured status. The NTP client process running in the back end will continuously attempt to reconnect to the NTP server until a secure connection is established. The NTP client process receives a response from the NTP server on successfully establishing a connection and notifies the CLI process which runs a series of checks to ensure the NTP server is reachable.

Connecting to a Provisioning Wi-Fi Network

The OAW-IAPs boot with factory default configuration and try to provision automatically. If the automatic provisioning is successful, the AOS-W Instant SSID will not be available. If OmniVista 3600 Air Manager and

Activate are not reachable and the automatic provisioning fails, the AOS-W Instant SSID becomes available and the users can connect to a provisioning network by using the AOS-W Instant SSID.

To connect to a provisioning Wi-Fi network:

1. Ensure that the client is not connected to any wired network.
2. Connect a wireless-enabled client to a provisioning Wi-Fi network: for example, AOS-W Instant.
3. If the Windows operating system is used:
 - a. Click the wireless network connection icon in the system tray. The **Wireless Network Connection** window is displayed.
 - b. Click the AOS-W Instant network and then click **Connect**.
4. If the Mac operating system is used:
 - a. Click the **AirPort** icon. A list of available Wi-Fi networks is displayed.
 - b. Click the **instant** network.



The AOS-W Instant SSIDs are broadcast in 2.4 GHz only.

The provisioning SSID for all APs running AOS-W Instant 6.5.2.0 onwards, including legacy OAW-IAPs is **SetMeUp-xx:xx:xx**.

OAW-IAP Cluster

OAW-IAPs in the same VLAN automatically find each other and form a single functioning network managed by a virtual switch.



Moving an OAW-IAP from one cluster to another requires a factory reset of the OAW-IAP.

Disabling the Provisioning Wi-Fi Network

The provisioning network is enabled by default. AOS-W Instant provides the option to disable the provisioning network through the console port. Use this option only when you do not want the default SSID AOS-W Instant to be broadcast in your network.

To disable the provisioning network:

1. Connect a terminal, PC, or workstation running a terminal emulation program to the **Console** port on the OAW-IAP.
2. Configure the terminal or terminal emulation program to use the following communication settings:

Table 7: Terminal Communication Settings

Baud Rate	Data Bits	Parity	Stop Bits	Flow Control
9600	8	None	1	None

3. Turn on the OAW-IAP. An autoboot countdown prompt that allows you to interrupt the normal startup process and access apboot is displayed.
4. Click **Enter** key before the timer expires. The OAW-IAP goes into the apboot mode through console.
5. In the apboot mode, execute the following commands to disable the provisioning network:

```
apboot> factory_reset
apboot> setenv disable_prov_ssid 1
apboot> saveenv
apboot> reset
```

Disabling Activate Communication with OAW-IAP for Provisioning

Some customers do not use Activate either because of their security policy or because it is a new site and they do not have internet connectivity when the OAW-IAP is initially brought up. These customers prefer to disable all communications between the OAW-IAP and Activate during initial provisioning.

Under these circumstances, Alcatel-Lucent AOS-W Instant provides 3 methods to disable Activate provisioning. You may choose either of the following methods to disable Activate provisioning during the initial setup:

- Use the configuration command to disable provisioning by Activate using the AOS-W Instant CLI.

```
(Instant AP) (config)# activate-disable
```
- Configure a DHCP profile with a DHCP option <type> **43** and the <value> **activate-disable=True**. The DHCP option 43 will broadcast the provisioning information to the OAW-IAP from the DHCP server instead of Activate.

```
(Instant AP) (config)# ip dhcp <profile-name>  
(Instant AP) (DHCP profile <profile-name>)# option 43 activate-disable=True
```
- Configure a DHCP profile with a DHCP option <type> **60** and the <value> **ArubaInstantAP**.

```
(Instant AP) (config)# ip dhcp <profile-name>  
(Instant AP) (DHCP profile <profile-name>)# option 60 ArubaInstantAP
```

Provisioning OAW-IAPs through OmniVista 3600 Air Manager

OmniVista 3600 Air Manager is a powerful platform and easy-to-use network operations system that manages Alcatel-Lucent wireless, wired, and remote access networks, as well as wired and wireless infrastructures from a wide range of third-party manufacturers. With its easy-to-use interface, OmniVista 3600 Air Manager provides real-time monitoring, proactive alerts, historical reporting, as well as fast and efficient troubleshooting. It also offers tools that manage RF coverage, strengthen wireless security, and demonstrate regulatory compliance.

For information on provisioning OAW-IAPs through OmniVista 3600 Air Manager, refer to the *OmniVista 3600 Air Manager Deployment Guide*.

Logging in to the AOS-W Instant UI

Launch a web browser and enter <http://instant.Alcatel-Lucentnetworks.com>. In the login screen, enter the following credentials:

- Username—admin
- Password—admin

When you use a provisioning Wi-Fi network to connect to the Internet, all browser requests are directed to the AOS-W Instant UI. For example, if you enter www.example.com in the address bar, you are directed to the AOS-W Instant UI. You can change the default login credentials after the first login.

If an OAW-IAP does not obtain an IP address, it assigns itself 169.x.x.x as the IP address. In this case, DNS requests from clients on a provisioning SSID will not receive a response because of lack of network connectivity. Hence, automatic redirection to the AOS-W Instant UI instant.arubanetworks.com will fail. In such a case, you must manually open instant.arubanetworks.com on your browser to access the AOS-W Instant WebUI.



Regulatory Domains

The IEEE 802.11, 802.11b, 802.11g, or 802.11n Wi-Fi networks operate in the 2.4 GHz spectrum and IEEE 802.11a or 802.11n operate in the 5 GHz spectrum. The spectrum is divided into channels. The 2.4 GHz spectrum is divided into 14 overlapping, staggered 20 MHz wireless carrier channels. These channels are spaced 5 MHz apart. The 5 GHz spectrum is divided into more channels. The channels that can be used in a particular country vary based on the regulations of that country.

The initial Wi-Fi setup requires you to specify the country code for the country in which the OAW-IAP operates. This configuration sets the regulatory domain for the radio frequencies that the OAW-IAPs use. Within the regulated transmission spectrum, a HT 802.11ac, 802.11a, 802.11b, 802.11g, or 802.11n radio setting can be configured. The available 20 MHz, 40 MHz, or 80 MHz channels are dependent on the specified country code.

You cannot change a country code for OAW-IAPs in regulatory domains such as Japan and Israel. However, for OAW-IAP-US and OAW-IAP-RW variants, you can select from the list of supported regulatory domains. If the supported country code is not in the list, contact your Alcatel-Lucent Support team to know if the required country code is supported and obtain the software that supports the required country code.



Improper country code assignments can disrupt wireless transmissions. Most countries impose penalties and sanctions on operators of wireless networks with devices set to improper country codes.

To view the country code information, run the **show country-codes** command.

Specifying Country Code

The **Country Code** window is displayed for the OAW-IAP-US and OAW-IAP-RW variants when you login to the OAW-IAP UI for the first time. The **Please Specify the Country Code** drop-down list displays only the supported country codes. If the OAW-IAP cluster consists of multiple OAW-IAP platforms, the country codes supported by the master OAW-IAP is displayed for all other OAW-IAPs in the cluster. Select a country code from the list and click **OK**. The OAW-IAP operates in the selected country code domain.



Country code once set, cannot be changed in the AOS-W Instant UI. It can be changed only by using the **virtual-controller-country** command in the AOS-W Instant CLI.

Slave OAW-IAPs obtain country code configuration settings from the master OAW-IAP.

You can also view the list of supported country codes for the OAW-IAP-US and OAW-IAP-RW variants by using the **show country-codes** command.

Accessing the AOS-W Instant CLI

AOS-W Instant supports the use of CLI for scripting purposes. When you make configuration changes on a master OAW-IAP in the CLI, all associated OAW-IAPs in the cluster inherit these changes and subsequently update their configurations. By default, you can access the CLI from the serial port or from an SSH session. You must explicitly enable Telnet access on the OAW-IAP to access the CLI through a Telnet session.

For information on enabling SSH and Telnet access to the OAW-IAP CLI, see [Terminal access on page 67](#).

Connecting to a CLI Session

On connecting to a CLI session, the system displays its host name followed by the login prompt. Use the administrator credentials to start a CLI session. For example:

```
User: admin
```

If the login is successful, the privileged command mode is enabled and a command prompt is displayed. For example:

```
(Instant AP)#
```

The privileged EXEC mode provides access to **show**, **clear**, **ping**, **traceroute**, and **commit** commands. The configuration commands are available in the config mode. To move from Privileged EXEC mode to the Configuration mode, enter the following command at the command prompt:

```
(Instant AP)# configure terminal
```

The configure terminal command allows you to enter the basic configuration mode and the command prompt is displayed as follows:

```
(Instant AP) (config) #
```

The AOS-W Instant CLI allows CLI scripting in several other subcommand modes to allow the users to configure individual interfaces, SSIDs, access rules, and security settings.

You can use the question mark (?) to view the commands available in a privileged EXEC mode, configuration mode, or subcommand mode.



Although automatic completion is supported for some commands such as **configure terminal**, the complete **exit** and **end** commands must be entered at command prompt.

Applying Configuration Changes

Each command processed by the virtual switch is applied on all the slaves in a cluster. The changes configured in a CLI session are saved in the CLI context. The CLI does not support the configuration data exceeding the 4K buffer size in a CLI session. Therefore, it is recommended that you configure fewer changes at a time and apply the changes at regular intervals.

To apply and save the configuration changes at regular intervals, execute the following command in the privileged EXEC mode:

```
(Instant AP) # commit apply
```

To apply the configuration changes to the cluster without saving the configuration, execute the following command in the privileged EXEC mode:

```
(Instant AP) # commit apply no-save
```

To view the changes that are yet to be applied, execute the following command in the privileged EXEC mode:

```
(Instant AP) # show uncommitted-config
```

To revert to the earlier configuration, execute the following command in the privileged EXEC mode.

```
(Instant AP) # commit revert
```

Example:

To apply and view the configuration changes:

```
(Instant AP) (config) # rf dot11a-radio-profile
```

```
(Instant AP) # show uncommitted-config
```

Using Sequence-Sensitive Commands

The AOS-W Instant CLI does not support positioning or precedence of sequence-sensitive commands. Therefore, it is recommended that you remove the existing configuration before adding or modifying the configuration details for sequence-sensitive commands. You can either delete an existing profile or remove a specific configuration by using the **no** commands.

The following table lists the sequence-sensitive commands and the corresponding **no** commands to remove the configuration:

Table 8: *Sequence-Sensitive Commands*

Sequence-Sensitive Command	Corresponding no command
opendns <username <password>	no opendns

Table 8: Sequence-Sensitive Commands

Sequence-Sensitive Command	Corresponding no command
<code>rule <dest> <mask> <match> <protocol> <start-port> <end-port> {permit deny src-nat dst-nat {<IP-address> <port> <port>}} [<option1...option9>]</code>	<code>no rule <dest> <mask> <match> <protocol> <start-port> <end-port> {permit deny src-nat dst-nat}</code>
<code>mgmt-auth-server <auth-profile-name></code>	<code>no mgmt-auth-server <auth-profile-name></code>
<code>set-role <attribute>{{equals not-equals starts-with ends-with contains} <operator> <role> value-of}</code>	<code>no set-role <attribute>{{equals not-equals starts-with ends-with contains} <operator> value-of}</code> <code>no set-role</code>
<code>set-vlan <attribute>{{equals not-equals starts-with ends-with contains} <operator> <VLAN-ID> value-of}</code>	<code>no set-vlan <attribute>{{equals not-equals starts-with ends-with contains} <operator> value-of}</code> <code>no set-vlan</code>
<code>auth-server <name></code>	<code>no auth-server <name></code>

Banner and Loginsession Configuration

Starting from AOS-W Instant 6.5.0.0-4.3.0.0, the Banner and Loginsession Configuration feature is introduced in the OAW-IAP. The text banner can be displayed at the login prompt when users are on a management (Telnet or SSH) session of the CLI, and the management session can remain active even when there is no user activity involved.

The **banner** command defines a text banner to be displayed at the login prompt of a CLI. AOS-W Instant supports up to 16 lines text, and each line accepts a maximum of 255 characters including spaces.

To configure a banner:

```
(Instant AP) (config)# banner motd <motd_text>
```

To display the banner:

```
(Instant AP)# show banner
```

The **loginsession** command configures the management session (Telnet or SSH) to remain active without any user activity.

To define a timeout interval:

```
(Instant AP) (config) #loginsession timeout <val>
```

<val> can be any number of minutes from 5 to 60, or any number of seconds from 1 to 3600. You can also specify a timeout value of 0 to disable CLI session timeouts. The users must re-login to the OAW-IAP after the session times out. The session does not time out when the value is set to 0.

OAW-IAP Degraded State

The following conditions may cause an OAW-IAP to prevent users from logging in to the WebUI and CLI. In most cases, the OAW-IAP will display the error message **Warning: CLI Module is running in a degraded state. Some commands will not function**

1. When the OAW-IAP cannot be a master OAW-IAP because it has no IP address, and does not have an uplink connection.
2. When the OAW-IAP is unable to join the cluster because of a missing country code, image, or incorrect regulatory hardware.

3. When the OAW-IAP has been denied permission to the existing cluster based on the allowed AP whitelist or the auto-join configuration present in the cluster.
4. In a mixed class network, when the slave OAW-IAPs join the master OAW-IAP with a different software version, causing the image sync from OmniVista 3600 Air Manager to fail.

Additionally, the following console messages indicate other error conditions:

- **4-0 Authentication server failure:** Incorrect username or password.
- **5-0 Authentication server timeout** - no response from RADIUS server.
- **7-0:** Indicates PAPI errors within the OAW-IAP. The OAW-IAP log messages provide details on the error condition. Consult Alcatel-Lucent Technical Support for further assistance.
- **8-0:** Indicates an authentication failure or an incomplete synchronization of a swarm configuration.

An example of one of the above mentioned console messages is **Internal error 7-0, please contact support**.

This chapter provides the following information:

- [Managed Mode Operations on page 29](#)
- [Prerequisites on page 29](#)
- [Configuring Managed Mode Parameters on page 30](#)
- [Verifying the Configuration on page 31](#)

Managed Mode Operations

OAW-IAPs support managed mode operations to retrieve the configuration file from a server through the FTP or FTPS, and automatically update the OAW-IAP configuration.

The server details for retrieving configuration files are stored in the basic configuration of the OAW-IAPs. The basic configuration of an OAW-IAP includes settings specific to an OAW-IAP, for example, host name, static IP, and radio configuration settings. When an OAW-IAP boots up, it performs a GET operation to retrieve the configuration (.cfg) file from the associated server using the specified download method.

After the initial configuration is applied to the OAW-IAPs, the configuration can be changed at any point. You can configure a polling mechanism to fetch the latest configuration by using an FTP or FTPS client periodically. If the remote configuration is different from the one running on the OAW-IAP and if a difference in the configuration file is detected by the OAW-IAP, the new configuration is applied. At any given time, OAW-IAPs can fetch only one configuration file, which may include the configuration details specific to an OAW-IAP. For configuring polling mechanism and downloading configuration files, the users are required to provide credentials (username and password). However, if automatic mode is enabled, the user credentials required to fetch the configuration file are automatically generated. To enable automatic configuration of the OAW-IAPs, configure the managed mode command parameters.

Prerequisites

Perform the following checks before configuring the managed mode command parameters:

- Ensure that the OAW-IAP is running AOS-W Instant 6.2.1.0-3.4 or later versions.
- When the OAW-IAPs are in the managed mode, ensure that the OAW-IAPs are not managed by OmniVista 3600 Air Manager.

Configuring Managed Mode Parameters

To enable the automatic configuration, perform the steps described in the following table:

Table 9: *Managed Mode Commands*

Steps	Command
1. Start a CLI session to configure the managed-mode profile for automatic configuration.	<code>(Instant AP) (config)# managed-mode-profile</code>
2. Enable automatic configuration Or Specify the user credentials.	<code>(Instant AP) (managed-mode-profile)# automatic</code> Or <code>(Instant AP) (managed-mode-profile)# username <username></code> <code>(Instant AP) (managed-mode-profile)# password <password></code> NOTE: If the automatic mode is enabled, the user credentials are automatically generated based on OAW-IAP MAC address.
3. Specify the configuration file.	<code>(Instant AP) (managed-mode-profile)# config-filename <file_name></code> Filename—Indicates filename in the alphanumeric format. Ensure that configuration file name does not exceed 40 characters.
4. Specify the configuration file download method.	<code>(Instant AP) (managed-mode-profile)# download-method <ftp ftps></code> You can use either FTP or FTPS for downloading configuration files.
5. Specify the name of the server or the IP address of the server from which the configuration file must be downloaded.	<code>(Instant AP) (managed-mode-profile)# server <server_name></code>
6. Configure the day and time at which	<code>(Instant AP) (managed-mode-profile)# sync-time day <dd> hour <hh> min <mm> window <window></code> Based on the expected frequency of configuration changes and maintenance window, you can set the configuration synchronization timeline. <ul style="list-style-type: none"> ■ <code>day <dd></code>—Indicates day, for example to configure Sunday as the day, specify 01. To

Table 9: Managed Mode Commands

Steps	Command
the OAW-IAPs can poll the configuration on files from the server.	configure the synchronization period as everyday, specify 00. <ul style="list-style-type: none"> ■ <code>hour <hh></code>—Indicates hour within the range of 0–23. ■ <code>min <mm></code>—Indicates minutes within the range of 0–59. ■ <code>window <hh></code>—Defines a window for synchronization of the configuration file. The default value is 3 hours.
7. Configure the time interval in minutes between two retries, after which OAW-IAPs can retry downloading the configuration file.	<pre>(Instant AP) (managed-mode-profile) # retry-poll-period <seconds></pre> <p>NOTE: Specify the retry interval in seconds within the range of 5–60 seconds. The default retry interval is 5 seconds.</p>
8. Apply the configuration changes.	<pre>(Instant AP) (managed-mode-profile) # end (Instant AP) # commit apply</pre>

If you want to apply the configuration immediately and do not want to wait until next configuration retrieval attempt, execute the following command:

```
(Instant AP) # managed-mode-sync-server
```

Example

To configure managed mode profile:

```
(Instant AP) (config) # managed-mode-profile
```

Verifying the Configuration

To verify if the automatic configuration functions, perform the following checks:

1. Verify the status of configuration by running the following commands at the command prompt:

```
(Instant AP) # show managed-mode config
(Instant AP) # show managed-mode status
```

2. Verify the status of download by running the following command at the command prompt:

```
(Instant AP) # show managed-mode logs
```

If the configuration settings retrieved in the configuration file are incomplete, OAW-IAPs reboot with the earlier configuration.

This chapter describes the following WebUI elements:

- [Login Screen on page 32](#)
- [Main Window on page 32](#)

Login Screen

The AOS-W Instant login page allows you to perform the following tasks:

- View AOS-W Instant Network Connectivity summary
- View the WebUI in a specific language
- Log in to the WebUI

Viewing Connectivity Summary

The login page also displays the connectivity status to the AOS-W Instant network. The users can view a summary that indicates the status of the Internet availability, uplink, cellular modem and signal strength, VPN, and OmniVista 3600 Air Manager configuration details before logging in to the WebUI.

Language

The **Language** drop-down list contains the available languages and allows users to select their preferred language before logging in to the WebUI. A default language is selected based on the language preferences in the client desktop operating system or browser. If AOS-W Instant cannot detect the language, then **English** is used as the default language.

You can also select the required language option from the **Languages** drop-down list located on the AOS-W Instant main window.

Logging into the WebUI

To log in to the WebUI, enter the following credentials:

- Username—admin
- Password—admin

The WebUI main window is displayed.

Main Window

After you log in to AOS-W Instant, the WebUI main window is displayed.

Figure 1 AOS-W Instant Main Window

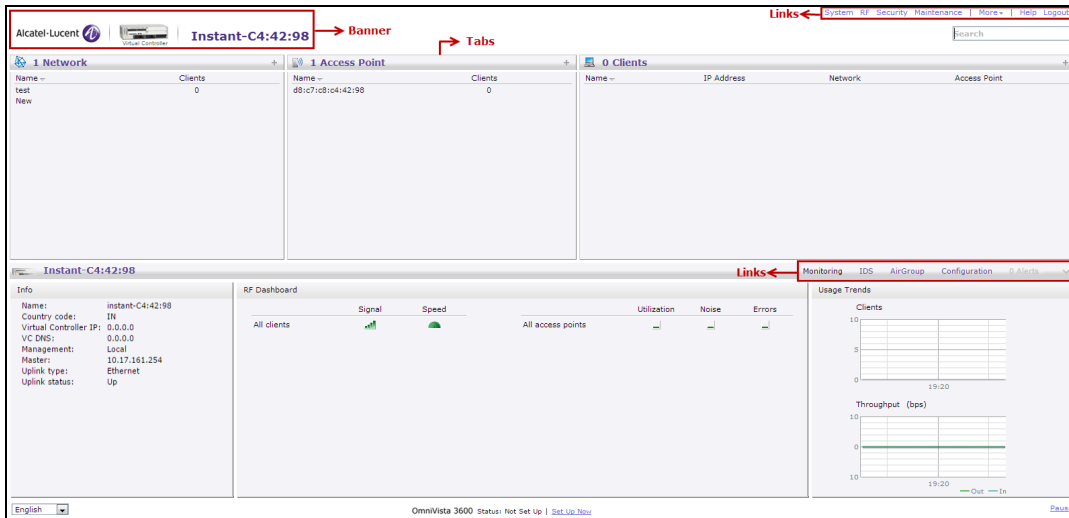

The main window consists of the following elements:

- [Banner](#)
- [Search Text Box](#)
- [Tabs](#)
- [Links](#)
- [Views](#)

Banner

The banner is a horizontal rectangle that appears on the AOS-W Instant main window. It displays the company name, logo, and the virtual switch name.

Search Text Box

Administrators can search for an OAW-IAP, client, or a network in the **Search** text box. When you type a search text, the search function suggests matching keywords and allows you to automatically complete the search text entry.

Tabs

The AOS-W Instant main window consists of the following tabs:

- [Network Tab](#)—Provides information about the network profiles configured in the Instant network.
- [Access Points Tab](#)—Provides information about the OAW-IAPs configured in the Instant network.
- [Clients Tab](#)—Provides information about the clients in the Instant network.

Each tab appears in a compressed view by default. The number of networks, OAW-IAPs, or clients in the network precedes the corresponding tab names. The individual tabs can be expanded or collapsed by clicking the tabs. The list items in each tab can be sorted by clicking the triangle icon next to the heading labels.

Network Tab

This tab displays a list of Wi-Fi networks that are configured in the Instant network. The network names are displayed as links. The expanded view displays the following information about each WLAN SSID:

- **Name**—Name of the network.
- **Clients**—Number of clients that are connected to the network.

- **Type**—Type of network such as Employee, Guest, or Voice.
- **Band**—Band in which the network is broadcast: 2.4 GHz band, 5 GHz band, or both.
- **Authentication Method**—Authentication method required to connect to the network.
- **Key Management**—Authentication key type.
- **IP Assignment**—Source of IP address for the client.
- **Zone**—OAW-IAP zone configured on the SSID.

To add a wireless network profile, click the **New** link on the **Network** tab. To edit, click the **edit** link that is displayed on clicking the network name in the **Network** tab. To delete a network, click the **x** link.

For more information on the procedure to add or modify a wireless network, see [Wireless Network Profiles on page 100](#).

Access Points Tab

If the Auto-Join Mode feature is enabled, a list of enabled and active OAW-IAPs in the AOS-W Instant network is displayed on the **Access Points** tab. The OAW-IAP names are displayed as links. If the Auto Join Mode feature is disabled, the **New** link is displayed. Click this link to add a new OAW-IAP to the network. If an OAW-IAP is configured and not active, its MAC Address is displayed in red.

The expanded view of the **Access Points** tab displays the following information about each OAW-IAP:

- **Name**—Name of the OAW-IAP. If the OAW-IAP functions as a master OAW-IAP in the network, the asterisk sign "*" is displayed next to the OAW-IAP.
- **IP Address**—IP address of the OAW-IAP.
- **Mode**—Mode of the OAW-IAP.
 - **Access**—In this mode, the OAW-IAP serves clients and scans the home channel for spectrum analysis while monitoring channels for rogue OAW-IAPs in the background.
 - **Monitor**—In this mode, the OAW-IAP acts as a dedicated AM, scanning all channels for rogue OAW-IAPs and clients.
- **Spectrum**—When enabled, the OAW-IAP functions as a dedicated full-spectrum RF monitor, scanning all channels to detect interference from neighboring OAW-IAPs or non-Wi-Fi devices such as microwaves and cordless phones. When Spectrum is enabled, the OAW-IAP does not provide access services to clients.
- **Clients**—Number of clients that are currently associated to the OAW-IAP.
- **Type**—Model number of the OAW-IAP.
- **Mesh Role**—Role of the OAW-IAP as a mesh portal or mesh point.
- **Zone**—OAW-IAP zone.
- **Serial number**—Serial number of the device.
- **Channel**—Channel on which the OAW-IAP is currently broadcast.
- **Power (dB)**—Maximum transmission EIRP of the radio.
- **Utilization (%)**—Percentage of time that the channel is utilized.
- **Noise (dBm)**—Noise floor of the channel.

An **edit** link is displayed on clicking the OAW-IAP name. For details on editing OAW-IAP settings, see [Customizing OAW-IAP Settings on page 73](#).

Clients Tab

This tab displays a list of clients that are connected to the AOS-W Instant network. The client names are displayed as links. The expanded view displays the following information about each client:

- **Name**—Username of the client or guest users if available.
- **IP Address**—IP address of the client.

- **MAC Address**—MAC address of the client.
- **OS**—Operating system that runs on the client.
- **ESSID**—ESSID to which the client is connected.
- **Access Point**—OAW-IAP to which the client is connected.
- **Channel**—The client operating channel.
- **Type**—Type of the Wi-Fi client.
- **Role**—Role assigned to the client.
- **IPv6 Address**—IPv6 address assigned to the client.
- **Signal**—Current signal strength of the client, as detected by the OAW-IAP.
- **Speed (Mbps)**—Current speed at which data is transmitted. When the client is associated with an OAW-IAP, it constantly negotiates the speed of data transfer. A value of 0 means that the OAW-IAP has not heard from the client for some time.

Links

The following links allow you to configure various features for the AOS-W Instant network:

- [New Version Available](#)
- [System](#)
- [RF](#)
- [Security](#)
- [Maintenance](#)
- [More](#)
- [Help](#)
- [Logout](#)
- [Monitoring](#)
- [Client Match](#)
- [AppRF](#)
- [Spectrum](#)
- [Alerts](#)
- [IDS](#)
- [AirGroup](#)
- [Configuration](#)
- [OmniVista 3600 Air Manager 3600 Setup](#)
- [Pause/Resume](#)

Each of these links is explained in the subsequent sections.

New Version Available

This link is displayed on the AOS-W Instant main window only if a new image version is available on the image server and OmniVista 3600 Air Manager is not configured. For more information on the **New version available** link and its functions, refer to the *Alcatel-Lucent AOS-W Instant Release Notes*.

System

This link displays the **System** window. The **System** window consists of the following tabs:



Use the **Show/Hide Advanced** option of the **System** window to view or hide the advanced options.

- **General**—Allows you to configure, view, or edit the Name, IP address, NTP Server, and other OAW-IAP settings for the virtual switch.
- **Admin**—Allows you to configure administrator credentials for access to the virtual switch management UI. You can also configure OmniVista 3600 Air Manager in this tab. For more information on management interface and OmniVista 3600 Air Manager configuration, see [Managing OAW-IAP Users on page 185](#) and [Managing an OAW-IAP from OmniVista 3600 Air Manager on page 412](#), respectively.
- **Uplink**—Allows you to view or configure uplink settings. See [Uplink Configuration on page 424](#) for more information.
- **L3 Mobility**—Allows you to view or configure the Layer-3 mobility settings. See [Configuring Layer-3 Mobility on page 450](#) for more information.
- **Enterprise Domains**—Allows you to view or configure the DNS domain names that are valid in the enterprise network. See [Configuring Enterprise Domains on page 256](#) for more information.
- **Monitoring**—Allows you to view or configure the following details:
 - **Syslog**—Allows you to view or configure Syslog server details for sending syslog messages to the external servers. See [Configuring a Syslog Server on page 478](#) for more information.
 - **TFTP Dump**—Allows you to view or configure a TFTP dump server for core dump files. See [Configuring TFTP Dump Server on page 480](#) for more information.
 - **SNMP**—Allows you to view or configure SNMP agent settings. See [Configuring SNMP on page 474](#) for more information.
- **WISPr**—Allows you to view or configure the WISPr settings. See [Configuring WISPr Authentication on page 231](#) for more information.
- **Proxy**—Allows you to configure HTTP proxy on an OAW-IAP. Refer to the *Alcatel-Lucent AOS-W Instant Release Notes* for more information.
- **Time Based Services**—Allows you to configure a time profile which can be assigned to the SSID configured on the OAW-IAP. See [Configuring Time-Based Services on page 292](#)

RF

The **RF** link displays a window for configuring ARM and Radio features.

- **ARM**—Allows you to view or configure channel and power settings for all the OAW-IAPs in the network. For information on ARM configuration, see [ARM Overview on page 344](#).
- **Radio**—Allows you to view or configure radio settings for 2.4 GHz and the 5 GHz radio profiles. For information on Radio, see [Configuring Radio Settings on page 354](#).

Security

The **Security** link displays a window with the following tabs:

- **Authentication Servers**—Use this tab to configure an external RADIUS server for a wireless network. For more information, see [Configuring an External Server for Authentication on page 198](#).
- **Users for Internal Server**—Use this tab to populate the system's internal authentication server with users. This list is used by networks for which per-user authorization is specified using the internal authentication server of the virtual switch. For more information on users, see [Managing OAW-IAP Users on page 185](#).
- **Roles**—Use this tab to view the roles defined for all the Networks. The Access Rules part allows you to configure permissions for each role. For more information, see [Configuring User Roles on page 260](#) and [Configuring ACL Rules for Network Services on page 240](#).
- **Blacklisting**—Use this tab to blacklist clients. For more information, see [Blacklisting Clients on page 232](#).

- **Firewall Settings**—Use this tab to enable or disable ALG supporting address and port translation for various protocols and to configure protection against wired attacks. For more information, see [Configuring ALG Protocols on page 247](#) and [Configuring Firewall Settings for Protection from ARP Attacks on page 248](#)
- **Inbound Firewall**—Use this tab to enhance the inbound firewall by allowing the configuration of inbound firewall rules, management subnets, and restricted corporate access through an uplink switch. For more information, see [Managing Inbound Traffic on page 250](#).
- **Walled Garden**—Use this tab to allow or prevent access to a selected list of websites. For more information, see [Configuring Walled Garden Access on page 183](#).
- **External Captive Portal**—Use this tab to configure external captive portal profiles. For more information, see [Configuring External Captive Portal for a Guest Network on page 166](#).
- **Custom Blocked Page URL**—Use this tab to create a list of URLs that can be blocked using an ACL rule. For more information, see [Creating Custom Error Page for Web Access Blocked by AppRF Policies on page 258](#).

Maintenance

The **Maintenance** link displays a window that allows you to maintain the Wi-Fi network. The **Maintenance** window consists of the following tabs:

- **About**—Displays the name of the product, build time, OAW-IAP model name, the AOS-W Instant version, website address of Alcatel-Lucent, and copyright information.
- **Configuration**—Displays the following details:
 - **Current Configuration**—Displays the current configuration details.
 - **Clear Configuration**—Allows you to clear the current configuration details of the network. Select the **Remove all configurations including per-AP settings and certificates** checkbox to remove the per-AP settings and certificates as well.

The **Remove all configurations including per-AP settings and certificates** option is applicable only to clear configurations. It is not applicable to backup and restore configurations.

- **Backup Configuration**—Allows you to back up local configuration details. The backed up configuration data is saved in the file named **instant.cfg**.
- **Restore Configuration**—Allows you to restore the backed up configuration. After restoring the configuration, the OAW-IAP must be rebooted for the changes to take effect.
- **Certificates**—Displays information about the certificates installed on the OAW-IAP. You can also upload new certificates to the OAW-IAP database. For more information, see [Uploading Certificates on page 235](#).
- **Firmware**—Displays the current firmware version and provides various options to upgrade to a new firmware version. For more information, refer to the *Alcatel-Lucent AOS-W Instant Release Notes*.
- **Reboot**—Displays the OAW-IAPs in the network and provides an option to reboot the required OAW-IAP or all OAW-IAPs. For more information, refer to the *Alcatel-Lucent AOS-W Instant Release Notes*.
- **Convert**—Provides an option to convert an OAW-IAP to an OmniAccess Mobility Controller managed OAW-RAP or OAW-AP, or to the default virtual switch mode. For more information, see [Converting an OAW-IAP to a OAW-RAP and OAW-AP on page 465](#).
- **DRT**—Displays the DRT version running in an OAW-IAP. The DRT window contains the following sections:
 - **Manual**—Displays the current DRT version of the OAW-IAP. You can manually upgrade the DRT version by uploading a DRT file or by entering the URL.
 - **Reset**—Resets the DRT version.
 - **Automatic**—Enables an automatic DRT version upgrade.

More

The **More** link allows you to select the following options:

- [Tunneling](#)
- [Routing](#)
- [IDS](#)
- [Wired](#)
- [Services](#)
- [DHCP Server](#)
- [Support](#)

Tunneling

The **Tunneling** window displays the following list of parameters:

- **Controller**—Allows you to configure VPN protocols for remote access. See [Understanding VPN Features on page 297](#) for more information.
- **Enterprise Domains**—Allows you to view or configure the DNS domain names that are valid in the enterprise network. See [Configuring Enterprise Domains on page 256](#) for more information.

Routing

The **Routing** window displays the following list of parameters:

- **Destination**—Lists the destination network that is reachable through the VPN tunnel.
- **Netmask**—Lists the subnet mask to the destination.
- **Gateway**—Lists the gateway to which the traffic must be routed.
- **Metric**—Lists a metric value for the datapath route.

IDS

The **IDS** window allows you to configure wireless intrusion detection and protection levels.

For more information on wireless intrusion detection and protection, see [Detecting and Classifying Rogue OAW-IAPs on page 436](#).

Wired

The **Wired** window allows you to configure a wired network profile. See [Wired Profiles on page 134](#) for more information.

Services

The **Services** window allows you to configure services such as AirGroup, RTLS, and OpenDNS. The Services window consists of the following tabs:

- **AirGroup**—Allows you to configure the AirGroup and AirGroup services. For more information, see [Configuring AirGroup on page 377](#).
- **RTLS**—Allows you to integrate AMP or third-party RTLS such as Aeroscout RTLS with AOS-W Instant. For more information, see [Configuring an OAW-IAP for RTLS Support on page 386](#).
The RTLS tab also allows you to integrate OAW-IAP with the ALE. For more information about configuring an OAW-IAP for ALE integration, see [Configuring an OAW-IAP for ALE Support on page 388](#).
- **OpenDNS**—Allows you to configure support for OpenDNS business solutions, which require an OpenDNS (www.opendns.com) account. The OpenDNS credentials are used by AOS-W Instant and OmniVista 3600 Air Manager to filter content at the enterprise level. For more information, see [Configuring OpenDNS Credentials on page 393](#).

- **CALEA**—Allows you configure support for CALEA server integration, thereby ensuring compliance with Lawful Intercept and CALEA specifications. For more information, see [CALEA Integration and Lawful Intercept Compliance on page 399](#).
- **Network Integration**—Allows you to configure an OAW-IAP for integration with Palo Alto Networks Firewall and XML API server. For more information on OAW-IAP integration with PAN, see [Integrating an OAW-IAP with Palo Alto Networks Firewall on page 393](#) and [Integrating an OAW-IAP with an XML API Interface on page 395](#).
- **Dynamic DNS**—Allows you to configure dynamic DNS on Distributed L3 clients. For more information on Dynamic DNS, see [Dynamic DNS Registration on page 307](#).
- **Clarity**—Allows you to configure Clarity Live for generating inline monitoring statistics. For more information, see [Clarity Live on page 391](#).
- **Openflow**—Allows you to configure OpenFlow services on the OAW-IAP. For more information, see [SDN on page 1](#).
- **IoT**—Allows you to configure IoT endpoints on the OAW-IAP. For more information, see [BLE IoT for Data Communication on page 403](#).

DHCP Server

The **DHCP Servers** window allows you to configure various DHCP modes. For more information, see [DHCP Configuration on page 276](#).

Support

The **Support** link consists of the following details:

- **Command**—Allows you to select a support command for execution.
- **Target**—Displays a list of OAW-IAPs in the network.
- **Run**—Allows you to execute the selected command for a specific OAW-IAP or all OAW-IAPs and view logs.
- **Auto Run**—Allows you to configure a schedule for automatic execution of a support command for a specific OAW-IAP or all OAW-IAPs.
- **Filter**—Allows you to filter the contents of a command output.
- **Clear**—Clears the command output that is displayed after a command is executed.
- **Save**—Allows you to save the support command logs as an HTML or text file.

For more information on support commands, see [Running Debug Commands on page 481](#).

Help

The **Help** link allows you to view a short description or definition of the selected terms in the UI windows or the dialog boxes.

To activate the context-sensitive help:

1. Click the **Help** link available above the Search bar on the AOS-W Instant main window.
2. Click any text or term displayed in green italics to view its description or definition.
3. To disable the help mode, click **Done**.

Logout

The **Logout** link allows you to log out of the AOS-W Instant UI.

Monitoring

The **Monitoring** link displays the Monitoring pane for the AOS-W Instant network. Use the down arrow located to the right side of these links to compress or expand the Monitoring pane.

The Monitoring pane consists of the following sections:

- [Info](#)
- [RF Dashboard](#)
- [RF Trends](#)
- [Usage Trends](#)
- [Mobility Trail](#)

Info

The **Info** section displays the configuration information of the virtual switch by default. On selecting the **Network View** tab, the monitoring pane displays configuration information of the selected network. Similarly, in the **Access Point** or the **Client** view, this section displays the configuration information of the selected OAW-IAP or the client.

Table 10: Contents of the Info Section in the AOS-W Instant Main Window

Name	Description
<p>Info section in the Virtual Controller view</p>	<p>The Info section in the Virtual Controller view displays the following information:</p> <ul style="list-style-type: none"> ■ Name—Displays the virtual switch name. ■ Country Code—Displays the Country in which the virtual switch is operating. ■ Virtual Controller IP address—Displays the IP address of the virtual switch. ■ VC DNS—Displays the DNS IP address configured for the virtual switch. ■ Management—Indicates if the OAW-IAP is managed locally or through OmniVista 3600 Air Manager. ■ Master—Displays the IP address of the OAW-IAP acting as virtual switch. ■ OpenDNS Status—Displays the OpenDNS status. If the OpenDNS status indicates Not Connected, ensure that the network connection is up and appropriate credentials are configured for OpenDNS. ■ MAS integration—Displays the status of the Mobility Access Switch integration feature. ■ Uplink type—Displays the type of uplink configured on the OAW-IAP, for example, Ethernet or 3G. ■ Uplink status—Indicates the uplink status. ■ Blacklisted clients—Displays the number of blacklisted clients. ■ Internal RADIUS Users—Displays the number of internal RADIUS users. ■ Internal Guest Users—Displays the number of internal guest users. ■ Internal User Open Slots—Displays the available slots for user configuration as supported by the OAW-IAP model.
<p>Info section in the Network view</p>	<p>The Info section in the Network view displays the following information:</p> <ul style="list-style-type: none"> ■ Name—Displays the name of the network. ■ Status—Displays the status of the network. ■ Type—Displays the type of network, for example, Employee, Guest, or Voice. ■ VLAN—Displays VLAN details. ■ IP Assignment—Indicates if the OAW-IAP clients are assigned IP address from the network that the virtual switch is connected to, or from an internal autogenerated IP scope from the virtual switch. ■ Access—Indicates the level of access control configured for the network. ■ WMM DSCP—Displays WMM DSCP mapping details. ■ Security level—Indicates the type of user authentication and data encryption configured for the network. <p>The info section for WLAN SSIDs also indicates status of captive portal and CALEA ACLs and provides a link to upload certificates for the internal server. For more information, see Uploading Certificates on page 235.</p>
<p>Info section in the Access Point view</p>	<p>The Info section in the Access Point view displays the following information:</p> <ul style="list-style-type: none"> ■ Name—Displays the name of the selected OAW-IAP. ■ IP Address—Displays the IP address of the OAW-IAP. ■ Mode—Displays the mode in which the OAW-IAP is configured to operate. ■ Spectrum—Displays the status of the spectrum monitor. ■ Clients—Number of clients associated with the OAW-IAP. ■ Type—Displays the model number of the OAW-IAP. ■ Zone—Displays OAW-IAP zone details. ■ CPU Utilization—Displays the CPU utilization in percentage. ■ Memory Free—Displays the memory availability of the OAW-IAP in MB. ■ Serial number—Displays the serial number of the OAW-IAP. ■ MAC—Displays the MAC address. ■ From Port—Displays the port from where the slave OAW-IAP is learned in hierarchy mode.
<p>Info section in the Client view</p>	<p>The Info section in the Client view displays the following information:</p>

Table 10: Contents of the Info Section in the AOS-W Instant Main Window

Name	Description
	<ul style="list-style-type: none"> ■ Name—Displays the name of the client. ■ IP Address—Displays the IP address of the client. ■ MAC Address—Displays MAC address of the client. ■ OS—Displays the operating system that is running on the client. ■ ESSID—Indicates the network to which the client is connected. ■ Access Point—Indicates the OAW-IAP to which the client is connected. ■ Channel—Indicates the channel that is currently used by the client. ■ Type—Displays the channel type on which the client is broadcasting. ■ Role—Displays the role assigned to the client.

RF Dashboard

The **RF Dashboard** section lists the OAW-IAPs that exceed the utilization, noise, or error threshold. It also shows the clients with low speed or signal strength in the network and the RF information for the OAW-IAP to which the client is connected.

The OAW-IAP names are displayed as links. When an OAW-IAP is clicked, the OAW-IAP configuration information is displayed in the Info section and the RF Dashboard section is displayed on the AOS-W Instant main window.

The following table describes the icons available on the RF Dashboard pane:

Table 11: RF Dashboard Icons

Icon number	Name	Description
1	Signal	<p>Displays the signal strength of the client. Signal strength is measured in dB. Depending on the signal strength of the client, the color of the lines on the Signal icon changes in the following order:</p> <ul style="list-style-type: none"> ■ Green—Signal strength is more than 20 dB. ■ Orange—Signal strength is between 15 dB and 20 dB. ■ Red—Signal strength is less than 15 dB. <p>To view the signal graph for a client, click the signal icon next to the client in the Signal column.</p>
2	Speed	<p>Displays the data transfer speed of the client. Depending on the data transfer speed of the client, the color of the Speed icon changes in the following order:</p> <ul style="list-style-type: none"> ■ Green—Data transfer speed is more than 50% of the maximum speed supported by the client. ■ Orange—Data transfer speed is between 25% and 50% of the maximum speed supported by the client. ■ Red—Data transfer speed is less than 25% of the maximum speed supported by the client. <p>To view the data transfer speed graph of a client, click the speed icon corresponding to the client name in the Speed column.</p>
3	Utilization	<p>Displays the radio utilization rate of the OAW-IAPs. Depending on the percentage of utilization, the color of the lines on the Utilization icon changes in the following order:</p> <ul style="list-style-type: none"> ■ Green—Utilization is less than 50%. ■ Orange—Utilization is between 50% and 75%. ■ Red—Utilization is more than 75%. <p>To view the utilization graph of an OAW-IAP, click the Utilization icon next to the OAW-IAP in the Utilization column.</p>

Table 11: *RF Dashboard Icons*

Icon number	Name	Description
4	Noise	<p>Displays the noise floor details for the OAW-IAPs. Noise is measured in decibel per meter. Depending on the noise floor, the color of the lines on the Noise icon changes in the following order:</p> <ul style="list-style-type: none">■ Green—Noise floor is more than -87 dBm.■ Orange—Noise floor is between -80 dBm and -87 dBm.■ Red—Noise floor is less than -80 dBm. <p>To view the noise floor graph of an OAW-IAP, click the Noise icon next to the OAW-IAP in the Noise column.</p>
5	Errors	<p>Displays the errors for the OAW-IAPs. Depending on the errors, color of the lines on the Errors icon changes in the following order:</p> <ul style="list-style-type: none">■ Green—Errors are less than 5000 frames per second.■ Orange—Errors are between 5000 and 10,000 frames per second.■ Red—Errors are more than 10000 frames per second. <p>To view the errors graph of an OAW-IAP, click the Errors icon next to the OAW-IAP in the Errors column.</p>

RF Trends

The **RF Trends** section displays the graphs for the selected OAW-IAP and the client. To view the details on the graphs, click the graphs and hover the mouse on a data point.

The following table describes the RF trends graphs available in the Client view:

Table 12: Client View—RF Trends Graphs and Monitoring Procedures

Graph Name	Description	Monitoring Procedure
Signal	<p>The Signal graph shows the signal strength of the client for the last 15 minutes. It is measured in dB.</p> <p>To see an enlarged view, click the graph. The enlarged view provides Last, Minimum, Maximum, and Average signal statistics of the client for the last 15 minutes.</p> <p>To see the exact signal strength at a particular time, move the cursor over the graph line.</p>	<p>To monitor the signal strength of the selected client for the last 15 minutes:</p> <ol style="list-style-type: none"> 1. Log in to the AOS-W Instant UI. The virtual switch view is displayed. This is the default view. 2. On the Clients tab, click the IP address of the client for which you want to monitor the signal strength. 3. Study the Signal graph in the RF Trends pane. For example, the graph shows that signal strength for the client is 54.0 dB at 12:23 hours.
Frames	<p>The Frames graph shows the In and Out frame rate per second of the client for the last 15 minutes. It also shows data for the Retry In and Retry Out frames.</p> <ul style="list-style-type: none"> ■ Outgoing frames—Outgoing frame traffic is displayed in green. It is shown above the median line. ■ Incoming frames—Incoming frame traffic is displayed in blue. It is shown below the median line. ■ Retry Out—Retries for the outgoing frames are displayed above the median line in black. ■ Retry In—Retries for the incoming frames are displayed below the median line in red. <p>To see an enlarged view, click the graph. The enlarged view provides Last, Minimum, Maximum, and Average statistics for the In, Out, Retries In, and Retries Out frames.</p> <p>To see the exact frames at a particular time, move the cursor over the graph line.</p>	<p>To monitor the In and Out frame rate per second and retry frames for the In and Out traffic, for the last 15 minutes:</p> <ol style="list-style-type: none"> 1. Log in to the AOS-W Instant UI. The virtual switch view is displayed. This is the default view. 2. On the Clients tab, click the IP address of the client for which you want to monitor the frames. 3. Study the Frames graph in the RF Trends pane. For example, the graph shows 4.0 frames per second for the client at 12:27 hours.
Speed	<p>The Speed graph shows the data transfer speed for the client. Data transfer is measured in Mbps.</p> <p>To see an enlarged view, click the graph. The enlarged view shows Last, Minimum, Maximum, and Average statistics of the client for the last 15 minutes.</p> <p>To see the exact speed at a particular time, move the cursor over the graph line.</p>	<p>To monitor the speed for the client for the last 15 minutes:</p> <ol style="list-style-type: none"> 1. Log in to the AOS-W Instant UI. The virtual switch view is displayed. This is the default view. 2. On the Clients tab, click the IP address of the client for which you want to monitor the speed. 3. Study the Speed graph in the RF Trends pane. For example, the graph shows that the data transfer speed at 12:26 hours is 240 Mbps.
Throughput	<p>The Throughput Graph shows the throughput of the selected client for the last 15 minutes.</p> <ul style="list-style-type: none"> ■ Outgoing traffic—Throughput for 	<p>To monitor the errors for the client for the last 15 minutes:</p> <ol style="list-style-type: none"> 1. Log in to the AOS-W Instant UI. The virtual switch view is displayed. This is the default view.

Table 12: Client View—RF Trends Graphs and Monitoring Procedures

Graph Name	Description	Monitoring Procedure
	<p>the outgoing traffic is displayed in green. It is shown above the median line.</p> <ul style="list-style-type: none">■ Incoming traffic—Throughput for the incoming traffic is displayed in blue. It is shown below the median line. <p>To see an enlarged view, click the graph. The enlarged view shows Last, Minimum, Maximum, and Average statistics for the incoming and outgoing traffic throughput of the client for the last 15 minutes.</p> <p>To see the exact throughput at a particular time, move the cursor over the graph line.</p>	<ol style="list-style-type: none">2. In the Clients tab, click the IP address of the client for which you want to monitor the throughput.3. Study the Throughput graph in the RF Trends pane. For example, the graph shows 1.0 Kbps outgoing traffic throughput for the client at 12:30 hours.

Usage Trends

The **Usage Trends** section displays the following graphs:

- **Clients**—In the default view, the Clients graph displays the number of clients that were associated with the virtual switch in the last 15 minutes. In Network view or the Access Point view, the graph displays the number of clients that were associated with the selected network or OAW-IAP in the last 15 minutes.
- **Throughput**—In the default view, the Throughput graph displays the incoming and outgoing throughput traffic for the virtual switch in the last 15 minutes. In the Network view or the Access Point view, the graph displays the incoming and outgoing throughput traffic for the selected network or OAW-IAP in the last 15 minutes.

The following table describes the graphs displayed in the Network view:

Table 13: Network View—Graphs and Monitoring Procedures

Graph Name	Description	Monitoring Procedure
Clients	<p>The Clients graph shows the number of clients associated with the network for the last 15 minutes.</p> <p>To see an enlarged view, click the graph.</p> <ul style="list-style-type: none"> ■ The enlarged view provides Last, Minimum, Maximum, and Average statistics for the number of clients associated with the virtual switch for the last 15 minutes. ■ To see the exact number of clients in the AOS-W Instant network at a particular time, move the cursor over the graph line. 	<p>To check the number of clients associated with the network for the last 15 minutes:</p> <ol style="list-style-type: none"> 1. Log in to the AOS-W Instant UI. The virtual switch view is displayed. This is the default view. 2. On the Network tab, click the network for which you want to check the client association. 3. Study the Clients graph in the Usage Trends pane. For example, the graph shows that one client is associated with the selected network at 12:00 hours.
Throughput	<p>The Throughput graph shows the throughput of the selected network for the last 15 minutes.</p> <ul style="list-style-type: none"> ■ Outgoing traffic—Throughput for the outgoing traffic is displayed in green. Outgoing traffic is shown above the median line. ■ Incoming traffic—Throughput for the incoming traffic is displayed in blue. Incoming traffic is shown below the median line. <p>To see an enlarged view, click the graph.</p> <ul style="list-style-type: none"> ■ The enlarged view provides Last, Minimum, Maximum, and Average statistics for the incoming and outgoing traffic throughput of the network for the last 15 minutes. <p>To see the exact throughput of the selected network at a particular time, move the cursor over the graph line.</p>	<p>To check the throughput of the selected network for the last 15 minutes,</p> <ol style="list-style-type: none"> 1. Log in to the AOS-W Instant UI. The virtual switch view is displayed. This is the default view. 2. On the Network tab, click the network for which you want to check the client association. 3. Study the Throughput graph in the Usage Trends pane. For example, the graph shows 22.0 Kbps incoming traffic throughput for the selected network at 12:03 hours.

The following table describes the graphs displayed in the Access Point view:

Table 14: Access Point View—Usage Trends and Monitoring Procedures

Graph Name	OAW-IAP Description	Monitoring Procedure
<p>Neighboring OAW-IAPs</p>	<p>The Neighboring OAW-IAPs graph shows the number of OAW-IAPs detected by the selected OAW-IAP:</p> <ul style="list-style-type: none"> ■ Valid OAW-IAPs: An OAW-IAP that is part of the enterprise providing WLAN service. ■ Interfering OAW-IAPs: An OAW-IAP that is seen in the RF environment but is not connected to the network. ■ Rogue OAW-IAPs: An unauthorized OAW-IAP that is plugged into the wired side of the network. <p>To see the number of different types of neighboring OAW-IAPs for the last 15 minutes, move the cursor over the respective graph lines.</p>	<p>To check the neighboring OAW-IAPs detected by the OAW-IAP for the last 15 minutes:</p> <ol style="list-style-type: none"> 1. Log in to the AOS-W Instant UI. The Virtual Controller view is displayed. This is the default view. 2. On the Access Points tab, click the OAW-IAP for which you want to monitor the client association. 3. Study the Neighboring OAW-IAPs graph in the Overview section. For example, the graph shows that 148 interfering OAW-IAPs are detected by the OAW-IAP at 12:04 hours.
<p>CPU Utilization</p>	<p>The CPU Utilization graph displays the utilization of CPU for the selected OAW-IAP.</p> <p>To see the CPU utilization of the OAW-IAP, move the cursor over the graph line.</p>	<p>To check the CPU utilization of the OAW-IAP for the last 15 minutes:</p> <ol style="list-style-type: none"> 1. Log in to the AOS-W Instant UI. The Virtual Controller view is displayed. This is the default view. 2. On the Access Points tab, click the OAW-IAP for which you want to monitor the client association. 3. Study the CPU Utilization graph in the Overview pane. For example, the graph shows that the CPU utilization of the OAW-IAP is 30% at 12:09 hours.
<p>Neighboring Clients</p>	<p>The Neighboring Clients graph shows the number of clients not connected to the selected OAW-IAP, but heard by it.</p> <ul style="list-style-type: none"> ■ Any client that successfully authenticates with a valid OAW-IAP and passes encrypted traffic is classified as a valid client. ■ Interfering: A client associated to any OAW-IAP and is not valid is classified as an interfering client. <p>To see the number of different types of neighboring clients for the last 15 minutes, move the cursor over the respective graph lines.</p>	<p>To check the neighboring clients detected by the OAW-IAP for the last 15 minutes,</p> <ol style="list-style-type: none"> 1. Log in to the AOS-W Instant UI. The Virtual Controller view is displayed. This is the default view. 2. On the Access Points tab, click the OAW-IAP for which you want to monitor the client association. 3. Study the Neighboring Clients graph in the Overview pane. For example, the graph shows that 20 interfering clients were detected by the OAW-IAP at 12:15 hours.

Table 14: Access Point View—Usage Trends and Monitoring Procedures

Graph Name	OAW-IAP Description	Monitoring Procedure
Memory free (MB)	<p>The Memory free graph displays the memory availability of the OAW-IAP in MB.</p> <p>To see the free memory of the OAW-IAP, move the cursor over the graph line.</p>	<p>To check the free memory of the OAW-IAP for the last 15 minutes:</p> <ol style="list-style-type: none"> 1. Log in to the AOS-W Instant UI. The Virtual Controller view is displayed. This is the default view. 2. On the Access Points tab, click the OAW-IAP for which you want to monitor the client association. 3. Study the Memory free graph in the Overview pane. For example, the graph shows that the free memory of the OAW-IAP is 64 MB at 12:13 hours.
Clients	<p>The Clients graph shows the number of clients associated with the selected OAW-IAP for the last 15 minutes.</p> <p>To see an enlarged view, click the graph. The enlarged view provides Last, Minimum, Maximum, and Average statistics for the number of clients associated with the OAW-IAP for the last 15 minutes.</p> <p>To see the exact number of clients associated with the selected OAW-IAP at a particular time, move the cursor over the graph line.</p>	<p>To check the number of clients associated with the OAW-IAP for the last 15 minutes:</p> <ol style="list-style-type: none"> 1. Log in to the AOS-W Instant UI. The Virtual Controller view is displayed. This is the default view. 2. On the Access Points tab, click the OAW-IAP for which you want to monitor the client association. 3. Study the Clients graph. For example, the graph shows that six clients are associated with the OAW-IAP at 12:11 hours.
Throughput	<p>The Throughput graph shows the throughput for the selected OAW-IAP for the last 15 minutes.</p> <ul style="list-style-type: none"> ■ Outgoing traffic—Throughput for the outgoing traffic is displayed in green. It is shown above the median line. ■ Incoming traffic—Throughput for the incoming traffic is displayed in blue. It is shown below the median line. <p>To see an enlarged view, click the graph.</p> <ul style="list-style-type: none"> ■ The enlarged view provides Last, Minimum, Maximum, and Average statistics for the incoming and outgoing traffic throughput of the OAW-IAP for the last 15 minutes. <p>To see the exact throughput of the selected OAW-IAP at a particular time, move the cursor over the graph line.</p>	<p>To check the throughput of the selected OAW-IAP for the last 15 minutes:</p> <ol style="list-style-type: none"> 1. Log in to the AOS-W Instant UI. The Virtual Controller view is displayed. This is the default view. 2. On the Access Points tab, click the OAW-IAP for which you want to monitor the throughput. 3. Study the Throughput graph. For example, the graph shows 44.03 Kbps incoming traffic throughput at 12:08 hours.

Mobility Trail

The **Mobility Trail** section displays the following mobility trail information for the selected client:

- **Association Time**—The time at which the selected client was associated with a particular OAW-IAP. The AOS-W Instant UI shows the client and OAW-IAP association over the last 15 minutes.
- **Access Point**—The OAW-IAP name with which the client was associated.



Mobility information about the client is reset each time it roams from one OAW-IAP to another.

Client Match

If Client Match is enabled, the **Client Match** link provides a graphical representation of radio map view of an OAW-IAP and the client distribution on an OAW-IAP radio.

On clicking an access point in the **Access Points** tab and the **Client Match** link, a stations map view is displayed and a graph is drawn with real-time data points for the OAW-IAP radio. If the OAW-IAP supports dual-band, you can toggle between 2.4 GHz and 5 GHz links in the Client Match graph area to view the data. When you hover the mouse on the graph, details such as RSSI, Client Match status, and the client distribution on channels are displayed.

On clicking a client in the **Clients** tab and the **Client Match** link, a graph is drawn with real-time data points for an OAW-IAP radio map. When you hover the mouse on the graph, details such as RSSI, channel utilization details, and client count on each channel are displayed.

AppRF

The **AppRF** link displays the application traffic summary for OAW-IAPs and client devices. The **AppRF** link in the activity panel is displayed only if **AppRF visibility** is enabled in the **System** window. For more information on application visibility and AppRF charts, see [Application Visibility on page 361](#).

Spectrum

The spectrum link (in **Access Point** view) displays the spectrum data that is collected by a hybrid OAW-IAP or by an OAW-IAP that has enabled spectrum monitor. The spectrum data is not reported to the virtual switch.

The spectrum link displays the following:

- **Device list**—The device list display consists of a device summary table and channel information for active non Wi-Fi devices currently seen by a spectrum monitor or a hybrid OAW-IAP radio.
- **Channel Utilization and Monitoring**—This chart provides an overview of channel quality across the spectrum. It shows channel utilization information such as channel quality, availability, and utilization metrics as seen by a spectrum monitor for the 2.4 GHz and 5 GHz radio bands. The first bar for each channel represents the percentage of airtime used by non-Wi-Fi interference and Wi-Fi devices. The second bar indicates the channel quality. A higher percentage value indicates better quality.
- **Channel Details**—When you move your mouse over a channel, the channel details or the summary of the 2.4 GHz and 5 GHz channels as detected by a spectrum monitor are displayed. You can view the aggregate data for each channel seen by the spectrum monitor radio, including the maximum OAW-IAP power, interference, and the SNIR. Spectrum monitors display spectrum analysis data seen on all channels in the selected band, and hybrid OAW-IAPs display data from the single channel that they are monitoring.

For more information on spectrum monitoring, see [Spectrum Monitor on page 452](#).

Alerts

Alerts are generated when a user encounters problems while accessing or connecting to a network. The alerts that are generated can be categorized as follows:

- 802.11-related association and authentication failure alerts
- 802.1X-related mode and key mismatch, server, and client time-out failure alerts
- IP-address-related failures—Static IP address or DHCP-related alerts.

The **Alerts** link displays the following types of alerts:

- Client Alerts
- Active Faults
- Fault History

Table 15: *Types of Alerts*

Type of Alert	Description	Information Displayed
Client Alerts	The alert type, Client Alerts , occur when clients are connected to the AOS-W Instant network.	The alert type, Client Alert displays the following information: <ul style="list-style-type: none"> ■ Timestamp—Displays the time at which the client alert was recorded. ■ MAC address—Displays the MAC address of the client that caused the alert. ■ Description—Provides a short description of the alert. ■ Access Points—Displays the IP address of the OAW-IAP to which the client is connected. ■ Details—Provides complete details of the alert.
Active Faults	The Active Faults alerts occur in the event of a system fault.	The Active Faults alerts consists of the following information: <ul style="list-style-type: none"> ■ Time—Displays the system time when an event occurs. ■ Number—Indicates the number of sequence. ■ Description—Displays the event details.
Fault History	The Fault History alerts display the historic system faults.	The Fault History alert displays the following information: <ul style="list-style-type: none"> ■ Time—Displays the system time when an event occurs. ■ Number—Indicates the number of sequence. ■ Cleared by—Displays the module which cleared this fault. ■ Description—Displays the event details.

The following table displays a list of alerts that are generated in the OAW-IAP network:

Table 16: *Alerts List*

Description Code	Description	Details	Corrective Actions
100101	Internal error	The OAW-IAP has encountered an internal error for this client.	Contact the Alcatel-Lucent customer support team.
100102	Unknown SSID in association request	The OAW-IAP cannot allow this client to associate because the association request received contains an unknown SSID.	Identify the client and check its Wi-Fi driver and manager software.
100103	Mismatched authentication or encryption setting	The OAW-IAP cannot allow this client to associate because its authentication or encryption settings do not match AP's configuration.	Ascertain the correct authentication or encryption settings and try to associate again.
100104	Unsupported 802.11 rate	The OAW-IAP cannot allow this client to associate because it does not support the 802.11 rate requested by this client.	Check the configuration on the OAW-IAP to see if the desired rate can be supported; if not, consider replacing the OAW-IAP with another model that can support the rate.

Table 16: Alerts List

Description Code	Description	Details	Corrective Actions
100105	Maximum capacity reached on OAW-IAP	The OAW-IAP has reached maximum capacity and cannot accommodate any more clients.	Consider expanding capacity by installing additional OAW-IAPs or balance load by relocating OAW-IAPs.
100206	Invalid MAC Address	The OAW-IAP cannot authenticate this client because its MAC address is not valid.	This condition may be indicative of a misbehaving client. Try to locate the client device and check its hardware and software.
100307	Client blocked due to repeated authentication failures	The OAW-IAP is temporarily blocking the 802.1X authentication request from this client because the credentials provided have been rejected by the RADIUS server too many times.	Identify the client and check its 802.1X credentials.
100308	RADIUS server connection failure	The OAW-IAP cannot authenticate this client using 802.1X because the RADIUS server did not respond to the authentication request. If the OAW-IAP is using the internal RADIUS server, it is recommend to check the related configuration as well as the installed certificate and passphrase.	If the OAW-IAP is using the internal RADIUS server, Alcatel-Lucent recommends checking the related configuration as well as the installed certificate and passphrase. If the OAW-IAP is using an external RADIUS server, check if there are any issues with the RADIUS server and try connecting again.
100309	RADIUS server authentication failure	The OAW-IAP cannot authenticate this client using 802.1X, because the RADIUS server rejected the authentication credentials (for example, password) provided by the client.	Ascertain the correct authentication credentials and log in again.
100410	Integrity check failure in encrypted message	The OAW-IAP cannot receive data from this client because the integrity check of the received message has failed. Recommend checking the encryption setting on the client and on the OAW-IAP.	Check the encryption setting on the client and on the OAW-IAP.
100511	DHCP request timed out	This client did not receive a response to its DHCP request in time. Recommend checking the status of the DHCP server in the network.	Check the status of the DHCP server in the network.
101012	Wrong Client VLAN	VLAN mismatch between the OAW-IAP and the upstream device. Upstream device can be upstream switch or RADIUS server.	

IDS

The **IDS** link displays a list of foreign OAW-IAPs and foreign clients that are detected in the network. It consists of the following sections:

- **Foreign Access Points Detected**—Lists the OAW-IAPs that are not controlled by the virtual switch. The following information is displayed for each foreign OAW-IAP:
 - **MAC address**—Displays the MAC address of the foreign OAW-IAP.
 - **Network**—Displays the name of the network to which the foreign OAW-IAP is connected.
 - **Classification**—Displays the classification of the foreign OAW-IAP, for example, Interfering OAW-IAP or Rogue OAW-IAP.
 - **Channel**—Displays the channel in which the foreign OAW-IAP is operating.
 - **Type**—Displays the Wi-Fi type of the foreign OAW-IAP.
 - **Last seen**—Displays the time when the foreign OAW-IAP was last detected in the network.
 - **Where**—Provides information about the OAW-IAP that detected the foreign OAW-IAP. Click the push pin icon to view the information.
- **Foreign Clients Detected**— Lists the clients that are not controlled by the virtual switch. The following information is displayed for each foreign client:
 - **MAC address**—Displays the MAC address of the foreign client.
 - **Network**—Displays the name of the network to which the foreign client is connected.
 - **Classification**—Displays the classification of the foreign client: Interfering client.
 - **Channel**—Displays the channel in which the foreign client is operating.
 - **Type**—Displays the Wi-Fi type of the foreign client.
 - **Last seen**—Displays the time when the foreign client was last detected in the network.
 - **Where**—Provides information about the OAW-IAP that detected the foreign client. Click the Push Pin icon to view the information.

For more information on the intrusion detection feature, see [Intrusion Detection on page 436](#).

AirGroup

This **AirGroup** link provides an overall view of your AirGroup configuration. Click each parameter to view or edit the settings.

- **MAC**—Displays the MAC address of the AirGroup servers.
- **IP**—Displays the IP address of the AirGroup servers.
- **Host Name**—Displays the machine name or host name of the AirGroup servers.
- **Service**— Displays the type of services such as AirPlay or AirPrint.
- **VLAN**—Displays VLAN details of the AirGroup servers.
- **Wired/Wireless**—Displays if the AirGroup server is connected through a wired or wireless interface.
- **Role**—Displays the user role if the server is connected through 802.1X authentication. If the server is connected through phase-shift keying or open authentication, this parameter is blank.
- **Group**—Displays the group.
- **CPPM**—By clicking this, you get details of the registered rules in ClearPass Policy Manager for this server.
- **MDNS Cache**—By clicking this, you receive MDNS record details of a particular server.

Configuration

The **Configuration** link provides an overall view of your virtual switch, OAW-IAPs, and WLAN SSID configuration.

OmniVista 3600 Air Manager 3600 Setup

OmniVista 3600 Air Manager is a solution for managing rapidly changing wireless networks. When enabled, OmniVista 3600 Air Manager allows you to manage the AOS-W Instant network. For more information on OmniVista 3600 Air Manager, see [Managing an OAW-IAP from OmniVista 3600 Air Manager on page 412](#). The OmniVista 3600 Air Manager status is displayed below the virtual switch section of the AOS-W Instant main window. If the OmniVista 3600 Air Manager status is **Not Set Up**, click the **Set Up Now** link to configure OmniVista 3600 Air Manager. The **System > Admin** window is displayed.

Pause/Resume

The **Pause/Resume** link is located on the AOS-W Instant main window.

The AOS-W Instant UI is automatically refreshed every 15 seconds by default. Click the **Pause** link to pause the automatic refreshing of the AOS-W Instant UI after every 15 seconds. When the automatic refreshing is paused, the **Pause** link changes to **Resume**. Click the **Resume** link to resume automatic refreshing.

Automatic refreshing allows you to get the latest information about the network and network elements. You can use the **Pause** link when you want to analyze or monitor the network or a network element, and therefore do not want the UI to refresh.

Views

Depending on the link or tab that is clicked, AOS-W Instant displays information about the virtual switch, Wi-Fi networks, OAW-IAPs, or the clients in the Info section. The views on the AOS-W Instant main window are classified as follows:

- **Virtual Controller** view—The virtual switch view is the default view. This view allows you to monitor the AOS-W Instant network.
- The following WebUI elements are available in this view:
 - **Tabs**—Networks, Access Points, and Clients. For detailed information on the tabs, see [Tabs on page 33](#).
 - **Links**—Monitoring, Client Alerts, and IDS. The Spectrum link is visible if you have configured the OAW-IAP as a spectrum monitor. These links allow you to monitor the AOS-W Instant network. For more information on these links, see [Monitoring on page 39](#), [IDS on page 52](#), [Alerts on page 49](#), and [Spectrum Monitor on page 452](#).
- **Network** view—The Network view provides information that is necessary to monitor a selected wireless network. All Wi-Fi networks in the AOS-W Instant network are listed in the **Network** tab. Click the name of the network that you want to monitor.
- AOS-W Instant Access Point view—The AOS-W Instant Access Point view provides information that is necessary to monitor a selected OAW-IAP. All OAW-IAPs in the AOS-W Instant network are listed in the **Access Points** tab. Click the name of the OAW-IAP that you want to monitor.
- **Client** view—The Client view provides information that is necessary to monitor a selected client. In the Client view, all the clients in the AOS-W Instant network are listed in the **Clients** tab. Click the IP address of the client that you want to monitor.

For more information on the graphs and the views, see [Monitoring on page 39](#).

This chapter describes the following sections:

- [Introduction on page 54](#)
- [Login Screen on page 54](#)
- [Main Window on page 55](#)

Introduction

The old AOS-W Instant WebUI is not fully aligned with the other products of Alcatel-Lucent. For an enhanced user experience, AOS-W Instant 8.4.0.0. introduces the new WebUI.

The key features of the new WebUI are that it has a modern look and feel with a responsive layout that is mobile and/or tablet friendly and it has an improvised search capability.

You can toggle between the old and new WebUI as and when required.

- If you are on the old WebUI and want to switch to the new WebUI, click the **Switch to new UI** link on the AOS-W Instant main window.
- If you are on the new WebUI and want to switch to the old WebUI, expand the User menu at the top right corner of the AOS-W Instant main window and click the **Switch to old UI** link.

Login Screen

The AOS-W Instant login page allows you to perform the following tasks:

- View AOS-W Instant Network Connectivity summary
- View the WebUI in a specific language
- Log in to the new WebUI

Viewing Connectivity Summary

The login page also displays the connectivity status to the AOS-W Instant network. The users can view a summary that indicates the status of the Internet availability, uplink, cellular modem and signal strength, VPN, and OmniVista 3600 Air Manager configuration details before logging in to the WebUI.

Language

The **Language** drop-down list contains the available languages and allows users to select their preferred language before logging in to the WebUI. A default language is selected based on the language preferences in the client desktop operating system or browser. If AOS-W Instant cannot detect the language, then **English** is used as the default language.

You can also select the required language option from the **Languages** drop-down list located on the AOS-W Instant main window.

Logging into the New WebUI

To log in to the WebUI, enter the following credentials:

- Username—admin

- Password—admin

The new WebUI main window is displayed.

Main Window

After you log in to AOS-W Instant, the new WebUI main window is displayed.

Figure 2 *AOS-W Instant New WebUI Main Window*

The horizontal pane of the main window is divided based on the following icons:

- **Alcatel-Lucent logo**—The Alcatel-Lucent logo.
- **Search**—Administrators can search for an OAW-IAP, client, or a network in the Search text box. When you type a search text, the search function suggests matching keywords and allows you to automatically complete the search text entry.
- **Notifications**—The Notifications link displays notifications about new updates with regard to the WebUI.
- **Help**—The Help link allows you to view a short description or definition of the selected terms in the WebUI windows or the dialog boxes.

To activate the context-sensitive help:

1. Click the Help link available above the Search bar on the AOS-W Instant main window.
2. Click any text or term displayed in green italics to view its description or definition.
3. To disable the help mode, click the Help link.

- **User menu**—Drop-down menu that displays your username, user settings, link to documentation, option to switch to the old WebUI, and an option to logout of the OAW-IAP.

The vertical pane of the main window consists of the following tabs:

- [Monitoring](#)
- [Configuration](#)
- [Maintenance](#)
- [Support](#)

Monitoring

The **Monitoring** tab displays the Monitoring pane for the AOS-W Instant network. Click the **Monitoring** tab to compress or expand the Monitoring pane.

The Monitoring pane consists of the following sections:

- Overview
- Networks
- Access Points
- Clients

Overview

This section displays the following sections:

- **Overview**—This section displays the number of configured networks, access points, and clients
- **Info**—This section displays information about the access point name, country code, virtual controller IP address, management, master OAW-IAP IP address, IPv6 address, uplink type, and uplink status.
- **Clients**—The Clients graph displays the number of clients that were associated with the virtual switch in the last 15 minutes.

- **Throughput**—The Throughput Graph shows the throughput of the selected client for the last 15 minutes.
 - **Out**—Throughput for the outgoing traffic is displayed in blue.
 - **In**—Throughput for the incoming traffic is displayed in orange. To see an enlarged view, click the graph. To see the exact throughput at a particular time, move the cursor over the graph line.
- **RF Dashboard**—This section displays the OAW-IAPs that exceed the utilization, noise, or error threshold. It also shows the clients with low speed or signal strength in the network and the RF information for the OAW-IAP to which the client is connected.

The OAW-IAP names are displayed as links. When an OAW-IAP is clicked, the OAW-IAP configuration information is displayed on the AOS-W Instant main window.

The following table describes the parameters available on the RF Dashboard pane:

Table 17: RF Dashboard Parameters

Parameter	Description
Signal	Displays the signal strength of the client. Signal strength is measured in dB. Depending on the signal strength of the client, the color of the lines on the Signal icon changes in the following order: <ul style="list-style-type: none"> ■ Green—Signal strength is more than 20 dB. ■ Orange—Signal strength is between 15 dB and 20 dB. ■ Red—Signal strength is less than 15 dB.
Speed	Displays the data transfer speed of the client. Depending on the data transfer speed of the client, the color of the Speed icon changes in the following order: <ul style="list-style-type: none"> ■ Green—Data transfer speed is more than 50% of the maximum speed supported by the client. ■ Orange—Data transfer speed is between 25% and 50% of the maximum speed supported by the client. ■ Red—Data transfer speed is less than 25% of the maximum speed supported by the client.
Utilization	Displays the radio utilization rate of the OAW-IAPs. Depending on the percentage of utilization, the color of the lines on the Utilization icon changes in the following order: <ul style="list-style-type: none"> ■ Green—Utilization is less than 50%. ■ Orange—Utilization is between 50% and 75%. ■ Red—Utilization is more than 75%.
Noise	Displays the noise floor details for the OAW-IAPs. Noise is measured in decibel per meter. Depending on the noise floor, the color of the lines on the Noise icon changes in the following order: <ul style="list-style-type: none"> ■ Green—Noise floor is more than -87 dBm. ■ Orange—Noise floor is between -80 dBm and -87 dBm. ■ Red—Noise floor is less than -80 dBm.
Errors	Displays the errors for the OAW-IAPs. Depending on the errors, color of the lines on the Errors icon changes in the following order: <ul style="list-style-type: none"> ■ Green—Errors are less than 5000 frames per second. ■ Orange—Errors are between 5000 and 10,000 frames per second. ■ Red—Errors are more than 10000 frames per second.

Networks

This section displays a list of Wi-Fi networks that are configured in the AOS-W Instant network. The network names are displayed as links. The expanded view displays the following information about each WLAN SSID:

- **Name**—Name of the network.
- **Clients**—Number of clients that are connected to the network.
- **Type**—Type of network such as Employee, Guest, or Voice.
- **Band**—Band in which the network is broadcast: 2.4 GHz band, 5 GHz band, or both.

- **Authentication Method**—Authentication method required to connect to the network.
- **Key Management**—Authentication key type.
- **IP Assignment**—Source of IP address for the client.
- **Zone**—OAW-IAP zone configured on the SSID.
- **Active**—Status of the network.

Access Points

If the Auto-Join Mode feature is enabled, a list of enabled and active OAW-IAPs in the AOS-W Instant network is displayed on the **Access Points** section. The OAW-IAP names are displayed as links.

The **Access Points** section displays the following information about each OAW-IAP:

- **Name**—Name of the OAW-IAP. If the OAW-IAP functions as a master OAW-IAP in the network, the asterisk sign "*" is displayed next to the OAW-IAP.
- **IP Address**—IP address of the OAW-IAP.
- **Mode**—Mode of the OAW-IAP.
 - **Access**—In this mode, the OAW-IAP serves clients and scans the home channel for spectrum analysis while monitoring channels for rogue OAW-IAPs in the background.
 - **Monitor**—In this mode, the OAW-IAP acts as a dedicated AM, scanning all channels for rogue OAW-IAPs and clients.
- **Spectrum**—When enabled, the OAW-IAP functions as a dedicated full-spectrum RF monitor, scanning all channels to detect interference from neighboring OAW-IAPs or non-Wi-Fi devices such as microwaves and cordless phones. When Spectrum is enabled, the OAW-IAP does not provide access services to clients.
- **Clients**—Number of clients that are currently associated to the OAW-IAP.
- **Type**—Model number of the OAW-IAP.
- **Mesh Role**—Role of the OAW-IAP as a mesh portal or mesh point.
- **Zone**—OAW-IAP zone.
- **Serial number**—Serial number of the device.

Clients

This section displays a list of clients that are connected to the AOS-W Instant network. The client names are displayed as links. The client view displays the following information about each client:

- **Name**—User name of the client or guest users if available.
- **IP Address**—IP address of the client.
- **MAC address**—MAC address of the client.
- **OS**—Operating system that runs on the client.
- **ESSID**—ESSID to which the client is connected.
- **Access Point**—OAW-IAP to which the client is connected.
- **Channel**—The client operating channel.
- **Type**—Type of the Wi-Fi client.
- **Role**—Role assigned to the client.
- **IPv6 Address**—IPv6 address assigned to the client.
- **Signal**—Current signal strength of the client, as detected by the OAW-IAP.
- **Speed (Mbps)**—Current speed at which data is transmitted. When the client is associated with an OAW-IAP, it constantly negotiates the speed of data transfer. A value of 0 means that the OAW-IAP has not heard from the client for some time.

Configuration

The following configurations allow you to configure various features for the AOS-W Instant network:

- Networks
- Access Points
- System
- RF
- Security
- IDS
- Routing
- Tunneling
- Services
- DHCP Server

Networks

The **Networks** section displays the following tabs:

- **Name**—Displays the name of a WLAN or a wired network profile.
- **Type**—Shows whether the configured network profile is a WLAN or a wired profile.
- **Clients**—Shows the number of clients associated with the network profile.

You can add, edit, or delete a network profile by clicking the corresponding icons.

Access Points

The **Access Points** section displays the following tabs:

- **Name**—Name of the OAW-IAP. If the OAW-IAP functions as a master OAW-IAP in the network, the asterisk sign "*" is displayed next to the OAW-IAP.
- **IP Address**—IP address of the OAW-IAP.
- **Mode**—Mode of the OAW-IAP.
 - **Access**—In this mode, the OAW-IAP serves clients and scans the home channel for spectrum analysis while monitoring channels for rogue OAW-IAPs in the background.
 - **Monitor**—In this mode, the OAW-IAP acts as a dedicated AM, scanning all channels for rogue OAW-IAPs and clients.
- **Spectrum**—When enabled, the OAW-IAP functions as a dedicated full-spectrum RF monitor, scanning all channels to detect interference from neighboring OAW-IAPs or non-Wi-Fi devices such as microwaves and cordless phones. When Spectrum is enabled, the OAW-IAP does not provide access services to clients.
- **Clients**—Number of clients that are currently associated to the OAW-IAP.
- **Type**—Model number of the OAW-IAP.
- **Mesh Role**—Role of the OAW-IAP as a mesh portal or mesh point.
- **Zone**—OAW-IAP zone.
- **Serial number**—Serial number of the device.

To edit a network profile, select the access point.

System

This **System** section displays the following tabs:



Use the **Show/Hide Advanced** option of the **System** window to view or hide the advanced options.

The **System** section displays the following tabs:

- **General**—Allows you to configure, view, or edit the Name, IP address, NTP Server, and other OAW-IAP settings for the virtual switch.
- **Admin**—Allows you to configure administrator credentials for access to the virtual switch management UI. You can also configure OmniVista 3600 Air Manager in this tab. For more information on management interface and OmniVista 3600 Air Manager configuration, see [Managing OAW-IAP Users on page 185](#) and [Managing an OAW-IAP from OmniVista 3600 Air Manager on page 412](#), respectively.
- **Uplink**—Allows you to view or configure uplink settings. See [Uplink Configuration on page 424](#) for more information.
- **L3 Mobility**—Allows you to view or configure the Layer-3 mobility settings. See [Configuring Layer-3 Mobility on page 450](#) for more information.
- **Monitoring**—Allows you to view or configure the following details:
 - **Syslog**—Allows you to view or configure Syslog server details for sending syslog messages to the external servers. See [Configuring a Syslog Server on page 478](#) for more information.
 - **TFTP Dump**—Allows you to view or configure a TFTP dump server for core dump files. See [Configuring TFTP Dump Server on page 480](#) for more information.
 - **SNMP**—Allows you to view or configure SNMP agent settings. See [Configuring SNMP on page 474](#) for more information.
- **WISPr**—Allows you to view or configure the WISPr settings. See [Configuring WISPr Authentication on page 231](#) for more information.
- **Proxy**—Allows you to configure HTTP proxy on an OAW-IAP. Refer to the *Alcatel-Lucent AOS-W Instant Release Notes* for more information.
- **Time Based Services**—Allows you to configure a time profile which can be assigned to the SSID configured on the OAW-IAP. See [Configuring Time-Based Services on page 292](#)

RF

The **RF** section displays a window for configuring ARM and Radio features.

- **ARM**—Allows you to view or configure channel and power settings for all the OAW-IAPs in the network. For information on ARM configuration, see [ARM Overview on page 344](#).
- **Radio**—Allows you to view or configure radio settings for 2.4 GHz and the 5 GHz radio profiles. For information on Radio, see [Configuring Radio Settings on page 354](#).

Security

The **Security** section displays a window with the following tabs:

- **Authentication Servers**—Use this tab to configure an external RADIUS server for a wireless network. For more information, see [Configuring an External Server for Authentication on page 198](#).
- **Users**—Use this tab to populate the system's internal authentication server with users. This list is used by networks for which per-user authorization is specified using the internal authentication server of the virtual switch. For more information on users, see [Managing OAW-IAP Users on page 185](#).
- **Roles**—Use this tab to view the roles defined for all the Networks. The Access Rules part allows you to configure permissions for each role. For more information, see [Configuring User Roles on page 260](#) and [Configuring ACL Rules for Network Services on page 240](#).
- **Blacklisting**—Use this tab to blacklist clients. For more information, see [Blacklisting Clients on page 232](#).
- **Firewall Settings**—Use this tab to enable or disable ALG supporting address and port translation for various protocols and to configure protection against wired attacks. For more information, see [Configuring ALG Protocols on page 247](#) and [Configuring Firewall Settings for Protection from ARP Attacks on page 248](#)

- **Inbound Firewall**—Use this tab to enhance the inbound firewall by allowing the configuration of inbound firewall rules, management subnets, and restricted corporate access through an uplink switch. For more information, see [Managing Inbound Traffic on page 250](#).
- **External Captive Portal**—Use this tab to configure external captive portal profiles. For more information, see [Configuring External Captive Portal for a Guest Network on page 166](#).
- **Custom Blocked Page URL**—Use this tab to create a list of URLs that can be blocked using an ACL rule. For more information, see [Creating Custom Error Page for Web Access Blocked by AppRF Policies on page 258](#).

IDS

The **IDS** section displays a list of foreign OAW-IAPs and foreign clients that are detected in the network. It consists of the following sections:

- **Detection**—Lists the threats for the OAW-IAP to detect.
 - **Infrastructure**—Specifies the policy for detecting wireless attacks on access points.
 - **Clients**—Specifies the policy for detecting wireless attacks on clients.
- **Protection**—Lists the threats for the OAW-IAP to protect.
 - **Infrastructure**—Specifies the policy for protecting clients from wireless attacks.
 - **Clients**—Prevents unauthorized stations from connecting to your AOS-W Instant network.

For more information on the intrusion detection feature, see [Intrusion Detection on page 436](#).

Routing

The **Routing** section displays the following list of parameters:

- **Destination**—Lists the destination network that is reachable through the VPN tunnel.
- **Netmask**—Lists the subnet mask to the destination.
- **Gateway**—Lists the gateway to which the traffic must be routed.
- **Metric**—Lists a metric value for the datapath route.

Tunneling

The **Tunneling** section displays the following list of parameters:

- **Controller**—Allows you to configure VPN protocols for remote access. See [Understanding VPN Features on page 297](#) for more information.
- **Enterprise Domains**—Allows you to view or configure the DNS domain names that are valid in the enterprise network. See [Configuring Enterprise Domains on page 256](#) for more information.

Services

The **Services** window consists of the following tabs:

- **AirGroup**—Allows you to configure the AirGroup and AirGroup services. For more information, see [Configuring AirGroup on page 377](#).
- **RTLS**—Allows you to integrate AMP or third-party RTLS such as Aeroscout RTLS with AOS-W Instant. For more information, see [Configuring an OAW-IAP for RTLS Support on page 386](#).
The RTLS tab also allows you to integrate OAW-IAP with the ALE. For more information about configuring an OAW-IAP for ALE integration, see [Configuring an OAW-IAP for ALE Support on page 388](#).
- **OpenDNS**—Allows you to configure support for OpenDNS business solutions, which require an OpenDNS (www.opendns.com) account. The OpenDNS credentials are used by AOS-W Instant and OmniVista 3600 Air Manager to filter content at the enterprise level. For more information, see [Configuring OpenDNS Credentials on page 393](#).

- **CALEA**—Allows you configure support for CALEA server integration, thereby ensuring compliance with Lawful Intercept and CALEA specifications. For more information, see [CALEA Integration and Lawful Intercept Compliance on page 399](#).
- **Network Integration**—Allows you to configure an OAW-IAP for integration with Palo Alto Networks Firewall and XML API server. For more information on OAW-IAP integration with PAN, see [Integrating an OAW-IAP with Palo Alto Networks Firewall on page 393](#) and [Integrating an OAW-IAP with an XML API Interface on page 395](#).
- **Dynamic DNS**—Allows you to configure dynamic DNS on Distributed L3 clients. For more information on Dynamic DNS, see [Dynamic DNS Registration on page 307](#).
- **Clarity**—Allows you to configure Clarity Live for generating inline monitoring statistics. For more information, see [Clarity Live on page 391](#).
- **Openflow**—Allows you to configure OpenFlow services on the OAW-IAP. For more information, see [SDN on page 1](#).
- **IoT**—Allows you to configure IoT endpoints on the OAW-IAP. For more information, see [BLE IoT for Data Communication on page 403](#).

DHCP Server

The **DHCP Servers** window allows you to configure various DHCP modes. For more information, see [DHCP Configuration on page 276](#).

Maintenance

The **Maintenance** tab displays a window that allows you to maintain the Wi-Fi network. The **Maintenance** tab consists of the following sections:

- **About**—Displays the name of the product, build time, OAW-IAP model name, the AOS-W Instant version, website address of Alcatel-Lucent, copyright information, and the cloud activation key.
- **Firmware**—Displays the current firmware version and provides various options to upgrade to a new firmware version. For more information, refer to the *Alcatel-Lucent AOS-W Instant Release Notes*.
- **Configuration**—Displays the following details:
 - **Current Configuration**—Displays the current configuration details.
 - **Clear Configuration**—Allows you to clear the current configuration details of the network. Select the **Remove all configurations including per-AP settings and certificates** checkbox to remove the per-AP settings and certificates as well.

The **Remove all configurations including per-AP settings and certificates** option is applicable only to clear configurations. It is not applicable to backup and restore configurations.

- **Backup Configuration**—Allows you to back up local configuration details. The backed up configuration data is saved in the file named **instant.cfg**.
- **Restore Configuration**—Allows you to restore the backed up configuration. After restoring the configuration, the OAW-IAP must be rebooted for the changes to take effect.
- **Certificates**—Displays information about the certificates installed on the OAW-IAP. You can also upload new certificates to the OAW-IAP database. For more information, see [Uploading Certificates on page 235](#).
- **Reboot**—Displays the OAW-IAPs in the network and provides an option to reboot the required OAW-IAP or all OAW-IAPs. For more information, refer to the *Alcatel-Lucent AOS-W Instant Release Notes*.
- **Convert**—Provides an option to convert an OAW-IAP to a OmniAccess Mobility Controller managed OAW-RAP or OAW-AP, or to the default virtual switch mode. For more information, see [Converting an OAW-IAP to a OAW-RAP and OAW-AP on page 465](#).
- **DRT**—Displays the DRT version running in an OAW-IAP. The DRT window contains the following sections:

- **Manual**—Displays the current DRT version of the OAW-IAP. You can manually upgrade the DRT version by uploading a DRT file or by entering the URL.
- **Reset**—Resets the DRT version.
- **Automatic**—Enables an automatic DRT version upgrade.

Support

The **Support** tab consists of the following details:

- **Command**—Allows you to select a support command for execution.
- **Target**—Displays a list of OAW-IAPs in the network.
- **Run**—Allows you to execute the selected command for a specific OAW-IAP or all OAW-IAPs and view logs.
- **Auto Run**—Allows you to configure a schedule for automatic execution of a support command for a specific OAW-IAP or all OAW-IAPs.
- **Filter**—Allows you to filter the contents of a command output.
- **Clear**—Clears the command output that is displayed after a command is executed.
- **Save**—Allows you to save the support command logs as an HTML or text file.

For more information on support commands, see [Running Debug Commands on page 481](#).

This chapter consists of the following sections:

- [Configuring System Parameters on page 63](#)
- [Changing Password on page 71](#)

Configuring System Parameters

This section describes how to configure the system parameters of an OAW-IAP.

In the Old WebUI

1. Navigate to **System > General**.

Table 18: *System Parameters*

Parameter	Description	CLI Configuration
Name	Name of the OAW-IAP.	<ul style="list-style-type: none"> ■ (Instant AP) # name <name>
System location	Physical location of the OAW-IAP.	<ul style="list-style-type: none"> ■ (Instant AP) # (config) # syslocation <location-name>
Virtual Controller IP	This parameter allows you to specify a single static IP address that can be used to manage a multi-OAW-IAPAOS-W Instant network. This IP address is automatically provisioned on a shadow interface on the OAW-IAP that takes the role of a virtual switch. When an OAW-IAP becomes a virtual switch, it sends three ARP messages with the static IP address and its MAC address to update the network ARP cache.	<ul style="list-style-type: none"> ■ (Instant AP) (config) # virtual-controller-ip <IP-address>
Allow IPv6 Management	Select the check box to enable IPv6 configuration	
Virtual Controller IPv6	This parameter is used to configure the IPv6 address.	<ul style="list-style-type: none"> ■ (Instant AP) (config) # virtual-controller-ipv6 <ipv6 address>
Uplink switch native VLAN	This parameter notifies the OAW-IAP about the native-VLAN of the upstream switch to which the OAW-IAP is connected. The parameter stops the OAW-IAP from sending out tagged frames to clients connected with the SSID that has the same VLAN as the native VLAN of the upstream switch, to which the OAW-IAP is connected. By default, the OAW-IAP considers the uplink switch native VLAN value as 1.	<ul style="list-style-type: none"> ■ (Instant AP) (config) # enet-vlan <vlan-ID>
Dynamic Proxy	This parameter allows you to enable or disable the dynamic proxy for RADIUS and TACACS servers.	To enable dynamic RADIUS proxy:

Table 18: System Parameters

Parameter	Description	CLI Configuration
	<ul style="list-style-type: none"> ■ Dynamic RADIUS Proxy—When dynamic RADIUS proxy is enabled, the virtual switch network will use the IP address of the virtual switch for communication with external RADIUS servers. Ensure that you set the virtual switch IP address as a NAS client in the RADIUS server if Dynamic RADIUS proxy is enabled. ■ Dynamic TACACS Proxy—When enabled, the virtual switch network will use the IP address of the virtual switch for communication with external TACACS servers. The IP address is chosen based on one of the following rules: <ul style="list-style-type: none"> ● If a VPN tunnel exists between the OAW-IAP and the TACACS server, then the IP address of the tunnel interface will be used. ● If a virtual switch IP address is configured, the the same will be used by the virtual switch network to communicate with the external TACACS server. ● If a virtual switch IP is not configured, then the IP address of the bridge interface is used. <p>NOTE: When dynamic-tacacs-proxy is enabled on the OAW-IAP, the TACACS server cannot identify the slave OAW-IAP that generates the TACACS traffic as the source IP address is changed.</p>	<ul style="list-style-type: none"> ■ (Instant AP) (config)# dynamic-radius-proxy <p>To enable TACACS proxy:</p> <ul style="list-style-type: none"> ■ (Instant AP) (config)# dynamic-tacacs-proxy
<p>NTP Server</p>	<p>This parameter allows you to configure NTP server. To facilitate communication between various elements in a network, time synchronization between the elements and across the network is critical. Time synchronization allows you to:</p> <ul style="list-style-type: none"> ■ Trace and track security gaps, monitor network usage, and troubleshoot network issues. ■ Validate certificates. ■ Map an event on one network element to a corresponding event on another. ■ Maintain accurate time for billing services and similar tasks. <p>NTP helps obtain the precise time from a server and regulate the local time in each network element. Connectivity to a valid NTP server is required to synchronize the OAW-IAP clock to set the correct time. If NTP server is not configured in the OAW-IAP network, an OAW-IAP reboot may lead to variation in time data.</p>	<p>To configure an NTP server:</p> <ul style="list-style-type: none"> ■ (Instant AP) (config)# ntp-server <name>

Table 18: System Parameters

Parameter	Description	CLI Configuration
	<p>By default, the OAW-IAP tries to connect to pool.ntp.org to synchronize time. The NTP server can also be provisioned through the DHCP option 42. If the NTP server is configured, it takes precedence over the DHCP option 42 provisioned value. The NTP server provisioned through the DHCP option 42 is used if no server is configured. The default server pool.ntp.org is used if no NTP server is configured or provisioned through DHCP option 42.</p> <p>NOTE: To facilitate ZTP using the AMP or Activate, you must configure the firewall and wired infrastructure to either allow the NTP traffic to pool.ntp.org, or provide alternative NTP servers under DHCP options.</p>	
Timezone	<p>Timezone in which the OAW-IAP must operate. You can also enable DST on OAW-IAPs if the time zone you selected supports the DST. When enabled, the DST ensures that the OAW-IAPs reflect the seasonal time changes in the region they serve.</p>	<p>To configure timezone:</p> <ul style="list-style-type: none"> ■ (Instant AP) (config)# clock timezone <name> <hour- offset> <minute- offset> <p>To configure DST:</p> <ul style="list-style-type: none"> ■ (Instant AP) (config)# clock summer-time <timezone> recurring ■ <start-week> <start- day> <start-month> ■ <start-hour> <end- week> <end-day> <end- month> <end-hour>
Preferred Band	<p>The preferred band for the OAW-IAP.</p> <p>NOTE: Reboot the OAW-IAP after modifying the radio profile for changes to take effect.</p>	<ul style="list-style-type: none"> ■ (Instant AP) (config)# rf-band <band>
AppRF Visibility	<p>Select one of the following options from the AppRF visibility drop-down list.</p> <ul style="list-style-type: none"> ■ App—Displays only inbuilt DPI data. ■ WebCC—Displays the DPI data hosted on the cloud. ■ All—Displays both App and WebCC DPI data. ■ None—Does not display any AppRF content. 	<ul style="list-style-type: none"> ■ (Instant AP) (config)# dpi
URL Visibility	<p>Select Enabled or Disabled from the URL visibility drop-down list.</p>	<ul style="list-style-type: none"> ■ (Instant AP) (config)# url- visibility
Cluster security	<p>Select Enabled to ensure that the control plane messages between access points are secured. This option is disabled by default.</p> <p>NOTE: The Cluster security setting can be enabled only if the default NTP server or a static NTP server is reachable.</p>	<ul style="list-style-type: none"> ■ (Instant AP) (config)# cluster- security

Table 18: System Parameters

Parameter	Description	CLI Configuration
Low assurance PKI	Select Allow or Deny from the drop-down list. You can enable the this parameter only if DTLS is allowed.	<ul style="list-style-type: none"> ■ (Instant AP) (config)# cluster-security ■ (Instant AP) (cluster-security)# allow-low-assurance-devices
Non-DTLS Slaves	When DTLS is supported on low assurance OAW-IAPs, users have an option to prevent non-TPM OAW-IAPs from establishing a DTLS connection with regular OAW-IAPs. A new alert is displayed on the WebUI to warn the users when a DTLS connection with a non-TPM OAW-IAP is denied. The alert also displays the IP address of the OAW-IAP. For more security, specific OAW-IAPs are allowed to form a cluster.	<ul style="list-style-type: none"> ■ (Instant AP) (config)# cluster-security ■ (Instant AP) (cluster-security)# dtls
Virtual Controller network settings	<p>If the virtual switch IP address is in a different subnet than that of the OAW-IAP, ensure that you select Custom from the Virtual Controller network settings drop-down list and configure the following details:</p> <ul style="list-style-type: none"> ■ Virtual Controller Netmask—Enter subnet mask details. ■ Virtual Controller Gateway—Enter a gateway address. ■ Virtual Controller DNS—If the DNS IP address is configured for a master OAW-IAP, the DNS IP settings are synchronized for all APs in anOAW-IAP cluster. <ul style="list-style-type: none"> ● If the DNS IP address is configured for anOAW-IAP as part of the per OAW-IAP setting (Edit Access Point > General), it takes precedence over the virtual switch DNS IP address defined in the System > General window. ● If the OAW-IAPs are not explicitly assigned a DNS IP address, the DNS IP address defined in System > General takes precedence. <p>If the DNS IP address is not defined for OAW-IAPs or virtual switch, the DNS address dynamically assigned from the DHCP server is used.</p> <ul style="list-style-type: none"> ■ Virtual Controller VLAN—Ensure that the VLAN defined for the virtual switch is not the same as the native VLAN of the OAW-IAP. <p>virtual switch VLAN, gateway, and subnet mask details.</p>	<ul style="list-style-type: none"> ■ (Instant AP) (config)# virtual-controller-dnsip <addr> ■ (Instant AP) (config)# virtual-controller-vlan <vcvlan> <vcmask> <vcgw>

Table 18: System Parameters

Parameter	Description	CLI Configuration
Auto join mode	The Auto-Join feature allows OAW-IAPs to automatically discover the virtual switch and join the network. The Auto-Join feature is enabled by default. If the Auto-Join feature is disabled, a link is displayed in the Access Points tab indicating that there are new OAW-IAPs discovered in the network. Click this link if you want to add these OAW-IAPs to the network. When Auto-Join feature is disabled, the inactive OAW-IAPs are displayed in red.	To disable auto-join mode: <ul style="list-style-type: none"> ■ (Instant AP) (config)# no allow-new-aps To enable auto-join mode: <ul style="list-style-type: none"> ■ (Instant AP) (config)# allow-new-aps
Terminal access	When terminal access is enabled, you can access the OAW-IAP CLI through SSH. The terminal access is enabled by default	<ul style="list-style-type: none"> ■ (Instant AP) (config)# terminal-access
Console access	When enabled, you can access the OAW-IAP through the console port.	<ul style="list-style-type: none"> ■ (Instant AP) (config)# console
Telnet server	To start a Telnet session with the OAW-IAP CLI, enable access to the Telnet server.	<ul style="list-style-type: none"> ■ (Instant AP) (config)# telnet-server
LED display	LED display status of the OAW-IAP. To enable or disable LED display for all OAW-IAPs in a cluster, select Enabled or Disabled , respectively. NOTE: The LEDs are always enabled during the OAW-IAP reboot.	<ul style="list-style-type: none"> ■ (Instant AP) (config)# led-off
Extended SSID	Extended SSID is enabled by default in the factory default settings of OAW-IAPs. This disables mesh in the factory default settings. OAW-IAPs support up to 14 SSIDs when Extended SSID is disabled and up to 16 SSIDs with Extended SSID enabled. If more than 16 SSIDs are assigned to a zone, you will receive an error message when you disable extended zone.	<ul style="list-style-type: none"> ■ (Instant AP) (config)# extended-ssid

Table 18: System Parameters

Parameter	Description	CLI Configuration
<p>Deny inter user bridging</p>	<p>If you have security and traffic management policies defined in upstream devices, you can disable bridging traffic between two clients connected to the same OAW-IAP on the same VLAN. When inter user bridging is denied, the clients can connect to the Internet but cannot communicate with each other, and the bridging traffic between the clients is sent to the upstream device to make the forwarding decision. This global parameter overwrites all the options available in an SSID profile. For example, when this parameter is enabled, all the SSIDs deny client-to-client bridging traffic.</p> <p>By default, the Deny inter user bridging parameter is disabled.</p>	<ul style="list-style-type: none"> ■ (Instant AP) (config)# deny-inter-user-bridging <p>To disable inter-user bridging for the WLAN SSID clients:</p> <ul style="list-style-type: none"> ■ (Instant AP) (config)# wlan ssid-profile <ssid-profile> ■ (Instant AP) (SSID Profile <ssid-profile>)# deny-inter-user-bridging
<p>Deny local routing</p>	<p>If you have security and traffic management policies defined in upstream devices, you can disable routing traffic between two clients connected to the same OAW-IAP on different VLANs. When local routing is disabled, the clients can connect to the Internet but cannot communicate with each other, and the routing traffic between the clients is sent to the upstream device to make the forwarding decision. This global parameter overwrites all the options in an SSID profile. For example, when this parameter is enabled, all the SSIDs deny client-to-client local traffic.</p> <p>By default, the Deny local routing parameter is disabled.</p>	<ul style="list-style-type: none"> ■ (Instant AP) (config)# deny-local-routing
<p>Dynamic CPU Utilization</p>	<p>OAW-IAPs perform various functions such as wired and wireless client connectivity and traffic flows, wireless security, network management, and location tracking. If an OAW-IAP is overloaded, it prioritizes the platform resources across different functions. Typically, the OAW-IAPs manage resources automatically in real time. However, under special circumstances, if dynamic resource management needs to be enforced or disabled altogether, the dynamic CPU management feature settings can be modified.</p> <p>To configure dynamic CPU management, select any of the following options from DYNAMIC CPU UTILIZATION.</p> <ul style="list-style-type: none"> ■ Automatic—When selected, the CPU management is enabled or disabled automatically during runtime. This decision is based on real-time load calculations taking into account all different functions that the CPU needs to perform. This is the default and recommended option. ■ Always Disabled in all APs—When selected, this setting disables CPU management on all OAW-IAPs, typically for small networks. This setting protects user experience. 	<ul style="list-style-type: none"> ■ (Instant AP) (config)# dynamic-cpu-mgmt

Table 18: System Parameters

Parameter	Description	CLI Configuration
	<ul style="list-style-type: none"> ■ Always Enabled in all APs—When selected, the client and network management functions are protected. This setting helps in large networks with high client density. 	

Configuring System Parameters

This section describes how to configure the system parameters of an OAW-IAP.

In the New WebUI

1. Navigate to **Configuration > System > General**.

Table 19: System Parameters

Parameter	Description	CLI Configuration
Name	Name of the OAW-IAP.	<ul style="list-style-type: none"> ■ (Instant AP) # name <name>
System location	Physical location of the OAW-IAP.	<ul style="list-style-type: none"> ■ (Instant AP) # (config) # syslocation <location-name>
Virtual Controller IP	This parameter allows you to specify a single static IP address that can be used to manage a multi-OAW-IAPAOS-W Instant network. This IP address is automatically provisioned on a shadow interface on the OAW-IAP that takes the role of a virtual switch. When an OAW-IAP becomes a virtual switch, it sends three ARP messages with the static IP address and its MAC address to update the network ARP cache.	<ul style="list-style-type: none"> ■ (Instant AP) (config) # virtual-controller-ip <IP-address>
Allow IPv6 Management	Click the toggle switch to enable IPv6 configuration	
Virtual Controller IPv6	This parameter is used to configure the IPv6 address.	<ul style="list-style-type: none"> ■ (Instant AP) (config) # virtual-controller-ipv6 <ipv6 address>
Dynamic RADIUS Proxy	When dynamic RADIUS proxy is enabled, the virtual switch network will use the IP address of the virtual switch for communication with external RADIUS servers. Ensure that you set the virtual switch IP address as a NAS client in the RADIUS server if Dynamic RADIUS proxy is enabled.	<ul style="list-style-type: none"> ■ (Instant AP) (config) # dynamic-radius-proxy
Dynamic TACACS Proxy	When enabled, the virtual switch network will use the IP address of the virtual switch for communication with external TACACS servers. The IP address is chosen based on one of the following rules: <ul style="list-style-type: none"> ● If a VPN tunnel exists between the OAW-IAP and the TACACS server, then the IP address of the tunnel interface will be used. ● If a virtual switch IP address is configured, the the same will be used by the virtual switch network to communicate with the external TACACS server. 	<ul style="list-style-type: none"> ■ (Instant AP) (config) # dynamic-tacacs-proxy

Table 19: System Parameters

Parameter	Description	CLI Configuration
	<ul style="list-style-type: none"> ● If a virtual switch IP is not configured, then the IP address of the bridge interface is used. <p>NOTE: When dynamic-tacacs-proxy is enabled on the OAW-IAP, the TACACS server cannot identify the slave OAW-IAP that generates the TACACS traffic as the source IP address is changed.</p>	
NTP Server	<p>This parameter allows you to configure NTP server. To facilitate communication between various elements in a network, time synchronization between the elements and across the network is critical. Time synchronization allows you to:</p> <ul style="list-style-type: none"> ■ Trace and track security gaps, monitor network usage, and troubleshoot network issues. ■ Validate certificates. ■ Map an event on one network element to a corresponding event on another. ■ Maintain accurate time for billing services and similar tasks. <p>NTP helps obtain the precise time from a server and regulate the local time in each network element. Connectivity to a valid NTP server is required to synchronize the OAW-IAP clock to set the correct time. If NTP server is not configured in the OAW-IAP network, an OAW-IAP reboot may lead to variation in time data. By default, the OAW-IAP tries to connect to pool.ntp.org to synchronize time. The NTP server can also be provisioned through the DHCP option 42. If the NTP server is configured, it takes precedence over the DHCP option 42 provisioned value. The NTP server provisioned through the DHCP option 42 is used if no server is configured. The default server pool.ntp.org is used if no NTP server is configured or provisioned through DHCP option 42.</p> <p>NOTE: To facilitate ZTP using the AMP or Activate, you must configure the firewall and wired infrastructure to either allow the NTP traffic to pool.ntp.org, or provide alternative NTP servers under DHCP options.</p>	<p>To configure an NTP server:</p> <ul style="list-style-type: none"> ■ (Instant AP) (config) # ntp-server <name>
Timezone	<p>Timezone in which the OAW-IAP must operate. You can also enable DST on OAW-IAPs if the time zone you selected supports the DST. When enabled, the DST ensures that the OAW-IAPs reflect the seasonal time changes in the region they serve.</p>	<p>To configure timezone:</p> <ul style="list-style-type: none"> ■ (Instant AP) (config) # clock timezone <name> <hour-offset> <minute-offset> <p>To configure DST:</p> <ul style="list-style-type: none"> ■ (Instant AP) (config) # clock summer-time <timezone> recurring ■ <start-week> <start-day> <start-month> ■ <start-hour> <end-week> <end-day> <end-month> <end-hour>
Preferred Band	<p>The preferred band for the OAW-IAP.</p> <p>NOTE: Reboot the OAW-IAP after modifying the radio profile for changes to take effect.</p>	<ul style="list-style-type: none"> ■ (Instant AP) (config) # rf-band <band>

Table 19: System Parameters

Parameter	Description	CLI Configuration
AppRF Visibility	Select one of the following options from the AppRF visibility drop-down list. <ul style="list-style-type: none"> ■ App—Displays only inbuilt DPI data. ■ WebCC—Displays the DPI data hosted on the cloud. ■ All—Displays both App and WebCC DPI data. ■ None—Does not display any AppRF content. 	<ul style="list-style-type: none"> ■ (Instant AP) (config) # dpi
URL Visibility	Click the toggle switch to enable URL visibility.	<ul style="list-style-type: none"> ■ (Instant AP) (config) # url-visibility
Cluster security	Select Enabled to ensure that the control plane messages between access points are secured. This option is disabled by default. NOTE: The Cluster security setting can be enabled only if the default NTP server or a static NTP server is reachable.	<ul style="list-style-type: none"> ■ (Instant AP) (config) # cluster-security

Changing Password

You can update your password details by using the WebUI or the CLI.

In the Old WebUI

To change the admin user password:

1. Navigate to **System > Admin**.
2. Under **Local**, provide a new password that you would like the admin users to use.
3. Click **OK**.

In the New WebUI

To change the admin user password:

1. Navigate to **Configuration > System > Admin**.
2. Under **Local**, provide a new password that you would like the admin users to use.
3. Click **Save**.

In the CLI

To change the admin user password:

```
(Instant AP) (config) # mgmt-user <username> [password]
```

Hashing of Management User Password

Starting from AOS-W Instant 6.5.0.0-4.3.0.0, all the management user passwords can be stored and displayed as hash instead of plain text. Hashed passwords are more secure as they cannot be converted back to plain text format.

Upgrading to the AOS-W Instant 6.5.0.0-4.3.0.0 version will not automatically enable hashing of management user passwords, as this setting is optional. Users can choose if management passwords need to be stored and displayed as hash, or if the passwords need to remain in encrypted format.

This setting is enabled by default on factory reset OAW-IAPs running AOS-W Instant 6.5.0.0-4.3.0.0 onwards, and is applicable to all OAW-IAPs in the cluster.

Hashing of the management user password can be configured by using either the WebUI or the CLI.

In the Old WebUI

To set the management password in hash format:

1. Navigate to **System > Admin**.
2. Click the **show advanced options** link.
3. Select the **Hash Management Password** check box. This will enable the hashing of the management user password.

In the New WebUI

To set the management password in hash format:

1. Navigate to **Configuration > System > Admin**.
2. Click the **show advanced options** link.
3. Select the **Hash Management Password** check box. This will enable the hashing of the management user password.



The check box will appear grayed out after this setting is enabled, as this setting cannot be reversed.

In the CLI

The following example enables the hashing of a management user password:

```
(Instant AP) (config)# hash-mgmt-password
```

The following example adds a management user with read-only privilege:

```
(Instant AP) (config)# hash-mgmt-user john password cleartext password01 usertype read-only
```

The following examples removes a management user with read-only privilege:

```
(Instant AP) (config)# no hash-mgmt-user read-only
```

This chapter describes the procedures for configuring settings that are specific to an OAW-IAP in the cluster.

- [Discovery Logic on page 73](#)
- [Modifying the OAW-IAP Host Name on page 78](#)
- [Configuring Zone Settings on an OAW-IAP on page 78](#)
- [Specifying a Method for Obtaining IP Address on page 79](#)
- [Configuring External Antenna on page 80](#)
- [Configuring Radio Profiles for an OAW-IAP on page 82](#)
- [Enabling Flexible Radio on page 85](#)
- [Configuring Uplink VLAN for an OAW-IAP on page 86](#)
- [Changing the OAW-IAP Installation Mode on page 87](#)
- [Changing USB Port Status on page 88](#)
- [Master Election and Virtual switch on page 88](#)
- [Adding an OAW-IAP to the Network on page 90](#)
- [Removing an OAW-IAP from the Network on page 91](#)
- [Support for BLE Asset Tracking on page 91](#)
- [IPM on page 93](#)
- [Transmit Power Calculation Support on 200 Series and 300 Series Access Points on page 94](#)

Discovery Logic

In the previous AOS-W Instant releases, access points were predefined as either switch-based OAW-APs or switch-less AOS-W Instant APs. Each legacy OAW-IAP was shipped with an AOS-W Instant image that enabled the OAW-IAP to act as its own virtual switch or to join an existing AOS-W Instant cluster.

Starting with AOS-W Instant 6.5.2.0, the new access points introduced in this release or following releases can run on both switch-based mode and switch-less mode. Based on the selected mode, the AP runs a corresponding image:

- switch mode will run AOS-W image.
- switch-less mode will run AOS-W Instant image.

Each access point is shipped with either a limited functionality manufacturing image or an AOS-W Instant image. An access point with either of the limited functionality manufacturing image or the AOS-W Instant image will run the full discovery logic. Based on that, it will download the AOS-W or AOS-W Instant image and convert to the corresponding mode.

By default, switch discovery has a higher priority than Instant discovery. If the AP cannot locate any switches during the switch discovery process, it enters AOS-W Instant discovery. For more information on switch discovery, refer to the *AP Discovery Logic* section in the AOS-W User Guide.

The Cloud First principle is applied to the AP discovery feature. In this principle, the AP, regardless of whether it is factory reset or configured, retrieves provisioning rules from Activate after it boots up.

Preference Role

Users can predefine the AP mode by configuring the preference role. APs with the default preference role follow the standard discovery logic by attempting switch discovery before initiating AOS-W Instant discovery. APs with the switch-less preference role can bypass switch discovery and immediately initiate AOS-W Instant discovery.

In the AOS-W WebUI

To set the AP preference role to switch-less in the WebUI:

1. Navigate to **Maintenance > Access Point > Convert to instant mode** in the WebUI.
2. Select the AP(s) on which you want to set the preference role to switch-less.
3. Click **Convert to instant mode**.

In the CLI

To set the AP preference role to switch-less in the CLI, execute the following commands:

```
(host) #ap redeploy controller-less
all
ap-group
ap-name
ip-addr
ip6-addr
wired-mac
```

Discovery Logic Workflow

The following steps describe the AP discovery logic:

Figure 3 AP Discovery Logic

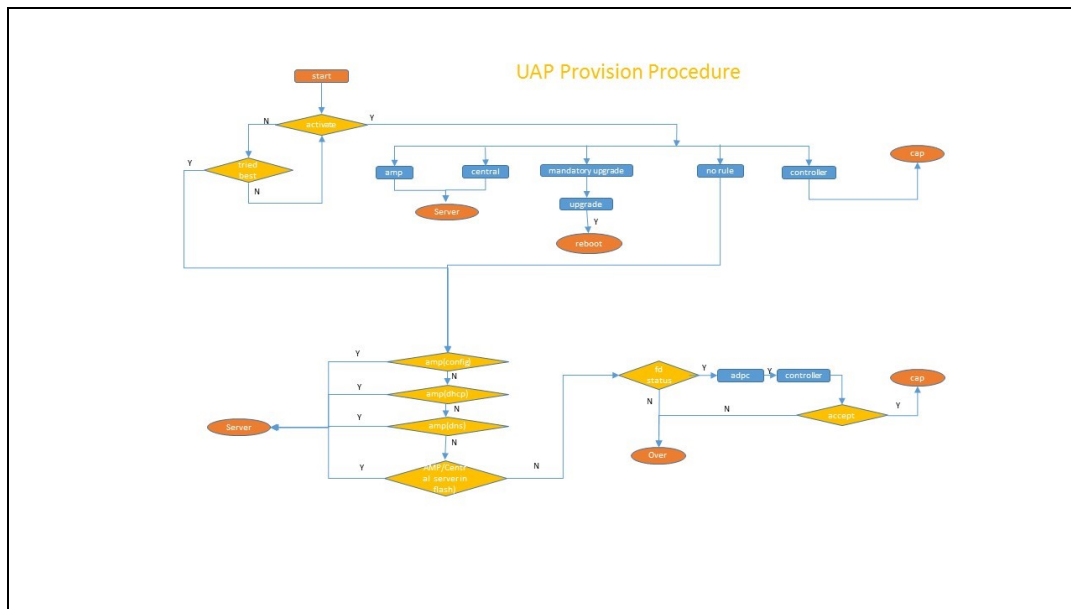

1. When an AP boots up, it connects to Activate to obtain a provisioning rule.
2. If provisioning is already done by OmniVista 3600 Air Manager, verify if a provisioning rule exists. If yes, the provisioning rule is saved in the flash memory. Compare the saved provisioning rule with the rule in Activate. If the rule in Activate is new, save the new provisioning rule in flash. For example, if the master and slave OAW-IAPs obtain different OmniVista 3600 Air Manager addresses or if the master and slave OAW-IAPs obtain a different OmniVista 3600 Air Manager rule, the master OAW-IAP rule takes higher precedence.



Only the master OAW-IAP can apply provisioning rules to the OAW-IAP cluster.

3. If the rule is to perform a mandatory upgrade of the OAW-IAP, ensure to upgrade the OAW-IAP to the desired version. The master OAW-IAP executes the upgrade after a cluster is formed.
4. If the rule is to convert the OAW-IAP to Campus AP or Remote AP, the conversion takes effect for every OAW-IAP regardless of whether it is a master or a slave. This requires a manual registration of every master and slave OAW-IAP with Activate.
5. If there is no rule from Activate or if conversion to Campus AP or Remote AP fails, the master AP conducts local provisioning detection to check the local OmniVista 3600 Air Manager configuration.
 - If the OmniVista 3600 Air Manager server is configured and is in the configuration file, apply the server details. Otherwise, conduct a DHCP based OmniVista 3600 Air Manager or Central??? detection.
 - If DHCP-based OmniVista 3600 Air Manager is not found and the OAW-IAP is in factory default status, perform a DNS based AirWave discovery.
 - If none of the above methods can detect the OmniVista 3600 Air Manager server and if the OAW-IAP cannot connect to Activate, use the provisioning rule in flash.
6. If the OmniVista 3600 Air Manager or Central??? server is not found, or if the OAW-IAP is a slave, verify if the following conditions for local switch discovery are met:
 - The OAW-IAP is factory reset.
 - The **uap_controller_less** mode is not set.
 - There is no provision rule saved in flash.
7. If the switch is found, the OAW-IAP sends a hello message to the switch and converts to a Campus AP.
8. When a master failover happens, the new master OAW-IAP connects to Activate to retrieve the provisioning rule. If the new master successfully obtains the provisioning rule, it applies this rule to the cluster.

Manual Upgrade

APs running in unprovisioned mode broadcast a special provisioning SSID to which users can connect to upgrade the AP manually. Upon connecting, users can access a local provisioning page in the WebUI to upgrade the AP to an AOS-W or AOS-W Instant image. For more information on upgrading APs manually, refer to the following scenarios:

- switch-based AP over Manual OAW-AP or OAW-RAP Conversion in the *AOS-W User Guide*.
- switch-less AP over Manual OAW-IAP Conversion in the *AOS-W User Guide*.



The provisioning SSID for all APs running AOS-W Instant 6.5.2.0 onwards, including legacy OAW-IAPs is **SetMeUp-xx:xx:xx**.

Deployment Scenarios

This section describes the switch-less AP deployment and hybrid deployment scenarios:

switch-less AP Deployments

The following sections describe switch-less AP deployment scenarios.

switch-less AP in an AOS-W Instant Network

Users can deploy APs directly into a running AOS-W Instant network, which consists of an OAW-IAP cluster and a virtual switch that manages the network. A virtual switch must be available before any AP can be upgraded

through this deployment scenario. For more information on electing a master in an AOS-W Instant network, see [Master Election and Virtual switch on page 88](#).

APs are upgraded to the AOS-W Instant image through a virtual switch as explained in the following steps:

1. The AP boots up in unprovisioned mode with either the limited functionality manufacturing image or the AOS-W Instant image from the factory.
2. The AP enters the switch discovery process using static, DHCP, ADP, or DNS based switch discovery.



If the preference role is set to switch-less, the AP bypasses switch discovery and immediately enters AOS-W Instant discovery (skip to Step 3)

3. If the AP cannot locate any switch, it enters the Instant discovery process to locate an AOS-W Instant virtual switch, Activate, OmniVista 3600 Air Manager.
4. The AP attempts to discover a virtual switch in an existing OAW-IAP cluster.
5. If a virtual switch is discovered, the AP joins the existing OAW-IAP cluster and downloads the AOS-W Instant image from the cluster.
6. After the image is downloaded, the AP reboots.
7. The configuration syncs, and the AP runs in switch-less mode.

switch-less AP over Activate or OmniVista 3600 Air Manager

If the AP cannot locate a virtual switch in an existing OAW-IAP cluster, the AP attempts to connect to Activate or OmniVista 3600 Air Manager to upgrade the AP to the AOS-W Instant image and form a new OAW-IAP cluster.



In this deployment scenario, Activate or OmniVista 3600 Air Manager must be accessible to the AP.

APs are upgraded to the AOS-W Instant image through Activate or OmniVista 3600 Air Manager as explained in the following steps:

1. The AP boots up in unprovisioned mode with either the limited functionality manufacturing image or the AOS-W Instant image from the factory.
2. The AP enters the switch discovery process using static, DHCP, ADP, or DNS based switch discovery.



If the preference role is set to switch-less, the AP bypasses switch discovery and immediately enters AOS-W Instant discovery (skip to Step 3)

3. If the AP cannot locate any switch, it enters the AOS-W Instant discovery process to locate an AOS-W Instant virtual switch, Activate or OmniVista 3600 Air Manager.
4. The AP attempts to discover a virtual switch in an existing OAW-IAP cluster.
5. If the AP cannot locate a virtual switch in an existing OAW-IAP cluster, the AP attempts to locate Activate or OmniVista 3600 Air Manager to upgrade the image and form a new OAW-IAP cluster.



APs running the manufacturing image cannot form an OAW-IAP cluster.

- If the AP locates Activate, it receives pre-configured provisioning rules to connect to OmniVista 3600 Air Manager or convert into a OAW-AP or OAW-RAP.



APs that connect to Activate are automatically upgraded from the manufacturing image to the latest AOS-W Instant or AOS-W Instant image. Refer to the latest *Alcatel-Lucent Activate User Guide* for more details on configuring provisioning rules.

- If the AP locates OmniVista 3600 Air Manager, it can be upgraded to the AOS-W Instant image. If an enforced image upgrade rule is configured in OmniVista 3600 Air Manager, the AP is upgraded to the AOS-W Instant image that is configured for the enforced upgrade rule. If no enforced upgrade rule is configured, the AP is upgraded to the latest AOS-W Instant image in OmniVista 3600 Air Manager. After the AP is upgraded, it reboots in switch-less mode. Refer to the latest *OmniVista 3600 Air Manager User Guide* for details on AP image upgrade.



All firmware must be uploaded to OmniVista 3600 Air Manager before the AP connects and downloads the Instant image. Refer to the latest *OmniVista 3600 Air Manager Deployment Guide* for details on firmware upload.

After the AP is upgraded to switch-less mode, it forms a new OAW-IAP cluster and converts into the master. Other APs which are not deployed can join the cluster and upgrade to the AOS-W Instant image.

switch-less AP over Manual OAW-IAP Conversion.

If the AP cannot be upgraded into an OAW-IAP through a virtual switch, Activate or OmniVista 3600 Air Manager, users can connect to a special provisioning SSID broadcasted by the unprovisioned AP to manually convert the AP to an OAW-IAP through the WebUI. Refer to the *switch-less AP in an AOS-W Instant Network* section and the *switch-less AP over Activate or OmniVista 3600 Air Manager* section in the *AOS-W User Guide* for details on upgrading an AP to the AOS-W Instant image using a virtual switch, Activate or OmniVista 3600 Air Manager.

To manually convert an AP to an OAW-IAP in the WebUI:

1. Log in to your virtual switch.
2. Connect to the following provisioning SSID broadcasted by the unprovisioned AP: **SetMeUp-xx:xx:xx**.
3. Open a web browser and then navigate to the following URL:
<https://setmeup.arubanetworks.com>
4. Under **Access Point Setup**, select **Image File** or **Image URL** to upload the AOS-W Instant image.
 - If you selected **Image File**, click **Browse** to locate and select an AOS-W Instant image file from your local file explorer.
 - If you selected **Image URL**, enter the web address of the AOS-W Instant image under **URL**.
5. Click **Save**.

After the AP is upgraded, it reboots in the switch-less mode.

AP Deployments in Hybrid switch-AOS-W Instant Networks

Users can deploy APs into hybrid networks, which contain both switch-based and switch-less APs. APs in hybrid networks are upgraded to the AOS-W or AOS-W Instant image using the same methods as APs in pure switch or AOS-W Instant networks. However, the following items must be in place before deploying APs in a hybrid network:

- switch-based APs and switch-less APs must run on different subnets (for example, a switch-based AP subnet and a separate switch-less AP subnet).
- Different discovery methods should be used for switch-based APs and switch-less APs, as the switch discovery process and AOS-W Instant OmniVista 3600 Air Manager discovery process share the same DHCP or DNS discovery methods. For example, switch-based APs can use a DHCP server to discover a switch, while switch-less APs can use a DNS server on OmniVista 3600 Air Manager.
- If the same discovery method must be used for both switch-based APs and switch-less APs, it is recommended that you use DHCP-based discovery. DHCP servers can respond to DHCP requests based on the AP's subnet and vendor ID. DNS servers do not have a subnet limit and this can cause the APs that share a DNS server to be upgraded on the wrong AP subnet.

Modifying the OAW-IAP Host Name

You can change the host name of an OAW-IAP through the WebUI or the CLI.

In the Old WebUI

To change the host name:

1. In the **Access Points** tab, select the OAW-IAP you want to rename.
2. Click the **edit** link.
3. Under **General** tab, enter a new name in **Name** field. You can specify a name of up to 32 ASCII characters.
4. Click **OK**.

In the New WebUI

To change the host name:

1. Navigate to **Configuration > Access Points**.
2. Select the OAW-IAP to rename and click **Edit**.
3. Expand **General** and enter the new name in the **Name** field. You can specify a name of up to 32 ASCII characters.
4. Click **Save**.

In the CLI

To change the name:

```
(Instant AP)# hostname <name>
```

Configuring Zone Settings on an OAW-IAP

All OAW-IAPs in a cluster use the same SSID configuration including master and slave OAW-IAPs. However, if you want to assign an SSID to a specific OAW-IAP, you can configure zone settings for an OAW-IAP.

Traditionally, an OAW-IAP belongs to only one zone and only one zone can be configured on an SSID. The APs within a zone only broadcast SSIDs configured for that zone. Starting from Alcatel-Lucent AOS-W Instant 8.3.0.0, a zone supports multiple OAW-IAPs that share a common set of SSIDs and these SSIDs can be shared across multiple zones. This provides the ability to handle multiple zones in large campuses.

In the previous releases, commas were a part of the zone name. Commas configured in Alcatel-Lucent AOS-W Instant 6.5.4.x or prior versions will be used as delimiters when OAW-IAPs are upgraded to Alcatel-Lucent AOS-W Instant 8.3.0.x or later. However, there will be a change in the broadcasted SSIDs. You can change the broadcasted SSIDs by using OmniVista 3600 Air Manager .



You can configure up to six SSID zones per AP, and up to 32 SSID zones per ssid-profile. However, it is strongly recommended not to configure multiple zones in per-AP and per-SSID profiles at the same time.

You can add multiple zones in an SSID using comma to separate the zones. For more information, see the [In the CLI](#) section.

You can add an OAW-IAP zone by using the WebUI or the CLI.



For the SSID to be assigned to an OAW-IAP, the same zone details must be configured on the SSID. For more information on SSID configuration, see [Configuring WLAN Settings for an SSID Profile on page 101](#).

In the Old WebUI

To configure the SSID zone settings:

1. Select the OAW-IAP from the **Access Points** tab to configure, and then click **edit**.
2. Under **General** tab, specify the OAW-IAP zone in the **Zone** field.
3. Click **OK**.

To configure the RF zone settings:

1. Select the OAW-IAP from the **Access Points** tab to configure, and then click **edit**.
2. Under **General** tab, specify the OAW-IAP zone in the **RF Zone** field.
3. Click **OK**.

In the New WebUI

To configure the SSID zone settings:

1. Navigate to the **Configuration > Access Points** page.
2. Select the OAW-IAP from the **Access Points** list and click **Edit**.
3. Expand **General** and specify the OAW-IAP zone in the **Zone** field.
4. Click **Save**.

To configure the RF zone settings:

1. Navigate to the **Configuration > Access Points** page.
2. Select the OAW-IAP from the **Access Points** list and click **Edit**.
3. Expand **General** and specify the OAW-IAP zone in the **RF zone** field.
4. Click **Save**.

In the CLI

To change the SSID zone name:

```
(Instant AP) # zonename <name>
```

To add multiple zones in an SSID:

```
(Instant AP) #Wlan ssid-profile default  
zone <zone> configure the zone names for the ssid profiles
```

Zone: Enter multiple zone name as comma-separated values.

Example:

```
(Instant AP) (SSID Profile "default") # zone zone1,zone2,zone3
```

To change the RF zone name:

```
(Instant AP) # rf-zone <name>
```

Specifying a Method for Obtaining IP Address

You can either specify a static IP address or allow the OAW-IAP to obtain an IP address from the DHCP server. By default, the OAW-IAPs obtain IP address from the DHCP server. You can specify a static IP address for the OAW-IAP by using the WebUI or the CLI.

In the Old WebUI

To configure a static IP address:

1. In the **Access Points** tab, select the OAW-IAP to modify and click the **edit** link.
2. Under **General**, for the **IP address for Access Point** option, select **Specify statically** and enter values for the following:
 - a. **IP address**: Enter a new IP address for the OAW-IAP.
 - b. **Netmask**: Enter the subnet mask of the network.
 - c. **Default gateway**: Enter the IP address of the default gateway.
 - d. **DNS server**: Enter the IP address of the DNS server in the text box.
 - e. **Domain name**: Enter the domain name.
3. Click **OK** and reboot the OAW-IAP.

In the New WebUI

To configure a static IP address:

1. Navigate to the **Configuration > Access Points** page.
2. Select the OAW-IAP from the Access Points list and click **Edit**.
3. Under **General**, for the **IP address for Access Point** option, select **Specify statically** and enter values for the following:
 - a. **IP address**: Enter a new IP address for the OAW-IAP.
 - b. **Netmask**: Enter the subnet mask of the network.
 - c. **Default gateway**: Enter the IP address of the default gateway.
 - d. **DNS server**: Enter the IP address of the DNS server in the text box.
 - e. **Domain name**: Enter the domain name.
4. Click **Save** and reboot the OAW-IAP.

In the CLI

To configure a static IP address:

```
(Instant AP) # ip-address <IP-address> <subnet-mask> <NextHop-IP> <DNS-IP-address> <domain-name>
```



When IAP-VPN is not configured or IPsec tunnel to the switch is down, DNS query from the client that is associated to the master OAW-IAP is taken by DNS proxy function on the master OAW-IAP. So, if the DNS server address for the the master OAW-IAP is set (by dnsip or from DHCP server), the DNS query will be sent to the DNS server by the master OAW-IAP. But if the DNS server address is not set, the DNS query will not be sent by the master OAW-IAP. However, the DNS query from the client that is associated to the slave OAW-IAP is not affected to this behavior.

Configuring External Antenna

If your OAW-IAP has external antenna connectors, you need to configure the transmit power of the system. The configuration must ensure that the system's EIRP is in compliance with the limit specified by the regulatory authority of the country in which the OAW-IAP is deployed. You can also measure or calculate additional attenuation between the device and the antenna before configuring the antenna gain. To know if your OAW-IAP device supports external antenna connectors, refer to the *Alcatel-Lucent AOS-W Instant Installation Guide* that is shipped along with the OAW-IAP device.

EIRP and Antenna Gain

The following formula can be used to calculate the EIRP-limit-related RF power based on selected antennas (antenna gain) and feeder (Coaxial Cable loss):

$$\text{EIRP} = \text{Tx RF Power (dBm)} + \text{GA (dB)} - \text{FL (dB)}$$

The following table describes this formula:

Table 20: *Formula Variable Definitions*

Formula Element	Description
EIRP	Limit specific for each country of deployment.
Tx RF Power	RF power measured at RF connector of the unit.
GA	Antenna gain
FL	Feeder loss

Example

For example, the maximum gain that can be configured on an OAW-IAP with AP-ANT-1F dual-band and omnidirectional antenna is as follows:

Table 21: *Maximum Antenna Gains*

Frequency Band	Gain (dBi)
2.4–2.5 GHz	2.0 dBi
4.9–5.875 GHz	5.0 dBi

For information on antenna gain recommended by the manufacturer, see .

Configuring Antenna Gain

You can configure antenna gain for OAW-IAPs with external connectors by using the WebUI or the CLI.

In the Old WebUI

To configure the antenna gain value:

1. From the **Access Points** tab, select the OAW-IAP to configure, and click **edit**.
2. In the **Edit Access Point** window, select **External Antenna** to configure the antenna gain value. This option is available only for access points that support external antennas,
3. Enter the antenna gain values in dBm for the 2.4 GHz and 5 GHz bands.
4. Click **OK**.

In the New WebUI

To configure the antenna gain value:

1. Navigate to the **Configuration > Access Points** page.
2. Select the OAW-IAP and click **Edit**.

3. In the **Edit Access Point** window, select **External Antenna** to configure the antenna gain value. This option is available only for access points that support external antennas,
4. Enter the antenna gain values in dBm for the 2.4 GHz and 5 GHz bands.
5. Click **Save**.

In the CLI

To configure external antenna for 5 GHz frequency:

```
(Instant AP) # a-external-antenna <dBi>
```

To configure external antenna for 2.4 GHz frequency:

```
(Instant AP) # g-external-antenna <dBi>
```

Configuring Radio Profiles for an OAW-IAP

You can configure a radio profile on an OAW-IAP either manually or by using the ARM feature.

ARM is enabled on AOS-W Instant by default. It automatically assigns appropriate channel and power settings for the OAW-IAPs. For more information on ARM, see [Adaptive Radio Management on page 344](#).

In the Old WebUI

To configure ARM-Assigned radio profiles for an OAW-IAP:

1. In the **Access Points** tab, select the OAW-IAP to modify and click **edit**.
2. Select the **Radio** tab.
3. In the **Mode** drop down list box of the desired band, select **Access**.
4. Select the **Automatic channel and transmit power (ARM)** radio button.
5. Click **OK**.

To configure radio profiles manually for OAW-IAP:

1. In the **Access Points** tab, select the OAW-IAP to modify and click **edit**.
2. Select the **Radio** tab.
3. Select a desired radio mode for the respective bands from their **Mode** drop-down list box. The following table describes various configuration modes for an OAW-IAP:



By default, the channel and power for an OAW-IAP are optimized dynamically using ARM. You can override ARM on the 2.4 GHz and 5 GHz bands and set the channel and power manually if desired.

Table 22: OAW-IAP Radio Modes

Mode	Description
Access	<p>In Access mode, the OAW-IAP serves clients, while also monitoring for rogue OAW-IAPs in the background.</p> <p>If the Access mode is selected, perform the following actions:</p> <ol style="list-style-type: none"> 1. Select Administrator assigned in 2.4 GHz and 5 GHz band sections. 2. Select appropriate channel number from the Channel drop-down list for both 2.4 GHz and 5 GHz band sections. 3. Enter appropriate transmit power value in the Transmit power text box in 2.4 GHz and 5 GHz band sections. <p>NOTE: If the transmit power is set to 0, the OAW-IAP is assigned the last transmitted power value set by the ARM.</p>
Monitor	<p>In Monitor mode, the OAW-IAP acts as a dedicated monitor, scanning all channels for rogue OAW-IAPs and clients. You can set one radio on the Monitor mode and the other radio on the access mode, so that the clients can use one radio when the other one is in the Air Monitor mode.</p>
Spectrum Monitor	<p>In Spectrum Monitor mode, the OAW-IAP functions as a dedicated full-spectrum RF monitor, scanning all channels to detect interference, whether from the neighboring OAW-IAPs or from non-WiFi devices such as microwaves and cordless phones.</p> <p>NOTE: In this mode, OAW-IAPs do not provide access services to clients.</p>
 NOTE	<hr/> <p>When radio settings are assigned manually by the administrator, the ARM is disabled.</p> <hr/>

4. Click **OK**.

In the New WebUI

To configure ARM-Assigned radio profiles for an OAW-IAP:

1. Navigate to the **Configuration > Access Points** page.
2. Select the OAW-IAP from the **Access Points** list and click **Edit**.
3. Expand **Radio**.
4. In the **Mode** drop down list box of the desired band, select **Access**.
5. Select the **Adaptive radio management assigned** radio button.
6. Click **Save**.

To configure radio profiles manually for OAW-IAP:

1. Navigate to the **Configuration > Access Points** page.
2. Select the OAW-IAP from the **Access Points** list and click **Edit**.
3. Expand **Radio**.
4. Select a desired radio mode for the respective bands from their **Mode** drop-down list box. The following table describes various configuration modes for an OAW-IAP:



By default, the channel and power for an OAW-IAP are optimized dynamically using ARM. You can override ARM on the 2.4 GHz and 5 GHz bands and set the channel and power manually if desired.

Table 23: OAW-IAP Radio Modes

Mode	Description
Access	<p>In Access mode, the OAW-IAP serves clients, while also monitoring for rogue OAW-IAPs in the background.</p> <p>If the Access mode is selected, perform the following actions:</p> <ol style="list-style-type: none"> 1. Select Administrator assigned in 2.4 GHz and 5 GHz band sections. 2. Select appropriate channel number from the Channel drop-down list for both 2.4 GHz and 5 GHz band sections. 3. Enter appropriate transmit power value in the Transmit power text box in 2.4 GHz and 5 GHz band sections. <p>NOTE: If the transmit power is set to 0, the OAW-IAP is assigned the last transmitted power value set by the ARM.</p>
Monitor	<p>In Monitor mode, the OAW-IAP acts as a dedicated monitor, scanning all channels for rogue OAW-IAPs and clients. You can set one radio on the Monitor mode and the other radio on the access mode, so that the clients can use one radio when the other one is in the Air Monitor mode.</p>
Spectrum Monitor	<p>In Spectrum Monitor mode, the OAW-IAP functions as a dedicated full-spectrum RF monitor, scanning all channels to detect interference, whether from the neighboring OAW-IAPs or from non-WiFi devices such as microwaves and cordless phones.</p> <p>NOTE: In this mode, OAW-IAPs do not provide access services to clients.</p>

4. Click **Save**.

In the CLI

To configure a radio profile:

```
(Instant AP)# wifi0-mode {<access> | <monitor> | <spectrum-monitor>}
(Instant AP)# wifi1-mode {<access> | <monitor> | <spectrum-monitor>}
```

If the access mode is configured, you can configure the channel and transmission power by running the following commands:

```
(Instant AP)# a-channel <channel> <tx-power>
(Instant AP)# g-channel <channel> <tx-power>
```

Configuring Maximum Clients on SSID Radio Profiles

You can set the maximum number of clients in every individual OAW-IAP for SSID profiles operating on the 2.4 GHz and 5 GHz radios. This is a per-AP and per-Radio configuration. This configuration is not persistent and is lost once the OAW-IAP is rebooted.

To configure maximum clients for an SSID radio profile in the privileged exec mode:

```
(Instant AP)# a-max-clients <ssid_profile> <max-clients>
(Instant AP)# g-max-clients <ssid_profile> <max-clients>
```

To view the maximum clients allowed for an SSID profile:

```
(Instant AP)# show a-max-clients <ssid_profile>
(Instant AP)# show g-max-clients <ssid_profile>
```

You can also set the maximum clients when configuring SSID profiles using the **Max Clients Threshold** parameter in the WebUI and **max-clients-threshold** parameter in the AOS-W Instant CLI. For more information, see [Configuring WLAN Settings for an SSID Profile on page 101](#).



If the maximum clients setting is configured multiple times, using either the configuration mode or Privileged EXEC mode, the latest configuration takes precedence.

Enabling Flexible Radio

This feature allows the AP to seamlessly switch between modes where the radio resources are either combined in a single 2x2 radio or separated into two 1x1 radios.

You can configure the flexible radio in the following modes:

- 5 GHz mode: acts as a single radio operating on 5 GHz band
- 2.4 GHz mode: acts as a single radio operating on 2.4 GHz band
- 2.4 GHz and 5 GHz mode: acts as two radio interfaces, one operating on 5 GHz band, and the other on the 2.4 GHz band. By default, the flexible radio is set to this mode.

OAW-AP203H, OAW-AP203R, and OAW-AP203RP access points have one radio each, wherein each radio operates on two bands. When the flexible radio mode is at 2.4 GHz or 5 GHz, the radio operates on one band and the OAW-IAP broadcasts 16 different SSIDs. However, when the flexible radio mode is at 2.4 GHz and 5 GHz, the radio operates on both the bands and the OAW-IAP broadcasts only 8 SSIDs for each band, even if more than 8 SSIDs are configured. The SSIDs with an index value from 0 to 7 will be broadcasted.

You can configure the **Flexible Radio** parameter using the WebUI or the CLI:

In the Old WebUI

To configure flexible radio:

1. On the **Access Points** tab, click the OAW-IAP to modify.
2. Click the **edit** link.
3. Click the **Flexible Radio** tab.
4. Specify the **Mode** from the drop-down list.
5. Click **OK**.
6. Reboot the OAW-IAP.

In the New WebUI

To configure flexible radio:

1. Navigate to **Configuration > Access Points**.
2. Click the OAW-IAP to edit.
3. Click the **Flexible Radio** tab.
4. Specify the **Mode** from the drop-down list.
5. Click **Save**.
6. Reboot the OAW-IAP

In the CLI

To configure the flexible radio mode:

```
(Instant AP)# flex-radio-mode <mode>
```

Dual 5 GHz Radio Mode

This feature allows the OAW-IAP to configure two radio interfaces, both running 5 GHz channel. The OAW-IAPs have two radios, one operating on 2.4 GHz band, and the other on 5 GHz band. OAW-AP-344 and OAW-AP-345 access points support upgrade of the 2.4 GHz radio interface to a 5 GHz radio interface. In dual mode, both radio interfaces can operate on 5 GHz band.

You can configure the **dual-5GHz-mode** parameter using the WebUI or the CLI.

In the Old WebUI

To configure the dual-5 GHz-mode radio:

1. On the **Access Points** tab, click the OAW-IAP to modify.
2. Click the **edit** link.
3. Click the **Radio** tab.
4. Select **Enable** from the **Dual 5G Mode** drop-down list.
5. Click **OK**.
6. Reboot the OAW-IAP.



The dual-5 GHz-mode configuration is currently not supported in the new WebUI.

In the CLI

To configure the dual-5 GHz-mode:

```
(Instant AP)# dual-5GHz-mode {<enable><disable>}
```



The dual-5 GHz-mode command is supported only in OAW-AP-344 and OAW-AP-345 access points.

Configuring Uplink VLAN for an OAW-IAP

AOS-W Instant supports a management VLAN for the uplink traffic on an OAW-IAP. You can configure an uplink VLAN when an OAW-IAP needs to be managed from a non-native VLAN. After an OAW-IAP is provisioned with the uplink management VLAN, all management traffic sent from the OAW-IAP is tagged with the management VLAN.



Ensure that the native VLAN of the OAW-IAP and uplink are not the same.

You can configure the uplink management VLAN on an OAW-IAP by using the WebUI or the CLI.

In the Old WebUI

To configure uplink management VLAN:

1. In the **Access Points** tab, select the OAW-IAP to modify and click **edit**.
2. Select the **Uplink** tab.
3. In the **Uplink Management VLAN** text box, specify the VLAN.
4. Click **OK**.
5. Reboot the OAW-IAP.

In the New WebUI

To configure uplink management VLAN:

1. Navigate to the **Configuration > Access Points** page.
2. Select the OAW-IAP from the **Access Points** list and click **Edit**.
3. Expand **Uplink**.
4. In the **Uplink Management VLAN** text box, specify the VLAN.
5. Click **Save**.

6. Reboot the OAW-IAP.

In the CLI

To configure an uplink VLAN:

```
(Instant AP)# uplink-vlan <VLAN-ID>
```

To view the uplink VLAN status:

```
(Instant AP)# show uplink-vlan
Uplink Vlan Current      :0
Uplink Vlan Provisioned  :1
```

Changing the OAW-IAP Installation Mode

By default, all OAW-IAP models initially ship with an indoor or outdoor installation mode. This means that OAW-IAPs with an indoor installation mode are normally placed in enclosed, protected environments and those with an outdoor installation mode are used in outdoor environments and exposed to harsh elements.

In most countries, there are different channels and power that are allowed for indoor and outdoor operation. You may want to change an OAW-IAP's installation mode from indoor to outdoor or vice versa.

In the Old WebUI

To configure the installation mode for an OAW-IAP, follow these steps:

1. In the **Access Points** tab, select the OAW-IAP to modify and click **edit**.
2. Under the **Installation type** tab, select one of the three installation options - **Default**, **Indoor** or **Outdoor**.



Note that, by default, the **Default** mode is selected. This means that the OAW-IAP installation type is based on the OAW-IAP model.

3. Click **OK**.
4. Reboot the OAW-IAP.

In the New WebUI

To configure the installation mode for an OAW-IAP, follow these steps:

1. Navigate to the **Configuration > Access Points** page.
2. Select the OAW-IAP from the **Access Points** list and click **Edit**.
3. Expand **Installation Type**.



Note that, by default, the **Default** mode is selected. This means that the OAW-IAP installation type is based on the OAW-IAP model.

4. Select one of the three installation options - **Default**, **Indoor** or **Outdoor**.
5. Click **Save**.
6. Reboot the OAW-IAP.

In the CLI

To configure the Installation Type:

```
(Instant AP)# ap-installation <type[default|indoor|outdoor]>
```

To view the installation type of the OAW-IAPs:

```
(Instant AP)# show ap allowed-channels
```

Changing USB Port Status

The USB port can be enabled or disabled based on your uplink preferences. If you do not want to use the cellular uplink or 3G/4G modem in your current network setup, you can set the USB port status to disabled. By default, the USB port status is enabled.

You can change the USB port status by using the WebUI or the CLI.

In the Old WebUI

To change the USB port status:

1. In the **Access Points** tab, select the OAW-IAP to modify and click **edit**.
2. Select the **Uplink** tab.
3. In the **USB port** drop down list box, select either one of the following options:
 - **Disabled**—To disable the port status.
 - **Enabled**—To re-enable the port status.
4. Click **OK**.
5. Reboot the OAW-IAP.

In the New WebUI

To change the USB port status:

1. Navigate to the **Configuration > Access Points** page.
2. Select the OAW-IAP from the **Access Points** list and click **Edit**.
3. Expand **Uplink**.
4. Toggle the **USB port** switch to enable or disable the USB port.
5. Click **Save**.
6. Reboot the OAW-IAP.

In the CLI

To disable the USB port:

```
(Instant AP)# usb-port-disable
```

To re-enable the USB port:

```
(Instant AP)# no usb-port-disable
```

To view the USB port status:

```
(Instant AP)# show ap-env  
Antenna Type:External  
usb-port-disable:1
```

Master Election and Virtual switch

AOS-W Instant does not require an external OmniAccess Mobility Controller to regulate and manage the Wi-Fi network. Instead, every OAW-IAP in the same broadcast domain automatically organizes together to create a virtual switch for the network. The virtual switch represents a single pane of glass that regulates and manages a Wi-Fi network at a single installation location, performing configuration and firmware management of all its

member access points. The virtual switch architecture also ensures that a single AP sets up and manages the VPN tunnel in the data center, if configured, and allows client traffic from all member APs to share the VPN tunnel.

The main capabilities supported by the virtual switch are listed below:

- Acts as a central point of configuration. The configuration is distributed to other OAW-IAPs in a network.
- Provides DHCP servers to the cluster.
- Provides VPN tunnels to a OmniAccess Mobility Controller.

Master Election Protocol

The Master Election Protocol enables the AOS-W Instant network to dynamically elect an OAW-IAP to take on a virtual switch role and allow graceful failover to a new virtual switch when the existing virtual switch is not available. This protocol ensures stability of the network during initial startup or when the virtual switch goes down by allowing only one OAW-IAP to self-elect as a virtual switch. When an existing virtual switch is down, a new virtual switch is elected by the master election protocol. This protocol is initiated by any non-virtual switch OAW-IAP that no longer receives beacon frames from an active virtual switch.

An OAW-IAP is elected as a master by one of the following methods:

1. **Enforced**—In this method, OAW-IAPs in preferred, 3G/4G uplink, mesh portal, or stand-alone mode are elected as the master. However OAW-IAPs in mesh point, or hierarchy down side mode are not elected as the master.
2. **Random Intervals**—In this method, a quick OAW-IAP election takes place when the OAW-IAPs boot. A re-election takes place when the existing master OAW-IAP is down. This results in random election of a master OAW-IAP.
3. **Versus Policy**—This is a method by which multiple OAW-IAPs in a cluster are competing with each other to become a master. The OAW-IAP with higher priority, higher uptime or a bigger MAC address becomes the master. The OAW-IAP with lesser priority, lesser uptime or a smaller MAC address becomes the slave.

Preference to an OAW-IAP with 3G/4G Card

The Master Election Protocol prefers the OAW-IAP with a 3G/4G card when electing a virtual switch for the AOS-W Instant network during the initial setup.

The virtual switch is selected based on the following criteria:

- If there is more than one OAW-IAP with 3G/4G cards, one of these OAW-IAPs is dynamically elected as the virtual switch.
- When an OAW-IAP without 3G/4G card is elected as the virtual switch but is up for less than 5 minutes, another OAW-IAP with 3G/4G card in the network is elected as the virtual switch to replace it and the previous virtual switch reboots.
- When an OAW-IAP without 3G/4G card is already elected as the virtual switch and is up for more than 5 minutes, the virtual switch will not be replaced until it goes down.

Preference to an OAW-IAP with Non-Default IP

The Master Election Protocol prefers an OAW-IAP with non-default IP when electing a virtual switch for the AOS-W Instant network during initial startup. If there are more than one OAW-IAPs with non-default IPs in the network, all OAW-IAPs with default IP will automatically reboot and the DHCP process is used to assign new IP addresses.

Viewing Master Election Details

To verify the status of an OAW-IAP and master election details, execute the following commands:

```
(Instant AP)# show election statistics
(Instant AP)# show summary support
```

Manual Provisioning of Master OAW-IAP

In most cases, the master election process automatically determines the best OAW-IAP that can perform the role of virtual switch, which will apply its image and configuration to all other OAW-IAPs in the same OAW-IAP management VLAN. When the virtual switch goes down, a new virtual switch is elected.

Provisioning an OAW-IAP as a Master OAW-IAP

You can provision an OAW-IAP as a master OAW-IAP by using the WebUI or the CLI.

In the Old WebUI

To provision an OAW-IAP as a master OAW-IAP:

1. In the **Access Points** tab, select the OAW-IAP to modify and click **edit**.
2. Select the **General** tab.
3. In the **Preferred master** drop down list box, select **Enabled**. This option is disabled by default.
4. Click **OK**.

In the New WebUI

To provision an OAW-IAP as a master OAW-IAP:

1. Navigate to the **Configuration > Access Points** page.
2. Select the OAW-IAP from the **Access Points** list and click **Edit**.
3. Expand **Uplink**.
4. Toggle the **Preferred master** switch to enable or disable the option.
5. Click **Save**.

In the CLI

To provision an OAW-IAP as a master OAW-IAP:

```
(Instant AP)# iap-master
```

To verify if the OAW-IAP is provisioned as master OAW-IAP:

```
(Instant AP)# show ap-env  
Antenna Type:Internal  
Iap_master:1
```



Only one OAW-IAP in a cluster can be configured as the preferred master.

Adding an OAW-IAP to the Network

To add an OAW-IAP to the Instant network, assign an IP address. For more information, see [Assigning an IP address to the OAW-IAP on page 21](#).

After an OAW-IAP is connected to the network, if the Auto-Join feature is enabled, the OAW-IAP inherits the configuration from the virtual switch and is listed in the **Access Points** tab.

If the auto-join mode is disabled, perform the following steps by using the WebUI.

In the Old WebUI:

To add an OAW-IAP to the network:

1. In the **Access Points** tab, click **New**.
2. In the **New Access Point** window, enter the MAC address for the new OAW-IAP.
3. Click **OK**.

In the New WebUI:

To add an OAW-IAP to the network:

1. Navigate to the **Configuration > Access Points** page.
2. Click + in the **Access Points** table.
3. In the **New Access Point** window, enter the MAC address for the new OAW-IAP.
4. Click **OK**.

Removing an OAW-IAP from the Network

You can remove an OAW-IAP from the network by using the WebUI, only if the Auto-Join feature is disabled.



The deleted OAW-IAPs cannot join the Instant network anymore and are not displayed in the WebUI. However, the master OAW-IAP details cannot be deleted from the virtual switch database.

In the Old WebUI

To remove an OAW-IAP from the network:

1. In the **Access Points** tab, select the OAW-IAP to delete.
2. Click the **x** icon displayed beside **edit** button to delete the OAW-IAP.
3. Click **Delete Now** to confirm the deletion.

In the New WebUI

To remove an OAW-IAP from the network:

1. Navigate to the **Configuration > Access Points** page.
2. Select the OAW-IAP from the **Access Points** list and click **Delete**.
3. Click **OK** to confirm the deletion.

Support for BLE Asset Tracking

Starting from AOS-W Instant 6.5.2.0, OAW-IAPs can monitor BLE asset tags to track the location of time-sensitive, high-value assets embedded with BLE tags.

BLE tags are located through the following steps:

1. OAW-IAP beacons scan the network for BLE tags.
2. When a tag is detected, the OAW-IAP beacon sends information about the tag to the OAW-IAP, including the MAC address and RSSI of the tag. This data is maintained in a list by the BLE daemon process on the OAW-IAP.
3. The list of tags is sent from the BLE daemon process on the OAW-IAP to the BLE relay process on the OAW-IAP.
4. The OAW-IAP opens a secure WebSocket connection with the designated WebSocket endpoint on the management server, such as the Meridian editor.
5. After receiving the list of tags from the OAW-IAP, the management server calculates the location of each tag by triangulating the tag's RSSI data on a floor plan.



Each BLE tag must be heard by at least three OAW-IAP beacons for triangulation.

In the CLI

Execute the following command to view the list of BLE tags discovered and reported by the OAW-IAP.

```
(Instant AP) # show ap debug ble-table assettags
```

Execute the following command to manage BLE tag reporting and logging.

```
(Instant AP) (config) # ble_relay mgmt-server type ws <ws-endpoint>
```

Execute the following commands to view BLE tag data:

```
(Instant AP) # show ap debug ble-relay tag-report  
(Instant AP) # show ap debug ble-relay disp-attr  
(Instant AP) # show ap debug ble-relay ws-log  
(Instant AP) # show ap debug ble-relay iot-profile  
(Instant AP) # show ap debug ble-relay jobs  
(Instant AP) # show ap debug ble-relay report
```

ZF Openmatics Support for ZF BLE Tag Communication

You can manage ZF TAGs and implement BLE location service using the third-party ZF Openmatics. To support this feature, Alcatel-Lucent OAW-IAPs with built-in IoT-protocol radio (BLE) are required. You can configure the OAW-IAPs to support ZF Openmatics using the IoT profiles.

Configuring ZF Openmatics

The ZF TAG data scans and provides feedback to the ZF server if the ZF endpoint is configured in the IoT profiles.



The beaconing mode must be enabled on the BLE radio of the OAW-IAP.

Configure the IoT transport profile as follows to enable ZF Openmatics support on the Alcatel-Lucent OAW-IAP:

Configure the end point type for ZF Tags using the following command:

```
(host) (IoT Data Profile "<profile-name>") #endpointtype ZF
```

Configure the end point URL for ZF Tags using the following command:

```
(host) (IoT Data Profile "<profile-name>") # endpointURL https://app.detagtive.com/backend
```



The <https://app.detagtive.com/backend> is just an example. For final URL, please refer to ZF company's latest update.

Configure the username and password for ZF Tags using the following commands:

```
(host) (IoT Data Profile "<profile-name>") #username <username>  
(host) (IoT Data Profile "<profile-name>") #password <password>
```

Configure the transport interval for ZF Tags using the following command:

```
(host) (IoT Data Profile "<profile-name>") #transportInterval 60
```



The default is 300 seconds. The recommended value for ZF is 60 seconds.

Configure the payload content for ZF Tags using the following command:

```
(host) (IoT Data Profile "<profile-name>") #payloadContent ZF-Tag
```

Execute the following command in the CLI to apply the IoT profile on the OAW-IAP:

```
(host) (config) # iot useTransportProfile <Profile>
```

Viewing Third-Party Devices in the BLE Table

Use the following command to view any third-party devices in the BLE table:

```
(host) #show ap debug ble-table generic
```

Viewing the BLE Tag Reports

You can use the following CLI command to view the BLE Relay tag reports:

```
(host) #show ap debug ble-relay tag-report
```

Viewing the BLE Relay Jobs

You can use the following CLI command to view the pending BLE Relay jobs:

```
(host) #show ap debug ble-relay jobs
```

IPM

IPM is a feature that actively measures the power utilization of an OAW-IAP and dynamically adapts to the power budget. The static power management method, in contrast to IPM, limits the operation and performance of an AP based on the worst case power usage model.

IPM dynamically limits the power requirement of an OAW-IAP as per the available power resources. This is in contrast to the existing static power management method where the power profiles such as POE-AF, POE-AT, PoE-DC, or LLDP are hard-coded for each OAW-IAP. In order to manage this prioritization, you can define a set of power reduction steps and associate them with a priority. IPM applies a sequence of power reduction steps as defined by the priority definition until the AP is functioning within the power budget. This happens dynamically as IPM constantly monitors the OAW-IAP power consumption and reacts to over-consumption by applying the next power reduction step in the priority list if the OAW-IAP exceeds the power threshold.

IPM is supported in 300 Series, OAW-AP303H, 310 Series, and 330 Series access points.

Important Points to Remember

- By default, IPM is disabled.
- When enabled, IPM enables all OAW-IAP functionality initially. IPM then proceeds to shut down or restrict functionality if the power usage of the AP goes beyond the power budget of the OAW-IAP.



Some functionality may still be restricted because IPM does not override the pre-existing settings that restrict functionality. For example, USB functionality can be disabled in the provisioning profile regardless of the power source.

Configuring IPM

Setting a low-priority value for a power reduction step reduces the power level sooner than setting a high-priority value for a power reduction step. However, if the power reduction step is of the same type but different level, the smallest reduction should be allocated the lowest priority value so that the power reduction step takes place earlier. For example, the **cpu_throttle_25** or **radio_2ghz_power_3dB** parameter should have a lower priority level than the **cpu_throttle_50** or **radio_2ghz_power_6dB**, respectively, so that IPM reduces the CPU throttle or power usage based on the priority list.

You can configure IPM only through the AOS-W Instant CLI:

In the CLI

To enable IPM:

```
(Instant AP) (config) # ipm  
(Instant AP) (ipm) # enable
```

To alter the IPM priority list:

```
(Instant AP) (ipm)# ipm-power-reduction-step-prio ipm-step ?
cpu_throttle_25      Reduce CPU frequency to 25%
cpu_throttle_50      Reduce CPU frequency to 50%
cpu_throttle_75      Reduce CPU frequency to 75%
disable_alt_eth      Disable 2nd Ethernet port
disable_pse          Disable PSE
disable_usb          Disable USB
radio_2ghz_chain_1x1 Reduce 2GHz chains to 1x1
radio_2ghz_chain_2x2 Reduce 2GHz chains to 2x2
radio_2ghz_chain_3x3 Reduce 2GHz chains to 3x3
radio_2ghz_power_3dB Reduce 2GHz radio power by 3dB from maximum
radio_2ghz_power_6dB Reduce 2GHz radio power by 6dB from maximum
radio_5ghz_chain_1x1 Reduce 5GHz chains to 1x1
radio_5ghz_chain_2x2 Reduce 5GHz chains to 2x2
radio_5ghz_chain_3x3 Reduce 5GHz chains to 3x3
radio_5ghz_power_3dB Reduce 5GHz radio power by 3dB from maximum
radio_5ghz_power_6dB Reduce 5GHz radio power by 6dB from maximum
```

Transmit Power Calculation Support on 200 Series and 300 Series Access Points

This feature allows calculation of the transmit power of each outgoing 802.11 packet so that OAW-IAP adheres to the latest regulatory limits. Also, the MIMO gain is considered while calculating the transmit power. MIMO gain refers to effective increase in EIRP of a packet due to usage of multiple antennae (power gain) and various signal processing techniques such as Cyclic Delay Diversity, transmit beamforming, and so on (correlation gain).

Two new action commands, **a-ant-pol** and **g-ant-pol**, are added to configure the antenna polarization for both the radios. The polarization values can be either 0 or 1.

- 0 indicates that the external antennas are co-polarized.
- 1 indicates that the external antennas are cross polarized.

A new show command **show ap debug power-table** is added that displays the following information:

- Power limit table based on regulatory powers, user configured power, and override powers.
- Board limit table.
- A combination of all the above fields to calculate the actual transmit power of the packets.



This feature is supported on 200 Series and 300 Series access points and the command **show ap debug power-table** does not display any value for 100 Series access points.

This chapter explains the following topics:

- [VLAN Pooling](#)
- [Uplink VLAN Monitoring and Detection on Upstream Devices](#)
- [Multiple Management Interface](#)

VLAN configuration is required for networks with more devices and broadcast traffic on a WLAN SSID or wired profile. Based on the network type and its requirements, you can configure the VLANs for a WLAN SSID or wired port profile.

For more information on VLAN configuration for a WLAN SSID and wired port profile, see [Configuring VLAN Settings for a WLAN SSID Profile on page 108](#) and [Configuring VLAN for a Wired Profile on page 136](#), respectively.

VLAN Pooling

In a single OAW-IAP cluster, a large number of clients can be assigned to the same VLAN. Using the same VLAN for multiple clients can lead to a high level of broadcasts in the same subnet. To manage the broadcast traffic, you can partition the network into different subnets and use L3-mobility between those subnets when clients roam. However, if a large number of clients need to be in the same subnet, you can configure VLAN pooling, in which each client is randomly assigned a VLAN from a pool of VLANs on the same SSID. Thus, VLAN pooling allows automatic partitioning of a single broadcast domain of clients into multiple VLANs.

Uplink VLAN Monitoring and Detection on Upstream Devices

If a client connects to an SSID or a wired interface with VLAN that is not allowed on the upstream device, the client will not be assigned an IP address and thus cannot connect to the Internet. In such a scenario, the WebUI displays an alert. To prevent this issue from recurring, ensure that there is no mismatch in the VLAN configuration.

Multiple Management Interface

Users have an option to create multiple VLAN interfaces on master OAW-IAPs. This option is not supported on slave OAW-IAPs due to the following reasons:

- Only the master can implement NATing.
- VLAN features such as guest VLAN, DRP VLAN, VC VLAN, local DHCP VLAN, and so on are implemented only on the master.

This chapter includes the following topics:

- [IPv6 Notation on page 96](#)
- [Enabling IPv6 Support for OAW-IAP Configuration on page 96](#)
- [Firewall Support for IPv6 on page 98](#)
- [GRE Backup Tunnel on page 98](#)
- [Debugging Commands on page 99](#)

IPv6 Notation

IPv6 is the latest version of IP that is suitable for large-scale IP networks. IPv6 supports a 128-bit address to allow 2^{128} , or approximately 3.4×10^{38} addresses while IPv4 supports only 2^{32} addresses.

The IP address of the IPv6 host is always represented as eight groups of four hexadecimal digits separated by colons. For example `2001:0db8:0a0b:12f0:0000:0000:0000:0001`. However, the IPv6 notation can be abbreviated to compress one or more groups of zeroes or to compress leading or trailing zeroes.

The following examples show various representations of the address

`2001:0db8:0a0b:12f0:0000:0000:0000:0001`

- Valid format—`2001:db8:a0b:12f0::0:0:1`
- Invalid format—`2001:db8:a0b:12f0:::0:1`. The “::” sign appears only once in an address.
- With leading zeros omitted—`2001:db8:a0b:12f0:0:0:0:1`
- Switching from upper to lower case—`2001:DB8:A0B:12f0:0:0:0:1`

IPv6 uses a “/” notation which describes the number of bits in netmask as in IPv4.

`2001:db8::1/128` - Single Host

`2001:db8::/64` - Network



IPv6 configuration is supported on OAW-AP-303P, OAW-303 Series, OAW-318 Series, OAW-AP-374, OAW-AP-375, OAW-AP-377, OAW-AP-344, OAW-AP-345, OAW-AP203H, OAW-AP203R, OAW-AP303H, OAW-AP365, OAW-AP367, OAW-IAP207, OAW-IAP304, OAW-IAP305, OAW-IAP314, OAW-IAP315, OAW-IAP334, OAW-IAP335, OAW-IAP214, OAW-IAP215, OAW-IAP274, OAW-IAP275, OAW-IAP224, and OAW-IAP225 access points.

Enabling IPv6 Support for OAW-IAP Configuration

OAW-IAPs support IPv6 address mode for the following features:

- [Supported IP modes](#)
- [Configuring IPv6 Address for an OAW-IAP](#)
- [RADIUS over IPv6](#)
- [SNMP Over IPv6](#)
- [SNTP Over IPv6](#)

Supported IP modes

AOS-W Instant supports two modes of IP address configuration:

- V4-only—The OAW-IAP would allow IPv6 clients to pass-through just like the previous AOS-W Instant release.
- V4-prefer—Supports both IPv4 and IPv6 addresses. If the OAW-IAP gets both IPv4 and IPv6 responses for a DNS query, then the OAW-IAP would prefer the IPv4 DNS address instead of the IPv6 DNS address.

When the IP mode is set to v4-prefer mode, the OAW-IAP derives a link local IPv6 address and attempts to acquire a routable IPv6 address by monitoring RA packets. OAW-IAP assigns itself to both SLAAC and DHCPv6 client address. OAW-IAPs also support IPv6 DNS server addresses and use these for DNS resolution.

In the CLI:

To enable IPv4 mode or dual stack mode:

```
(Instant AP) (config)# ip-mode {v4-only|v4-prefer}
```

Configuring IPv6 Address for an OAW-IAP

You can enable the IPv6 mode on the OAW-IAP and also configure a virtual switch IPv6 address using the WebUI or the CLI:

In the Old WebUI:

To enable IPv6 and configure virtual switch IPv6 address:

1. Select the **System** option from the top right corner of the page.
2. Under **General**, select the **Allow IPv6 Management** check box.
3. Enter the IP address in the **Virtual Controller IPv6** address text box.
4. Click **OK**.

In the New WebUI:

To enable IPv6 and configure virtual switch IPv6 address:

1. Navigate to the **Configuration > System** page.
2. Under **General**, toggle the **Allow IPv6 Management** switch to enable.
3. Enter the IPv6 address in the **Virtual Controller IPv6** address text box.
4. Click **Save**.

In the CLI:

To configure an IPv6 address for an OAW-IAP:

```
(Instant AP) (config)# virtual-controller-ipv6 <ipv6 address>
```



The virtual switch IPv6 address can be configured only after enabling the v4-prefer mode in the AOS-W Instant CLI.

RADIUS over IPv6

With the address mode set to v4-prefer, the OAW-IAP supports an IPv6 IP address for the RADIUS server. The authentication server configuration can also include the NAS IPv6 address (that defaults to the routable IPv6 address when not configured). RADIUS server supports hostname configuration using IP or FQDN configurations also.

To configure an IPv6 address for the RADIUS server:

```
(Instant AP) (config)# wlan auth-server radiusIPv6  
(Instant AP) (Auth Server "radiusIPv6")# ip <host>
```

```
(Instant AP) (Auth Server "radiusIPv6")# nas-ip <ip_ipv6>
```

SNMP Over IPv6

In this release, you can configure a community string to authenticate messages sent between the virtual switch and the SNMP agent, where the IPv6 address will be used as the virtual switch address. For more information on configuring SNMP parameters, see [Configuring SNMP on page 475](#).

To view the SNMP configuration:

```
(Instant AP)# show running-config|include snmp
snmp-server community e96a5ff136b5f481b6b55af75d7735c16ee1f61ba082d7ee
snmp-server host 2001:470:20::121 version 2c aruba-string inform
```

SNTP Over IPv6

To view the SNTP configuration:

```
(Instant AP)# show running-config|include ntp
ntp-server 2001:470:20::121
```



This feature is supported only on global IPv6 addresses. It is not supported on link local IPv6 addresses.

Firewall Support for IPv6

For a given client, a single ACL is used to firewall both IPv4 and IPv6 rules. A rule **any any match any any any permit** in the access rule configuration will expand to two different ACL entries:

- any any any P6
- any any any P4

Similarly, if any IPv6 specific rule is added. For example, if any DHCPv6 or FTPv6 rule is added, the ACE would be expanded as follows:

```
any 2002::/64 17 0-65535 546-547 6—destined to network 2002::/64 DHCPv6 is denied.
```

```
any 2001::10/128 6 0-65535 20-21 6—destined to host 2001::10 FTP is denied.
```

For all ACLs the OAW-IAP will have an implicit IPv4 and IPv6 **allow all** acl rule.

GRE Backup Tunnel

AOS-W Instant supports configuring a GRE tunnel over IPv6 between an OAW-IAP and a GRE terminating device such as a wireless access gateway or a switch. Starting from Aruba Instant 8.4.0.0, every OAW-IAP in a cluster is able to establish a GRE tunnel over IPv6. Each OAW-IAP can support a primary tunnel and a backup tunnel configuration. However, only one of these tunnels can be active at any given time under manual GRE configuration. This feature also introduces GRE tunnel failover, wherein if the primary GRE tunnel is not reachable, the OAW-IAPs will automatically failover to the backup GRE tunnel. The OAW-IAP uses icmp pings to detect reachability of the primary and backup tunnel endpoints. At any point of time, only one GRE tunnel can stay active.



If a switch is used as the GRE tunnel endpoint, you must manually configure the GRE tunnel in the switch while using manual GRE in the OAW-IAP.

Configuring GRE Backup Tunnel Parameters

You can configure a GRE tunnel over IPv6 between an OAW-IAP and a GRE endpoint. Execute the following commands in the AOS-W Instant CLI:

To configure a primary GRE tunnel endpoint:

```
(Instant AP) (config)# gre primary <name>
```

To configure a backup GRE tunnel endpoint:

```
(Instant AP) (config)# gre backup <name>
```

To remove backup or primary GRE tunnel configuration

```
(Instant AP) (config)# no gre backup | no gre primary
```

To remove the entire GRE configuration:

```
(Instant AP) (config)# no gre backup
```

```
(Instant AP) (config)# no gre primary
```

To prevent the SSID from being disabled during a GRE tunnel failover or recovery:

```
(Instant AP) (config)# gre disable-reconnect-user-on-failover
```

To configure the timer after which the SSIDs should come up once the tunnel status is UP:

```
(Instant AP) (config)# gre reconnect-time-on-failover <Time in secs>
```

To configure the number of ping packets to be missed to mark the tunnel status as DOWN:

```
(Instant AP) (config)# gre ping-retry-count <new_count>
```

To configure the time interval at which a ping probe packet needs to be sent:

```
(Instant AP) (config)# gre ping-frequency <time_in_secs>
```

To disable the hold on timer from running on the OAW-IAP:

```
(Instant AP) (config)# gre disable-preemption
```

To configure the hold down time interval before tunnel recovery from backup to primary:

```
(Instant AP) (config)# gre hold-time <time_in_secs>
```

Verifying the Configuration

Use the following commands to verify the GRE tunnel configuration on an OAW-IAP.

To view the various parameters configured for the GRE tunnel on the OAW-IAP:

```
(Instant AP)# show gre config
```

To display the various parameters that indicate the status of the GRE tunnel:

```
(Instant AP)# show gre status
```

Debugging Commands

Use the following commands to troubleshoot issues pertaining to IPv6 configuration:

- `show ipv6 interface brief` and `show ipv6 interface details`—displays the configured IPv6 address, and any duplicate addresses.
- `show ipv6 route`—displays the IPv6 routing information.
- `show datapath ipv6 session`—displays IPv6 sessions.
- `show datapath ipv6 user`—displays IPv6 client details.
- `show clients` and `show clients debug`—displays the details about OAW-IAP clients.

This chapter provides the following information:

- [Configuring Wireless Network Profiles on page 100](#)
- [Configuring Fast Roaming for Wireless Clients on page 124](#)
- [Configuring Modulation Rates on a WLAN SSID on page 128](#)
- [Disabling Short Preamble for Wireless Client on page 131](#)
- [Multi-User-MIMO on page 129](#)
- [Management Frame Protection on page 130](#)
- [High Efficiency WLAN \(HEW\) on page 130](#)
- [Disabling a WLAN SSID Profile on page 131](#)
- [Editing a WLAN SSID Profile on page 132](#)
- [Deleting a WLAN SSID Profile on page 132](#)

Configuring Wireless Network Profiles

During start up, a wireless client searches for radio signals or beacon frames that originate from the nearest OAW-IAP. After locating the OAW-IAP, the following transactions take place between the client and the OAW-IAP:

1. Authentication—The OAW-IAP communicates with a RADIUS server to validate or authenticate the client.
2. Connection—After successful authentication, the client establishes a connection with the OAW-IAP.

Network Types

AOS-W Instant wireless networks are categorized as:

- **Employee network**—An Employee network is a classic Wi-Fi network. This network type is used by the employees in an organization and it supports passphrase-based or 802.1X-based authentication methods. Employees can access the protected data of an enterprise through the employee network after successful authentication. The employee network is selected by default during a network profile configuration.
- **Voice network**—This Voice network type allows you to configure a network profile for devices that provide only voice services—for example, devices such as handsets or applications that require voice traffic prioritization.
- **Guest network**—The Guest wireless network is created for guests, visitors, contractors, and any non-employee users who use the enterprise Wi-Fi network. The virtual switch assigns the IP address for the guest clients. Captive portal or passphrase-based authentication methods can be set for this wireless network. Typically, a guest network is an unencrypted network. However, you can specify the encryption settings when configuring a guest network.



When a client is associated to the Voice network, all data traffic is marked and placed into the high-priority queue in the QoS.

To configure a new wireless network profile, complete the following procedures:

1. [Configuring WLAN Settings](#)
2. [Configuring VLAN Settings](#)

3. [Configuring Security Settings](#)
4. [Configuring Access Rules for a Network](#)

Configuring WLAN Settings for an SSID Profile

You can configure WLAN settings using the WebUI or the CLI.

In the Old WebUI

To configure WLAN settings:

1. Under the **Networks** tab of the AOS-W Instant main window, select **New**. The **New WLAN** window is displayed.
2. Enter a name that uniquely identifies a wireless network in the **Name** field.



The SSID name must be unique and may contain any special character except for ' and ''.

3. Based on the type of network profile, select any of the following options under **Primary usage**:
 - **Employee**
 - **Voice**
 - **Guest**
4. Click the **Show advanced options** link at the bottom of the window. The advanced options for configuration are displayed. Specify the following parameters as required.

Table 24: WLAN Configuration Parameters

Parameter	Description
Broadcast filtering	Select any of the following values: <ul style="list-style-type: none"> ■ All—When set to All, the OAW-IAP drops all broadcast and multicast frames except DHCP and ARP, IGMP group queries, and IPv6 neighbor discovery protocols. ■ ARP—When set to ARP, the OAW-IAP drops all broadcast and multicast frames except DHCP and ARP, IGMP group queries, and IPv6 neighbor discovery protocols; additionally, it converts ARP requests to unicast and send frames directly to the associated client. The broadcast filtering option is set to ARP by default when an SSID profile is created. ■ Unicast-ARP-Only—When set to Unicast-ARP-Only, the OAW-IAP allows all broadcast and multicast frames as it is, however the ARP requests are converted to unicast frames and sends them to the associated clients. ■ Disabled—When set to Disabled, all broadcast and multicast traffic is forwarded to the wireless interfaces.
Multicast transmission optimization	Select Enabled if you want the OAW-IAP to select the optimal rate for sending 802.11 broadcast and multicast frames based on the lowest of unicast rates across all associated clients. When this option is enabled, multicast traffic can be sent at up to 24 Mbps. The default rate of sending frames for 2.4 GHz is 1 Mbps and that for 5 GHz is 6 Mbps. This option is disabled by default.
Dynamic multicast optimization	Select Enabled to allow the OAW-IAP to convert multicast streams into unicast streams over the wireless link. Enabling DMO enhances the quality and reliability of streaming video, while preserving the bandwidth available to the non-video clients. NOTE: When you enable DMO on multicast SSID profiles, ensure that the DMO feature is enabled on all SSIDs configured in the same VLAN.

Table 24: WLAN Configuration Parameters

Parameter	Description
DMO channel utilization threshold	Specify a value to set a threshold for DMO channel utilization. With DMO, the OAW-IAP converts multicast streams into unicast streams as long as the channel utilization does not exceed this threshold. The default value is 90% and the maximum threshold value is 100%. When the threshold is reached or exceeds the maximum value, the OAW-IAP sends multicast traffic over the wireless link.
Transmit Rates	Specify the following parameters: <ul style="list-style-type: none"> ■ 2.4 GHz—If the 2.4 GHz band is configured on the OAW-IAP, specify the minimum and maximum transmission rate. The default value for minimum transmission rate is 1 Mbps and maximum transmission rate is 54 Mbps. ■ 5 GHz—If the 5 GHz band is configured on the OAW-IAP, specify the minimum and maximum transmission rate. The default value for minimum transmission rate is 6 Mbps and maximum transmission rate is 54 Mbps.
Band	Select a value to specify the band at which the network transmits radio signals. You can set the band to 2.4 GHz , 5 GHz , or All . The All option is selected by default.
DTIM interval	The DTIM interval indicates the DTIM period in beacons, which can be configured for every WLAN SSID profile. The DTIM interval determines how often the OAW-IAP should deliver the buffered broadcast and multicast frames to associated clients in the powersave mode. The default value is 1 beacon, which means the client checks for buffered data on the OAW-IAP at every beacon. You can also configure a higher DTIM value for power saving.
Min RSSI for probe request	Sets a minimum RSSI threshold for probe requests.
Min RSSI for auth request	Sets a minimum RSSI threshold for authentication requests.
Very high throughput	Enables the VHT function on OAW-IAP devices that support VHT. For 802.11ac OAW-IAPs, the VHT function is enabled by default. However, you can disable the VHT function if you want the 802.11ac OAW-IAPs to function as 802.11n OAW-IAPs. If VHT is configured or disabled on an SSID, the changes will apply only to the SSID on which it is enabled or disabled.
Zone	Specify the zone name for the SSID profile. When the zone is defined in SSID profile and if the same zone is defined on an OAW-IAP, the SSID is created on that OAW-IAP. Enter multiple zone name as comma-separated values. For more information on configuring zone details, see Configuring Zone Settings on an OAW-IAP on page 78 .
Time Range	Click Edit , select a Time Range Profile from the list and specify if the profile must be enabled or disabled for the SSID, and then click OK .
Bandwidth Limits	Select the required options under Bandwidth Limits : <ul style="list-style-type: none"> ■ Airtime—Select this check box and specify an aggregate amount of airtime that all clients in this network can use for sending and receiving data. Specify the airtime percentage. ■ Each radio—Select this check box to specify an aggregate amount of throughput that each radio is allowed to provide for the connected clients. ■ Downstream and Upstream—Specify the downstream and upstream rates within a range of 1 to 65,535 Kbps for the SSID users. If the assignment is specific for each user, select the Per user check box. <p>NOTE: The bandwidth limit set in this method is implemented at a per-AP level and not cluster level.</p>

Table 24: WLAN Configuration Parameters

Parameter	Description
WMM	<p>Configure the following options for WMM traffic management. WMM supports voice, video, best effort, and background access categories. To allocate bandwidth for the following types of traffic, specify a percentage value under Share. To configure DSCP mapping, specify a value under DSCP Mapping.</p> <ul style="list-style-type: none"> ■ Background WMM—For background traffic such as file downloads or print jobs. ■ Best effort WMM—For best effort traffic such as traffic from legacy devices or traffic from applications or devices that do not support QoS. ■ Video WMM—For video traffic generated from video streaming. ■ Voice WMM—For voice traffic generated from the incoming and outgoing voice communication. <p>For more information on WMM traffic and DSCP mapping, see WMM Traffic Management on page 370.</p> <p>For voice traffic and Spectralink Voice Prioritization, configure the following parameters:</p> <ul style="list-style-type: none"> ■ Traffic Specification (TSPEC)—To prioritize time-sensitive traffic such as voice traffic initiated by the client, select the Traffic Specification (TSPEC) check box. ■ TSPEC Bandwidth—To reserve bandwidth, set the TPSEC bandwidth to the desired value within the range of 200–600,000 Kbps. The default value is 2000 Kbps. ■ Spectralink Voice Protocol (SVP)—Select the check box to prioritize voice traffic for SVP handsets.
Content filtering	Select Enabled to route all DNS requests for the non-corporate domains to OpenDNS on this network.
Inactivity timeout	Specify an interval for session timeout in seconds, minutes, or hours. If a client session is inactive for the specified duration, the session expires and the user is required to log in again. You can specify a value within the range of 60–86,400 seconds (24 hours) for a client session. The default value is 1000 seconds.
Deauth Inactive Clients	Select Enabled to allow the OAW-IAP to send a deauthentication frame to the inactive client and clear client entry.
SSID	Select the Hide check box if you do not want the SSID (network name) to be visible to users. Select the Disable check box if you want to disable the SSID. On selecting this, the SSID will be disabled, but will not be removed from the network. By default, all SSIDs are enabled.
Out of service (OOS)	<p>Enable or disable the SSID based on the following OOS states of the OAW-IAP:</p> <ul style="list-style-type: none"> ■ VPN down ■ Uplink down ■ Internet down ■ Primary uplink down <p>The network will be out of service when selected event occurs and the SSID is enabled or disabled as per the configuration settings applied. For example, if you select the VPN down option from the drop-down list and set the status to enabled, the SSID is enabled when the VPN connection is down and is disabled when the VPN connection is restored.</p>
OOS time (global)	Configure a hold time interval in seconds within a range of 30–300 seconds, after which the out-of-service operation is triggered. For example, if the VPN is down and the configured hold time is 45 seconds, the effect of this out-of-service state impacts the SSID availability after 45 seconds.
Max clients threshold	Specify the maximum number of clients that can be configured for each BSSID on a WLAN. You can specify a value within the range of 0–255. The default value is 64. NOTE: When the Max clients threshold parameter is configured, the value is applicable to every OAW-IAP in a cluster.

Table 24: WLAN Configuration Parameters

Parameter	Description
SSID Encoding	To encode the SSID, select UTF-8. By default, the SSIDs are not encoded. NOTE: When a wireless SSID is encoded, by default, UTF-8 is added to the access rules that are active on the SSID. However this does not apply for the access rules that are configured separately for the SSID. UTF-8 is not supported for wired networks.
ESSID	Name that uniquely identifies a wireless network. The network name, or ESSID can be up to 32 ASCII characters, if it contains Unicode, depending on the language, the maximum characters vary. For example, ESSID could be up to 10 Chinese characters or 16 extended ASCII characters. If the ESSID includes spaces, you must enclose it in quotation marks.
Deny inter user bridging	When enabled, the bridging traffic between two clients that are connected to the same SSID on the same VLAN is disabled. The clients can connect to the Internet, but cannot communicate with each other, and the bridging traffic between the clients is sent to the upstream device to make the forwarding decision.
Openflow	When enabled, users can run and manage multiple instances of the control-plane and dataplane from a centralized location. OpenFlow also ensures uniform policy enforcement.

5. Click **Next** to configure VLAN settings. For more information, see [Configuring VLAN Settings for a WLAN SSID Profile on page 108](#).

In the New WebUI

To configure WLAN settings:

1. Navigate to the **Configuration > Networks** page.
2. Under **Networks**, click **+**. The **Create a new network** window is displayed.
3. Under Basic option, Enter a name that uniquely identifies a wireless network in the **Name** field.



The SSID name must be unique and may contain any special character except for ' and ''.

4. In the **Type** drop-down list, select **Wireless**.
5. Based on the type of network profile, select any of the following options for **Primary usage**:
 - **Employee**
 - **Voice**
 - **Guest**
6. Click the **Show advanced options** link at the bottom of the page. Specify the following parameters as required.

Table 25: WLAN Configuration Parameters

Parameter	Description
Broadcast/Multicast	
Broadcast filtering	<p>Select any of the following values:</p> <ul style="list-style-type: none"> ■ All—When set to All, the OAW-IAP drops all broadcast and multicast frames except DHCP and ARP, IGMP group queries, and IPv6 neighbor discovery protocols. ■ ARP—When set to ARP, the OAW-IAP drops all broadcast and multicast frames except DHCP and ARP, IGMP group queries, and IPv6 neighbor discovery protocols; additionally, it converts ARP requests to unicast and send frames directly to the associated client. The broadcast filtering option is set to ARP by default when an SSID profile is created. ■ Unicast-ARP-Only—When set to Unicast-ARP-Only, the OAW-IAP allows all broadcast and multicast frames as it is, however the ARP requests are converted to unicast frames and sends them to the associated clients. ■ Disabled—When set to Disabled, all broadcast and multicast traffic is forwarded to the wireless interfaces.
Multicast transmission optimization	<p>Click the toggle switch if you want the OAW-IAP to select the optimal rate for sending 802.11 broadcast and multicast frames based on the lowest of unicast rates across all associated clients. When this parameter is enabled, multicast traffic can be sent at up to 24 Mbps. The default rate of sending frames for 2.4 GHz is 1 Mbps and that for 5 GHz is 6 Mbps. This parameter is disabled by default.</p>
Dynamic multicast optimization	<p>Click the toggle switch to allow the OAW-IAP to convert multicast streams into unicast streams over the wireless link. Enabling DMO enhances the quality and reliability of streaming video, while preserving the bandwidth available to the non-video clients.</p> <p>NOTE: When you enable DMO on multicast SSID profiles, ensure that the DMO feature is enabled on all SSIDs configured in the same VLAN.</p>
DMO channel utilization threshold	<p>Specify a value to set a threshold for DMO channel utilization. With DMO, the OAW-IAP converts multicast streams into unicast streams as long as the channel utilization does not exceed this threshold. The default value is 90% and the maximum threshold value is 100%. When the threshold is reached or exceeds the maximum value, the OAW-IAP sends multicast traffic over the wireless link.</p>
Transmit Rates	
Transmit Rates	<p>Specify the following parameters:</p> <ul style="list-style-type: none"> ■ 2.4 GHz—If the 2.4 GHz band is configured on the OAW-IAP, specify the minimum and maximum transmission rate. The default value for minimum transmission rate is 1 Mbps and maximum transmission rate is 54 Mbps. ■ 5 GHz—If the 5 GHz band is configured on the OAW-IAP, specify the minimum and maximum transmission rate. The default value for minimum transmission rate is 6 Mbps and maximum transmission rate is 54 Mbps.
802.11	
Band	<p>Select a value to specify the band at which the network transmits radio signals. You can set the band to 2.4 GHz, 5 GHz, or All. The All option is selected by default.</p>
DTIM interval	<p>The DTIM interval indicates the DTIM period in beacons, which can be configured for every WLAN SSID profile. The DTIM interval determines how often the OAW-IAP should deliver the buffered broadcast and multicast frames to associated clients in the powersave mode. The default value is 1 beacon, which means the client checks for buffered data on the OAW-IAP at every beacon. You can also configure a higher DTIM value for power saving.</p>
Min RSSI for probe request	<p>Sets a minimum RSSI threshold for probe requests.</p>

Table 25: WLAN Configuration Parameters

Parameter	Description
Min RSSI for auth request	Sets a minimum RSSI threshold for authentication requests.
Very high throughput	Enables the VHT function on OAW-IAP devices that support VHT. For 802.11ac OAW-IAPs, the VHT function is enabled by default. However, you can disable the VHT function if you want the 802.11ac OAW-IAPs to function as 802.11n OAW-IAPs. If VHT is configured or disabled on an SSID, the changes will apply only to the SSID on which it is enabled or disabled.
High efficiency	Defines 802.11ax spectrum efficiency and area throughput on both the 2.4 GHz and 5 GHz frequency bands.
Zone	Specify the zone name for the SSID profile. When the zone is defined in SSID profile and if the same zone is defined on an OAW-IAP, the SSID is created on that OAW-IAP. Enter multiple zone name as comma-separated values. For more information on configuring zone details, see Configuring Zone Settings on an OAW-IAP on page 78 .
Time Range	Click Edit , select a Time Range Profile from the list, and specify if the profile must be enabled or disabled for the SSID, and then click OK .
Bandwidth Limits	Select the required options under Bandwidth Limits : <ul style="list-style-type: none"> ■ Airtime—Click the toggle switch and specify an aggregate amount of airtime that all clients in this network can use for sending and receiving data. Specify the airtime percentage. ■ Each radio—Click the toggle switch to specify an aggregate amount of throughput that each radio is allowed to provide for the connected clients. ■ Downstream and Upstream—Specify the downstream and upstream rates within a range of 1 to 65,535 Kbps for the SSID users. If the assignment is specific for each user, select the Per user check box. <p>NOTE: The bandwidth limit set in this method is implemented at a per-AP level and not cluster level.</p>
WMM	Configure the following options for WMM traffic management. WMM supports voice, video, best effort, and background access categories. To allocate bandwidth for the following types of traffic, specify a percentage value under Share . To configure DSCP mapping, specify a value under DSCP Mapping . <ul style="list-style-type: none"> ■ Background WMM—For background traffic such as file downloads or print jobs. ■ Best effort WMM—For best effort traffic such as traffic from legacy devices or traffic from applications or devices that do not support QoS. ■ Video WMM—For video traffic generated from video streaming. ■ Voice WMM—For voice traffic generated from the incoming and outgoing voice communication. <p>For more information on WMM traffic and DSCP mapping, see WMM Traffic Management on page 370.</p> <p>For voice traffic and Spectralink Voice Prioritization, configure the following parameters: <ul style="list-style-type: none"> ■ Traffic Specification (TSPEC)—To prioritize time-sensitive traffic such as voice traffic initiated by the client, click the Traffic Specification (TSPEC) toggle switch. ■ TSPEC Bandwidth—To reserve bandwidth, set the TPSEC bandwidth to the desired value within the range of 200–600,000 Kbps. The default value is 2000 Kbps. ■ Spectralink Voice Protocol (SVP)—Click the toggle switch to prioritize voice traffic for SVP handsets. </p>
Miscellaneous	
Content filtering	Click the toggle switch to route all DNS requests for the non-corporate domains to OpenDNS on this network.

Table 25: WLAN Configuration Parameters

Parameter	Description
Inactivity timeout	Specify an interval for session timeout in seconds, minutes, or hours. If a client session is inactive for the specified duration, the session expires and the user is required to log in again. You can specify a value within the range of 60–86,400 seconds (24 hours) for a client session. The default value is 1000 seconds.
Deauth inactive clients	Click the toggle switch to allow the OAW-IAP to send a deauthentication frame to the inactive client and clear client entry.
SSID	Select the Hide check box if you do not want the SSID (network name) to be visible to users. Select the Disable check box if you want to disable the SSID. On selecting this, the SSID will be disabled, but will not be removed from the network. By default, all SSIDs are enabled.
Out of service (OOS)	Enable or disable the SSID based on the following OOS states of the OAW-IAP: <ul style="list-style-type: none"> ■ VPN down ■ Uplink down ■ Internet down ■ Primary uplink down The network will be out of service when selected event occurs and the SSID is enabled or disabled as per the configuration settings applied. For example, if you select the VPN down option from the drop-down list and set the status to enabled, the SSID is enabled when the VPN connection is down and is disabled when the VPN connection is restored.
OOS time (global)	Configure a hold time interval in seconds within a range of 30–300 seconds, after which the out-of-service operation is triggered. For example, if the VPN is down and the configured hold time is 45 seconds, the effect of this out-of-service state impacts the SSID availability after 45 seconds.
Max clients threshold	Specify the maximum number of clients that can be configured for each BSSID on a WLAN. You can specify a value within the range of 0–255. The default value is 64. NOTE: When the Max clients threshold parameter is configured, the value is applicable to every OAW-IAP in a cluster.
SSID Encoding	To encode the SSID, select UTF-8. By default, the SSIDs are not encoded. NOTE: When a wireless SSID is encoded, by default, UTF-8 is added to the access rules that are active on the SSID. However this does not apply for the access rules that are configured separately for the SSID. UTF-8 is not supported for wired networks.
ESSID	Name that uniquely identifies a wireless network. The network name, or ESSID can be up to 32 ASCII characters, if it contains Unicode, depending on the language, the maximum characters vary. For example, ESSID could be up to 10 Chinese characters or 16 extended ASCII characters. If the ESSID includes spaces, you must enclose it in quotation marks.
Deny inter user bridging	When enabled, the bridging traffic between two clients that are connected to the same SSID on the same VLAN is disabled. The clients can connect to the Internet, but cannot communicate with each other, and the bridging traffic between the clients is sent to the upstream device to make the forwarding decision.
Openflow	When enabled, users can run and manage multiple instances of the control-plane and dataplane from a centralized location. OpenFlow also ensures uniform policy enforcement.

7. Click **Next** to configure VLAN settings. For more information, see [Configuring VLAN Settings for a WLAN SSID Profile on page 108](#).

In the CLI

To configure WLAN settings for an SSID profile, execute the following command in the configuration mode of the CLI.

```

(Instant AP) (config)# wlan ssid-profile <name>
(Instant AP) (SSID Profile <name>)# essid <ESSID-name>
(Instant AP) (SSID Profile <name>)# type {<Employee>|<Voice>|<Guest>}
(Instant AP) (SSID Profile <name>)# broadcast-filter {All|ARP|Unicast-ARP-Only|Disabled}
(Instant AP) (SSID Profile <name>)# dtim-period <number-of-beacons>
(Instant AP) (SSID Profile <name>)# multicast-rate-optimization
(Instant AP) (SSID Profile <name>)# dynamic-multicast-optimization
(Instant AP) (SSID Profile <name>)# dmo-channel-utilization-threshold
(Instant AP) (SSID Profile <name>)# a-max-tx-rate <rate>
(Instant AP) (SSID Profile <name>)# a-min-tx-rate <rate>
(Instant AP) (SSID Profile <name>)# g-max-tx-rate <rate>
(Instant AP) (SSID Profile <name>)# g-min-tx-rate <rate>
(Instant AP) (SSID Profile <name>)# zone <zone>
(Instant AP) (SSID Profile <name>)# bandwidth-limit <limit>
(Instant AP) (SSID Profile <name>)# per-user-bandwidth-limit <limit>
(Instant AP) (SSID Profile <name>)# air-time-limit <limit>
(Instant AP) (SSID Profile <name>)# wmm-background-dscp <dscp>
(Instant AP) (SSID Profile <name>)# wmm-background-share <share>
(Instant AP) (SSID Profile <name>)# wmm-best-effort-dscp <dscp>
(Instant AP) (SSID Profile <name>)# wmm-best-effort-share <share>
(Instant AP) (SSID Profile <name>)# wmm-video-dscp <dscp>
(Instant AP) (SSID Profile <name>)# wmm-video-share <share>
(Instant AP) (SSID Profile <name>)# wmm-voice-dscp <dscp>
(Instant AP) (SSID Profile <name>)# wmm-voice-share <share>
(Instant AP) (SSID Profile <name>)# rf-band {<2.4>|<5>|<all>}
(Instant AP) (SSID Profile <name>)# content-filtering
(Instant AP) (SSID Profile <name>)# mfp-capable
(Instant AP) (SSID Profile <name>)# mfp-required
(Instant AP) (SSID Profile <name>)# hide-ssid
(Instant AP) (SSID Profile <name>)# out-of-service <def> <name>
(Instant AP) (SSID Profile <name>)# time-range <profile name> {<Enable>|<Disable>}
(Instant AP) (SSID Profile <name>)# inactivity-timeout <interval>
(Instant AP) (SSID Profile <name>)# work-without-uplink
(Instant AP) (SSID Profile <name>)# local-probe-req-thresh <threshold>
(Instant AP) (SSID Profile <name>)# max-clients-threshold <number-of-clients>

```

Temporal Diversity and Maximum Retries

When clients are not responding to 802.11 packets with the **temporal-diversity** parameter disabled, which is the default setting, OAW-IAPs can attempt only hardware retries. But if this parameter is enabled when the clients are not responding to 802.11 packets, OAW-IAPs can perform two hardware retries. When the hardware retry attempts fail, OAW-IAPs can perform software retries.

The **max-retries** parameter indicates the maximum number of attempts the OAW-IAP performs when clients are not responding to 802.11 packets. By default, the OAW-IAP attempts a maximum of eight retries when clients are not responding to 802.11 packets.

The following example shows the configuration of **temporal-diversity** and **max-retries** in a WLAN SSID profile:

```

(Instant AP) (config) # wlan ssid-profile Name
(Instant AP) (SSID Profile "Name") # temporal-diversity
(Instant AP) (SSID Profile "Name") # max-retries 3

```

Configuring VLAN Settings for a WLAN SSID Profile

If you are creating a new SSID profile, complete the WLAN Settings procedure before configuring the VLAN. For more information, see [Configuring WLAN Settings for an SSID Profile on page 101](#).

You can configure VLAN settings for an SSID profile using the AOS-W Instant UI or the CLI.

In the Old WebUI

To configure VLAN settings for an SSID:

1. In the **Networks** tab, select the network you want to edit and click **edit**.
2. Select the **VLAN** tab.
3. Select any one for the following options for **Client IP assignment**:
 - **Virtual Controller managed**—On selecting this option, the wired client obtains the IP address from the virtual switch. When this option is used, the source IP address is translated to the physical IP address of the master OAW-IAP for all client traffic that goes through this interface. The virtual switch can also assign a guest VLAN to the client.
 - **Network assigned**—On selecting this option, the IP address is obtained from the network.
4. Based on the type of client IP assignment mode selected, you can configure the VLAN assignment for clients as described in the following table:

Table 26: IP and VLAN Assignment for WLAN SSID Clients

Client IP Assignment	Client VLAN Assignment
Virtual Controller managed	<p>If Virtual Controller assigned is selected for client IP assignment, the virtual switch creates a private subnet and VLAN on the OAW-IAP for the wireless clients. The NAT for all client traffic that goes out of this interface is carried out at the source. This setup eliminates the need for complex VLAN and IP address management for a multi-site wireless network. On selecting this option, the following client VLAN assignment options are available:</p> <ul style="list-style-type: none">■ Default—When selected, the default VLAN as determined by the virtual switch is assigned for clients.■ Custom—When selected, you can specify a custom VLAN assignment option. You can select an existing DHCP scope for client IP and VLAN assignment or you can create a new DHCP scope by selecting New. For more information on DHCP scopes, see Configuring DHCP Scopes on page 276.
Network assigned	<p>If Network assigned is selected, you can specify any of the following options for the Client VLAN assignment.</p> <ul style="list-style-type: none">■ Default—On selecting this option, the client obtains the IP address in the same subnet as the OAW-IAPs. By default, the client VLAN is assigned to the native VLAN on the wired network.■ Static—On selecting this option, you need to specify any one of the following: a single VLAN, a comma separated list of VLANs, or a range of VLANs for all clients on this network. Select this option for configuring VLAN pooling.■ Dynamic—On selecting this option, you can assign the VLANs dynamically from a DHCP server. To create VLAN assignment rules, click New to assign the user to a VLAN. In the New VLAN Assignment Rule window, enter the following information:<ul style="list-style-type: none">■ Attribute—Select an attribute returned by the RADIUS server during authentication.■ Operator—Select an operator for matching the string.■ String—Enter the string to match .■ VLAN—Enter the VLAN to be assigned.

5. Click **Next** to configure security settings for the network. For more information, see [Configuring Security Settings for a WLAN SSID Profile on page 111](#).

In the New WebUI

To configure VLAN settings for an SSID:

1. In the **Configuration > Networks** page.
2. Under **Networks** select the network you want to configure and click **edit**.
3. Under the **VLAN** tab, select any of the following options for **Client IP assignment**:

- **Virtual Controller managed**—On selecting this option, the wired client obtains the IP address from the virtual switch. When this option is used, the source IP address is translated to the physical IP address of the master OAW-IAP for all client traffic that goes through this interface. The virtual switch can also assign a guest VLAN to the client.
 - **Network assigned**—On selecting this option, the IP address is obtained from the network.
4. Based on the type of client IP assignment mode selected, you can configure the VLAN assignment for clients as described in the following table:

Table 27: IP and VLAN Assignment for WLAN SSID Clients

Client IP Assignment	Client VLAN Assignment
<p>Virtual Controller managed</p>	<p>If Virtual Controller managed is selected for client IP assignment, the virtual switch creates a private subnet and VLAN on the OAW-IAP for the wireless clients. The NAT for all client traffic that goes out of this interface is carried out at the source. This setup eliminates the need for complex VLAN and IP address management for a multisite wireless network. On selecting this option, the following client VLAN assignment options are displayed:</p> <ul style="list-style-type: none"> ■ Default—When selected, the default VLAN as determined by the virtual switch is assigned for clients. ■ Custom—When selected, you can specify a custom VLAN assignment option. You can select an existing DHCP scope for client IP and VLAN assignment. For more information on DHCP scopes, see Configuring DHCP Scopes on page 276.
<p>Network assigned</p>	<p>If Network assigned is selected, you can specify any of the following options for the Client VLAN assignment.</p> <ul style="list-style-type: none"> ■ Default—On selecting this option, the client obtains the IP address in the same subnet as the OAW-IAPs. By default, the client VLAN is assigned to the native VLAN on the wired network. ■ Static—On selecting this option, you need to specify any one of the following in the VLAN ID text box: a single VLAN, a comma separated list of VLANs, or a range of VLANs for all clients on this network. Select this option for configuring VLAN pooling. ■ Dynamic—On selecting this option, you can assign the VLANs dynamically from a DHCP server. To create VLAN assignment rules, click + to assign the user to a VLAN. In the New VLAN Assignment Rules window, enter the following information: <ul style="list-style-type: none"> ■ Attribute—Select an attribute returned by the RADIUS server during authentication. ■ Operator—Select an operator for matching the string. ■ String—Enter the string to match. ■ VLAN—Enter the VLAN to be assigned.

5. Click **Next** to configure security settings for the network. For more information, see [Configuring Security Settings for a WLAN SSID Profile on page 111](#).

In the CLI

To manually assign VLANs for WLAN SSID users:

```
(Instant AP) (config)# wlan ssid-profile <name>
(Instant AP) (SSID Profile <name>)# vlan <vlan-ID>
```

To create a new VLAN assignment rule:

```
(Instant AP) (config)# wlan ssid-profile <name>
(Instant AP) (SSID Profile <name>)# set-vlan <attribute> {{contains|ends-with|equals|matches-regular-expression|not-equals|starts-with} <operand> <vlan>|value-of}
```

Enforcing DHCP

Starting from AOS-W Instant 6.4.3.4-4.2.1.0, you can configure a WLAN SSID profile to enforce DHCP on OAW-IAP clients.

When DHCP is enforced:

- A layer-2 user entry is created when a client associates with an OAW-IAP.
- The client DHCP state and IP address are tracked.
- When the client obtains an IP address from DHCP, the DHCP state changes to complete.
- If the DHCP state is complete, a layer-3 user entry is created.
- When a client roams between the OAW-IAPs, the DHCP state and the client IP address will be synchronized with the new OAW-IAP.

By default, enforcing DHCP feature is disabled.

To enforce DHCP:

```
(Instant AP) (config)# wlan ssid-profile <name>
(Instant AP) (SSID Profile <name>)# enforce-dhcp
```

Configuring Security Settings for a WLAN SSID Profile

This section describes the procedure for configuring security settings for an Employee or Voice network. For information on guest network configuration, see [Captive Portal for Guest Access](#).



If you are creating a new SSID profile, configure the WLAN and VLAN settings before defining security settings. For more information, see [Configuring WLAN Settings for an SSID Profile on page 101](#) and [Configuring VLAN Settings for a WLAN SSID Profile on page 108](#).

Configuring Security Settings for an Employee or Voice Network

You can configure security settings for an Employee or Voice network by using the AOS-W Instant UI or the CLI.

In the Old WebUI

To configure security settings for an Employee or Voice network:

1. In the **Networks** tab, select the network you want to edit and click **edit**.
2. Select the **Security** tab.
3. Specify any of the following types of security levels by moving the slider to a desired level:
 - **Enterprise**—On selecting the enterprise security level, the authentication options applicable to the enterprise network are displayed.
 - **Personal**—On selecting the personal security level, the authentication options applicable to the personalized network are displayed.
 - **Open**—On selecting the open security level, the authentication options applicable to an open network are displayed.

The default security setting for a network profile is **Personal**.

4. Based on the security level selected, specify the following parameters.

Table 28: Configuration Parameters for WLAN Security Settings in an Employee or Voice Network

Parameter	Description	Security Level
<p>Key Management</p>	<p>Select the Enterprise security level, select any of the following options from the Key management drop-down list:</p> <ul style="list-style-type: none"> ■ WPA-2 Enterprise ■ WPA Enterprise (TKIP Encryption only) ■ WPA Enterprise (AES Encryption only) ■ Both (WPA-2 & WPA) ■ Dynamic WEP with 802.1X—If you do not want to use a session key from the RADIUS server to derive pairwise unicast keys, click the Use Session Key for LEAP check box. This is required for old printers that use dynamic WEP through LEAP authentication. The Use Session Key for LEAP feature is disabled by default. <p>For the Personal security level, select any of the following encryption keys from the Key management drop-down list.</p> <ul style="list-style-type: none"> ■ WPA-2 Personal ■ WPA-Personal (Both TKIP and AES Encryption) ■ WPA-Personal (TKIP Encryption only) ■ WPA-Personal (AES Encryption only) ■ Both (WPA-2 & WPA) ■ Static WEP <p>If a WPA-2, WPA encryption, or Both (WPA-2&WPA) is selected, configure the passphrase:</p> <ol style="list-style-type: none"> 1. Select a passphrase format from the Passphrase format drop-down list. The options available are 8–63 alphanumeric characters and 64 hexadecimal characters. 2. Enter a passphrase in the Passphrase text box. To reconfirm, update the passphrase in the Retype text box. <p>NOTE: The Passphrase may contain any special character except for ". For Static WEP, specify the following parameters:</p> <ol style="list-style-type: none"> 1. Select an appropriate value for WEP key size from the WEP key size drop-down list. You can specify 64-bit or 128-bit . 2. Select an appropriate value for Tx key from the Tx Key drop-down list. You can specify 1, 2, 3, or 4. 3. Enter an appropriate WEP key and reconfirm. 	<p>Applicable to Enterprise and Personal security levels only. For the Open security level, no encryption settings are required.</p>
<p>EAP Offload</p>	<p>To terminate the EAP portion of 802.1X authentication on the OAW-IAP instead of the RADIUS server, set EAP Offload to Enabled. Enabling EAP Offload can reduce network traffic to the external RADIUS server by terminating the authorization protocol on the OAW-IAP. By default, for 802.1X authorization, the client conducts an EAP exchange with the RADIUS server, and the OAW-IAP acts as a relay for this exchange.</p> <p>When EAP Offload is enabled, the OAW-IAP by itself acts as an authentication server and terminates the outer layers of the EAP protocol, only relaying the innermost layer to the external RADIUS server. It can also reduce the number of exchange packets between the OAW-IAP and the authentication server.</p> <p>NOTE: AOS-W Instant supports the configuration of primary and backup authentication servers in an EAP termination-enabled SSID. NOTE: If you are using LDAP for authentication, ensure that OAW-IAP termination is configured to support EAP.</p>	<p>Enterprise security level</p>
<p>Authentication server 1 and Authentication server 2</p>	<p>Select any of the following options from the Authentication server 1 drop-down list:</p> <ul style="list-style-type: none"> ■ Select an authentication server from the list if an external server is already configured. To modify the server parameters, click Edit. ■ Select New to add a new server. <p>For information on configuring external servers, see Configuring an</p>	<p>Enterprise, Personal, and Open security levels.</p>

Table 28: Configuration Parameters for WLAN Security Settings in an Employee or Voice Network

Parameter	Description	Security Level
	<p>External Server for Authentication on page 198.</p> <ul style="list-style-type: none"> To use an internal server, select Internal server and add the clients that are required to authenticate with the internal RADIUS server. Click the Users link to add the users. For information on adding a user, see Managing OAW-IAP Users on page 185. <p>If an external server is selected, you can also configure another authentication server.</p>	
Load balancing	<p>Set this to Enabled if you are using two RADIUS authentication servers, so that the load across the two RADIUS servers is balanced. For more information on the dynamic load balancing mechanism, see Dynamic Load Balancing between Two Authentication Servers on page 198.</p>	Enterprise, Personal, and Open security levels.
Reauth interval	<p>Specify a value for Reauth interval. When set to a value greater than zero, OAW-IAPs periodically reauthenticate all associated and authenticated clients.</p> <p>The following list provides descriptions for three reauthentication interval configuration scenarios:</p> <ul style="list-style-type: none"> When Reauth interval is configured on an SSID performing L2 authentication (MAC or 802.1X authentication)—When reauthentication fails, the clients are disconnected. If the SSID is performing only MAC authentication and has a pre-authentication role assigned to the client, the client will get a post-authentication role only after a successful reauthentication. If reauthentication fails, the client retains the pre-authentication role. When Reauth interval is configured on an SSID performing both L2 and L3 authentication (MAC with captive portal authentication)—When reauthentication succeeds, the client retains the role that is already assigned. If reauthentication fails, a pre-authentication role is assigned to the client. When Reauth interval is configured on an SSID performing only L3 authentication (captive portal authentication)—When reauthentication succeeds, a pre-authentication role is assigned to the client that is in a post-authentication role. Due to this, the clients are required to go through captive portal to regain access. 	Enterprise, Personal, and Open security levels.
Blacklisting	<p>To enable blacklisting of the clients with a specific number of authentication failures, select Enabled from the Blacklisting drop-down list and specify a value for Max auth failures. The users who fail to authenticate the number of times specified in Max authentication failures are dynamically blacklisted.</p>	Enterprise, Personal, and Open security levels.
Accounting	<p>Select any of the following options:</p> <ul style="list-style-type: none"> To enable accounting, select Use authentication servers from the Accounting drop-down list. On enabling the accounting function, OAW-IAPs post accounting information to the RADIUS server at the specified Accounting interval. To use a separate server for accounting, select Use separate servers. The accounting server is distinguished from the authentication server specified for the SSID profile. To disable the accounting function, select Disabled. 	Enterprise, Personal, and Open security levels.
Authentication survivability	<p>To enable authentication survivability, set Authentication survivability to Enabled. Specify a value in hours for Cache timeout (global) to set the duration after which the authenticated credentials in the cache must expire. When the cache expires, the clients are required to authenticate again. You can specify a value within a range of 1–99 hours and the default value is 24 hours.</p>	Enterprise security level

Table 28: Configuration Parameters for WLAN Security Settings in an Employee or Voice Network

Parameter	Description	Security Level
	<p>NOTE: The authentication survivability feature requires ClearPass Policy Manager 6.0.2 or later, and is available only when the New server option is selected. On setting this parameter to Enabled, AOS-W Instant authenticates the previously connected clients using EAP-PEAP authentication even when connectivity to ClearPass Policy Manager is temporarily lost. The Authentication survivability feature is not applicable when a RADIUS server is configured as an internal server.</p>	
<p>MAC authentication</p>	<p>To enable MAC-address-based authentication for Personal and Open security levels, set MAC authentication to Enabled. For Enterprise security level, the following options are available:</p> <ul style="list-style-type: none"> ■ Perform MAC authentication before 802.1X—Select this check box to use 802.1X authentication only when the MAC authentication is successful. ■ MAC authentication fail-thru—On selecting this check box, the 802.1X authentication is attempted when the MAC authentication fails. <p>NOTE: If Enterprise Security level is chosen, the server used for mac authentication will be the same as the server, defined for 802.1x authentication. You will not be able to use the OAW-IAPs internal database for mac authentication and external RADIUS server for 802.1x authentication on the same SSID.</p>	<p>Enterprise, Personal, and Open security levels.</p>
<p>Delimiter character</p>	<p>Specify a character (for example, colon or dash) as a delimiter for the MAC address string. When configured, the OAW-IAP will use the delimiter in the MAC authentication request. For example, if you specify colon as the delimiter, MAC addresses in the xx:xx:xx:xx:xx:xx format are used. If the delimiter is not specified, the MAC address in the xxxxxxxxxxxx format is used.</p> <p>NOTE: This option is available only when MAC authentication is enabled.</p>	<p>Enterprise, Personal, and Open security levels.</p>

Table 28: Configuration Parameters for WLAN Security Settings in an Employee or Voice Network

Parameter	Description	Security Level
Uppercase support	Set to Enabled to allow the OAW-IAP to use uppercase letters in MAC address string for MAC authentication. NOTE: This option is available only if MAC authentication is enabled.	Enterprise, Personal, and Open security levels.
Upload certificate	Click the Upload certificate link and browse to upload a certificate file for the internal server. For more information on certificates, see Uploading Certificates on page 235 .	Enterprise, Personal, and Open security levels
Fast Roaming	You can configure the following fast roaming options for the WLAN SSID: <ul style="list-style-type: none"> ■ Opportunistic Key Caching: You can enable Opportunistic Key Caching (OKC) when WPA-2 Enterprise and Both (WPA2 & WPA) encryption types are selected. If OKC is enabled, a cached PMK is used when the client roams to a new OAW-IAP. This allows faster roaming of clients without the need for a complete 802.1X authentication. ■ 802.11r: Selecting this check box enables fast BSS transition. The Fast BSS Transition mechanism minimizes the delay when a client transitions from one BSS to another within the same cluster. This option is available only when WPA-2 Enterprise and WPA-2 personal encryption keys are selected. ■ 802.11k: Selecting this check box enables 802.11k roaming on the SSID profile. The 802.11k protocol enables OAW-IAPs and clients to dynamically measure the available radio resources. When 802.11k is enabled, OAW-IAPs and clients send neighbor reports, beacon reports, and link measurement reports to each other. ■ 802.11v: Selecting this check box enables the 802.11v-based BSS transition. 802.11v standard defines mechanisms for wireless network management enhancements and BSS transition management. It allows client devices to exchange information about the network topology and RF environment. The BSS transition management mechanism enables an OAW-IAP to request a voice client to transition to a specific OAW-IAP, or suggest a set of preferred OAW-IAPs to a voice client, due to network load balancing or BSS termination. It also helps the voice client identify the best OAW-IAP to transition to as they roam. 	Enterprise, Personal, and Open security levels.

4. Click **Next** to configure access rules. For more information, see [Configuring Access Rules for a WLAN SSID Profile on page 121](#).

In the New WebUI

To configure security settings for an Employee or Voice network:

1. Navigate to the **Configuration > Networks** page.
2. Under **Networks** select the network you want to configure and click **Edit**.
3. Select **Security** tab. In the **Security Level** drop-down list box select one of the following levels:
 - **Enterprise**—On selecting the enterprise security level, the authentication options applicable to the enterprise network are displayed.
 - **Personal**—On selecting the personal security level, the authentication options applicable to the personalized network are displayed.
 - **Open**—On selecting the open security level, the authentication options applicable to an open network are displayed.

The default security setting for a network profile is **Personal**.

4. Based on the security level selected, specify the following parameters.

Table 29: Configuration Parameters for WLAN Security Settings in an Employee or Voice Network

Parameter	Description	Security Level
<p>Key Management</p>	<p>Click the Enterprise security level, select any of the following options from the Key management drop-down list:</p> <ul style="list-style-type: none"> ■ WPA-2 Enterprise ■ WPA Enterprise ■ Both (WPA-2 & WPA) ■ Dynamic WEP with 802.1X—If you do not want to use a session key from the RADIUS server to derive pairwise unicast keys, set Session Key for LEAP to Enabled. This is required for old printers that use dynamic WEP through LEAP authentication. The Session Key for LEAP feature is set to Disabled by default. <p>For the Personal security level, select any of the following encryption keys from the Key management drop-down list.</p> <ul style="list-style-type: none"> ■ WPA-2 Personal ■ WPA-Personal (Both TKIP and AES Encryption) ■ WPA-Personal (TKIP Encryption only) ■ WPA-Personal (AES Encryption only) ■ Both (WPA-2 & WPA) ■ Static WEP <p>If a WPA-2, WPA encryption, or Both (WPA-2&WPA) is selected, configure the passphrase:</p> <ol style="list-style-type: none"> 1. Select a passphrase format from the Passphrase format drop-down list. The options available are 8–63 alphanumeric characters and 64 hexadecimal characters. 2. Enter a passphrase in the Passphrase text box. To reconfirm, update the passphrase in the Retype text box. <p>NOTE: The Passphrase may contain any special character except for ".".</p> <p>For Static WEP, specify the following parameters:</p> <ol style="list-style-type: none"> 1. Select an appropriate value for WEP key size from the WEP key size drop-down list. You can specify 64-bit or 128-bit . 2. Select an appropriate value for Tx key from the Tx Key drop-down list. You can specify 1, 2, 3, or 4. 3. Enter an appropriate WEP key and reconfirm. 	<p>Applicable to Enterprise and Personal security levels only.</p> <p>For the Open security level, no encryption settings are required.</p>
<p>EAP Offload</p>	<p>To terminate the EAP portion of 802.1X authentication on the OAW-IAP instead of the RADIUS server, click the EAP Offload toggle switch. Enabling termination can reduce network traffic to the external RADIUS server by terminating the authorization protocol on the OAW-IAP. By default, for 802.1X authorization, the client conducts an EAP exchange with the RADIUS server, and the OAW-IAP acts as a relay for this exchange.</p> <p>When EAP Offload is enabled, the OAW-IAP by itself acts as an authentication server and terminates the outer layers of the EAP protocol, only relaying the innermost layer to the external RADIUS server. It can also reduce the number of exchange packets between the OAW-IAP and the authentication server.</p> <p>NOTE: AOS-W Instant supports the configuration of primary and backup authentication servers in an EAP termination-enabled SSID.</p> <p>NOTE: If you are using LDAP for authentication, ensure that OAW-IAP termination is configured to support EAP.</p>	<p>Enterprise security level</p>
<p>Authentication server 1 and Authentication server 2</p>	<p>Select any of the following options from the Authentication server 1 drop-down list:</p> <ul style="list-style-type: none"> ■ Select an authentication server from the list if an external server is already configured. To modify the server parameters, click the edit icon. ■ Select + to add a new server. <p>For information on configuring external servers, see Configuring an External Server for Authentication on page 198.</p>	<p>Enterprise, Personal, and Open security levels.</p>

Table 29: Configuration Parameters for WLAN Security Settings in an Employee or Voice Network

Parameter	Description	Security Level
	<ul style="list-style-type: none"> To use an internal server, select InternalServer and add the clients that are required to authenticate with the internal RADIUS server. If an external server is selected, you can also configure another authentication server. 	
Load balancing	Click the toggle switch if you are using two RADIUS authentication servers, so that the load across the two RADIUS servers is balanced. For more information on the dynamic load balancing mechanism, see Dynamic Load Balancing between Two Authentication Servers on page 198 .	Enterprise, Personal, and Open security levels.
Reauth interval	Specify a value for Reauth interval . When set to a value greater than zero, OAW-IAPs periodically reauthenticate all associated and authenticated clients. The following list provides descriptions for three reauthentication interval configuration scenarios: <ul style="list-style-type: none"> When Reauth interval is configured on an SSID performing L2 authentication (MAC or 802.1X authentication)—When reauthentication fails, the clients are disconnected. If the SSID is performing only MAC authentication and has a pre-authentication role assigned to the client, the client will get a post-authentication role only after a successful reauthentication. If reauthentication fails, the client retains the pre-authentication role. When Reauth interval is configured on an SSID performing both L2 and L3 authentication (MAC with captive portal authentication)—When reauthentication succeeds, the client retains the role that is already assigned. If reauthentication fails, a pre-authentication role is assigned to the client. When Reauth interval is configured on an SSID performing only L3 authentication (captive portal authentication)—When reauthentication succeeds, a pre-authentication role is assigned to the client that is in a post-authentication role. Due to this, the clients are required to go through captive portal to regain access. 	Enterprise, Personal, and Open security levels.
Blacklisting	To enable blacklisting of the clients with a specific number of authentication failures, Click the Blacklisting toggle switch and specify a value for Max authentication failures . The users who fail to authenticate the number of times specified in Max authentication failures are dynamically blacklisted.	Enterprise, Personal, and Open security levels.
Accounting	Select any of the following options: <ul style="list-style-type: none"> To enable accounting, select Use authentication servers from the Accounting drop-down list. On enabling the accounting function, OAW-IAPs post accounting information to the RADIUS server at the specified Accounting interval. To use a separate server for accounting, select Use separate servers. The accounting server is distinguished from the authentication server specified for the SSID profile. To disable the accounting function, select Disabled. 	Enterprise, Personal, and Open security levels.
Authentication survivability	To enable authentication survivability, click the Authentication survivability toggle switch. Specify a value in hours for Cache timeout (global) to set the duration after which the authenticated credentials in the cache must expire. When the cache expires, the clients are required to authenticate again. You can specify a value within a range of 1–99 hours and the default value is 24 hours. NOTE: The authentication survivability feature requires ClearPass Policy Manager 6.0.2 or later, and is available only when the New server option is selected. On setting this parameter to Enabled , AOS-W Instant	Enterprise security level

Table 29: Configuration Parameters for WLAN Security Settings in an Employee or Voice Network

Parameter	Description	Security Level
	authenticates the previously connected clients using EAP-PEAP authentication even when connectivity to ClearPass Policy Manager is temporarily lost. The Authentication survivability feature is not applicable when a RADIUS server is configured as an internal server.	
MAC authentication	To enable MAC-address-based authentication for Personal and Open security levels, enable the MAC authentication toggle switch. For Enterprise security level, the following options are available: <ul style="list-style-type: none">■ Perform MAC authentication before 802.1X—Select this check box to use 802.1X authentication only when the MAC authentication is successful.■ MAC authentication fail-thru—On selecting this check box, the 802.1X authentication is attempted when the MAC authentication fails. NOTE: If Enterprise Security level is chosen, the server used for mac authentication will be the same as the server, defined for 802.1x authentication. You will not be able to use the OAW-IAPs internal database for mac authentication and external RADIUS server for 802.1x authentication on the same SSID.	Enterprise, Personal, and Open security levels.
Delimiter character	Specify a character (for example, colon or dash) as a delimiter for the MAC address string. When configured, the OAW-IAP will use the delimiter in the MAC authentication request. For example, if you specify colon as the delimiter, MAC addresses in the xx:xx:xx:xx:xx:xx format are used. If the delimiter is not specified, the MAC address in the xxxxxxxxxxxx format is used. NOTE: This option is available only when MAC authentication is enabled.	Enterprise, Personal, and Open security levels.

Table 29: Configuration Parameters for WLAN Security Settings in an Employee or Voice Network

Parameter	Description	Security Level
Uppercase support	Click the toggle switch to allow the OAW-IAP to use uppercase letters in MAC address string for MAC authentication. NOTE: This parameter is available only when MAC authentication is enabled.	Enterprise, Personal, and Open security levels.
Upload Certificate	Click Upload Certificate and browse to upload a certificate file for the internal server. For more information on certificates, see Uploading Certificates on page 235 .	Enterprise, Personal, and Open security levels
Fast Roaming	You can configure the following fast roaming options for the WLAN SSID: <ul style="list-style-type: none"> ■ Opportunistic Key Caching: You can enable Opportunistic Key Caching (OKC) when WPA-2 Enterprise and Both (WPA2 & WPA) encryption types are selected. If OKC is enabled, a cached PMK is used when the client roams to a new OAW-IAP. This allows faster roaming of clients without the need for a complete 802.1X authentication. ■ 802.11r: Selecting this check box enables fast BSS transition. The Fast BSS Transition mechanism minimizes the delay when a client transitions from one BSS to another within the same cluster. This option is available only when WPA-2 Enterprise and WPA-2 personal encryption keys are selected. ■ 802.11k: Selecting this check box enables 802.11k roaming on the SSID profile. The 802.11k protocol enables OAW-IAPs and clients to dynamically measure the available radio resources. When 802.11k is enabled, OAW-IAPs and clients send neighbor reports, beacon reports, and link measurement reports to each other. ■ 802.11v: Selecting this check box enables the 802.11v-based BSS transition. 802.11v standard defines mechanisms for wireless network management enhancements and BSS transition management. It allows client devices to exchange information about the network topology and RF environment. The BSS transition management mechanism enables an OAW-IAP to request a voice client to transition to a specific OAW-IAP, or suggest a set of preferred OAW-IAPs to a voice client, due to network load balancing or BSS termination. It also helps the voice client identify the best OAW-IAP to transition to as they roam. 	Enterprise, Personal, and Open security levels.

4. Click **Next** to configure access rules. For more information, see [Configuring Access Rules for a WLAN SSID Profile on page 121](#).

In the CLI

To configure enterprise security settings for the Employee and Voice users:

```
(Instant AP) (config)# wlan ssid-profile <name>
(Instant AP) (SSID Profile <name>)# opmode {wpa2-aes|wpa-tkip,wpa2-aes|dynamic-wep}
(Instant AP) (SSID Profile <name>)# leap-use-session-key
(Instant AP) (SSID Profile <name>)# termination
(Instant AP) (SSID Profile <name>)# auth-server <server-name>
(Instant AP) (SSID Profile <name>)# external-server
(Instant AP) (SSID Profile <name>)# server-load-balancing
(Instant AP) (SSID Profile <name>)# blacklist
(Instant AP) (SSID Profile <name>)# mac-authentication
(Instant AP) (SSID Profile <name>)# l2-auth-failthrough
(Instant AP) (SSID Profile <name>)# auth-survivability
(Instant AP) (SSID Profile <name>)# radius-accounting
(Instant AP) (SSID Profile <name>)# radius-accounting-mode {user-association|user-authentication}
(Instant AP) (SSID Profile <name>)# radius-interim-accounting-interval <minutes>
(Instant AP) (SSID Profile <name>)# radius-reauth-interval <minutes>
(Instant AP) (SSID Profile <name>)# max-authentication-failures <number>
```

```
(Instant AP) (SSID Profile <name>)# okc
(Instant AP) (SSID Profile <name>)# dot11r
(Instant AP) (SSID Profile <name>)# dot11k
(Instant AP) (SSID Profile <name>)# dot11v
(Instant AP) (SSID Profile <name>)# exit
(Instant AP) (config)# auth-survivability cache-time-out
```

To configure personal security settings for the Employee and Voice users:

```
(Instant AP) (config)# wlan ssid-profile <name>
(Instant AP) (SSID Profile <name>)# opmode {wpa2-psk-aes|wpa-tkip|wpa-psk-tkip|wpa-psk-tkip,wpa2-psk-aes|static-wep|mpsk-aes}
(Instant AP) (SSID Profile <name>)# mac-authentication
(Instant AP) (SSID Profile <name>)# auth-server <server-name>
(Instant AP) (SSID Profile <name>)# external-server
(Instant AP) (SSID Profile <name>)# server-load-balancing
(Instant AP) (SSID Profile <name>)# blacklist
(Instant AP) (SSID Profile <name>)# max-authentication-failures <number>
(Instant AP) (SSID Profile <name>)# radius-accounting
(Instant AP) (SSID Profile <name>)# radius-accounting-mode {user-association|user-authentication}
(Instant AP) (SSID Profile <name>)# radius-interim-accounting-interval <minutes>
(Instant AP) (SSID Profile <name>)# radius-reauth-interval <minutes>
```

To configure open security settings for Employee and Voice users of a WLAN SSID profile:

```
(Instant AP) (config)# wlan ssid-profile <name>
(Instant AP) (SSID Profile <name>)# opmode opensystem
(Instant AP) (SSID Profile <name>)# mac-authentication
(Instant AP) (SSID Profile <name>)# auth-server <server-name>
(Instant AP) (SSID Profile <name>)# external-server
(Instant AP) (SSID Profile <name>)# server-load-balancing
(Instant AP) (SSID Profile <name>)# blacklist
(Instant AP) (SSID Profile <name>)# max-authentication-failures <number>
(Instant AP) (SSID Profile <name>)# radius-accounting
(Instant AP) (SSID Profile <name>)# radius-accounting-mode {user-association|user-authentication}
(Instant AP) (SSID Profile <name>)# radius-interim-accounting-interval <minutes>
(Instant AP) (SSID Profile <name>)# radius-reauth-interval <minutes>
```

Configuring Multiple PSK For WLAN SSID Profiles

WPA2 PSK-based deployments generally consist of a single passphrase configured as part of the WLAN SSID profile. This single passphrase is applicable for all clients that associate with the SSID. Starting from Alcatel-Lucent AOS-W Instant 8.4.0.0, multiple PSKs in conjunction with ClearPass Policy Manager are supported for WPA and WPA2 PSK-based deployments. Every client connected to the WLAN SSID will have its own unique PSK.

MPSK enhances the WPA2 PSK mode by allowing device-specific or group-specific passphrases, which are generated at ClearPass Policy Manager and sent to the OAW-IAP.

A MPSK passphrase requires MAC authentication against a ClearPass Policy Manager server. The MPSK passphrase works only with wpa2-psk-aes encryption and not with any other PSK based encryption. The Aruba-MPSK-Passphrase radius VSA is added and the ClearPass Policy Manager server populates this VSA with the encrypted passphrase for the device.

A user registers the device on a ClearPass Policy Manager guest-registration or device-registration webpage and receives a device-specific or group-specific passphrase. The device associates with the SSID using wpa2-psk-aes encryption and uses MPSK passphrase. The OAW-IAP performs MAC authentication of the client against the ClearPass Policy Manager server. On successful MAC authentication, the ClearPass Policy Manager returns Access-Accept with the VSA containing the encrypted passphrase. The OAW-IAP generates a PSK from the passphrase and performs 4-way key exchange. If the device uses the correct per-device or per-group

passphrase, authentication succeeds. If the ClearPass Policy Manager server returns Access-Reject or the client uses incorrect passphrase, authentication fails.



When multiple PSK is enabled on the WLAN SSID profile, make sure that MAC authentication is not configured for RADIUS authentication. Multiple PSK and MAC authentication are mutually exclusive and follows a special procedure which does not require enabling MAC authentication in the WLAN SSID manually. Also, ensure that the RADIUS server configured for the WLAN SSID profile is not an internal server.

Currently, the multiple PSK feature can be enabled on the OAW-IAP only through the AOS-W Instant CLI. The following configuration enables the multiple PSK feature on the WLAN SSID profile:

```
(Instant AP) (configure)# wlan ssid-profile <profile_name>
(Instant AP) (SSID Profile <profile_name>)# opmode mpsk-aes
```

Execute the following command to verify the status of the MPSK configuration on the WLAN SSID profile:

```
(Instant AP)# show network <ssid profile name>
```

Points to Remember

The following configurations are mutually exclusive with MPSK for the WLAN SSID profile and does not require to be configured manually:

- MPSK and MAC authentication
- MPSK and Blacklisting
- MPSK and internal RADIUS server

MPSK Cache

The OAW-IAP stores the MPSK passphrase in its local cache for client roaming. The cache is shared between all the OAW-IAPs within a single cluster. The cache can also be shared with standalone OAW-IAPs in a different cluster provided the APs belong to the same multicast VLAN. Each OAW-IAP will first search the local cache for the MPSK information. If the local cache has the corresponding mPSK passphrase, the OAW-IAP skips the mac authentication procedure, and provides access to the client. If the MPSK passphrase is not found in the local cache, you must manually configure the MPSK passphrase as shown in the above section.

The cached MPSK passphrase can be used only if the client connects to the same WLAN SSID. The entire MPSK local cache is erased in the following scenarios:

- If the cached MPSK does not work.
- The client is manually disconnected
- The client is disconnected from the CoA.



The MPSK passphrase in the local cache automatically expires if the client disconnects and does not connect again during the inactivity-timeout window.

To view the details of the MPSK local cache:

```
(Instant AP)# show ap mpskcache
```

Configuring Access Rules for a WLAN SSID Profile

This section describes the procedure for configuring security settings for Employee and Voice networks only. For information on guest network configuration, see [Captive Portal for Guest Access](#).



If you are creating a new SSID profile, complete the WLAN settings and configure VLAN and security parameters, before defining access rules. For more information, see [Configuring WLAN Settings for an SSID Profile on page 101](#), [Configuring VLAN Settings for a WLAN SSID Profile on page 108](#), and [Configuring Security Settings for a WLAN SSID Profile on page 111](#).

You can configure up to 128 access rules for an Employee, Voice , or Guest network using the AOS-W Instant UI or the CLI.

In the Old WebUI

To configure access rules for an Employee or Voice network:

1. In the **Networks** tab, select the network to configure and click **edit**.
2. Select the **Access** tab
3. Specify any of the following types of security levels by moving the slider to a desired level:
 - **Unrestricted**—Select this option to set unrestricted access to the network.
 - **Network-based**—Select this option to set common rules for all users in a network. The **Allow any to all destinations** access rule is enabled by default. This rule allows traffic to all destinations.

To define an access rule:

- a. Click **New**.
 - b. Select appropriate options in the **New Rule** window.
 - c. Click **OK**.
- **Role-based**—Select this option to enable access based on user roles. For role-based access control:
 - Create a user role if required. For more information, see [Configuring User Roles](#).
 - Create access rules for a specific user role. For more information, see [Configuring ACL Rules for Network Services on page 240](#). You can also configure an access rule to enforce captive portal authentication for an SSID that is configured to use 802.1X authentication method. For more information, see [Configuring Captive Portal Roles for an SSID on page 179](#).
 - Create a role assignment rule. For more information, see [Configuring Derivation Rules on page 264](#).
 - **Enforce Machine Authentication**— Select this check box to configure access rights to clients based on whether the client device supports machine authentication.
4. Click **Finish**.

In the New WebUI

To configure access rules for an Employee or Voice network:

1. Navigate to the **Configuration > Networks** page.
2. Under **Networks** select the network you want to configure and click **Edit**.
3. Select **Access** tab. In the **Access Rules** drop-down list box select one of the following type:
 - **Unrestricted**—Select this option to set unrestricted access to the network.
 - **Network-based**—Select this option to set common rules for all users in a network. The **Allow any to all destinations** access rule is enabled by default. This rule allows traffic to all destinations.

To define an access rule:

- a. Click **+**.
 - b. Select appropriate options in the **New Rule** window.
 - c. Click **OK**.
- **Role-based**—Select this option to enable access based on user roles. For role-based access control:
 - To create a user role click **+** in the **Roles** window. For more information, see [Configuring User Roles](#).
 - Create access rules for a specific user role. For more information, see [Configuring ACL Rules for Network Services on page 240](#). You can also configure an access rule to enforce captive portal

authentication for an SSID that is configured to use 802.1X authentication method. For more information, see [Configuring Captive Portal Roles for an SSID on page 179](#).

- To create a role assignment rule, click **+** in the **Role Assignment Rules** window. For more information, see [Configuring Derivation Rules on page 264](#).
 - **Enforce Machine Authentication**— Enable this toggle switch to configure access rights to clients based on whether the client device supports machine authentication.
4. Click **Finish**.

In the CLI

To configure access control rules for a WLAN SSID:

```
(Instant AP) (config)# wlan access-rule <name>
(Instant AP) (Access Rule <name>)# rule <dest> <mask> <match> {<protocol> <start-port> <end-port> {permit|deny|src-nat [vlan <vlan_id>|tunnel]|dst-nat{<IP-address> <port>|<port>}}| app <app> {permit|deny}| appcategory <appgrp>|webcategory <webgrp> {permit|deny}| webreputation <webrep> [<option1...option9>]
```

To configure access control rules based on the SSID:

```
(Instant AP) (config)# wlan ssid-profile <name>
(Instant AP) (SSID Profile <name>)# set-role-by-ssid
```

To configure role assignment rules:

```
(Instant AP) (config)# wlan ssid-profile <name>
(Instant AP) (SSID Profile <name>)# set-role <attribute>{{equals|not-equals|starts-with|ends-with|contains|matches-regular-expression}<operator><role>|value-of}
```

To configure a pre-authentication role:

```
(Instant AP) (config)# wlan ssid-profile <name>
(Instant AP) (SSID Profile <name>)# set-role-pre-auth <role>
```

To configure machine and user authentication roles:

```
(Instant AP) (config)# wlan ssid-profile <name>
(Instant AP) (SSID Profile <name>)# set-role-machine-auth <machine_only> <user_only>
```

To configure unrestricted access:

```
(Instant AP) (config)# wlan ssid-profile <name>
(Instant AP) (SSID Profile <name>)# set-role-unrestricted
```

Example

The following example configures access rules for the wireless network:

```
(Instant AP) (config)# wlan access-rule WirelessRule
```

SSID and VLAN Configuration

Starting from AOS-W Instant 6.4.4.4-4.2.3.0, you can set a unique SSID and also configure a unique a VLAN for each OAW-IAP in a cluster. Clients will be able to connect to the defined SSIDs and can configure the defined VLANs in the OAW-IAP cluster.

You can configure the SSID and VLAN settings by using the AOS-W Instant CLI.

In the CLI

The following command is used to configure SSID and VLAN settings in a WLAN profile:

```
(Instant AP) (config)# wlan ssid-profile TechPubsAP
(Instant AP) (SSID Profile "TechPubsAP")# essid $per-ap-ssid
(Instant AP) (SSID Profile "TechPubsAP")# vlan $per-ap-vlan
```

To configure SSID settings:

```
(Instant AP)# per-ap-ssid pcap
```

To configure VLAN settings:

```
(Instant AP)# per-ap-vlan 123
```

To verify the SSID and VLAN configurations:

```
(Instant AP)# show ap-env
Antenna Type:Internal
Need USB field:Yes
per_ap_ssid:pcap
per_ap_vlan:123
installation_type:indoor
uap_controller_less:1
flex_radio_mode:2.4ghz
ap2xx_prestandard_poeplus_detection:1
```



For information on configuring a native VLAN on a wired profile, see [Configuring VLAN for a Wired Profile on page 136](#).

Configuring Fast Roaming for Wireless Clients

AOS-W Instant supports the following features that enable fast roaming of clients:

- [OKC](#)
- [Fast BSS Transition \(802.11r Roaming\)](#)
- [Radio Resource Management \(802.11k\)](#)
- [BSS Transition Management \(802.11v\)](#)

OKC

AOS-W Instant now supports OKC-based roaming. In OKC-based roaming, the OAW-IAP stores one PMK per client, which is derived from the last 802.1X authentication completed by the client in the network. The cached PMK is used when a client roams to a new OAW-IAP. This allows faster roaming of clients between the OAW-IAPs in a cluster, without requiring a complete 802.1X authentication.



OKC roaming (when configured in the 802.1X Authentication profile) is supported on WPA-2 clients. If the wireless client (the 802.1X supplicant) does not support this feature, a complete 802.1X authentication is required whenever a client roams to a new OAW-IAP.

Configuring an OAW-IAP for OKC Roaming

You can enable OKC roaming for WLAN SSID by using the AOS-W Instant WebUI or the CLI.

In the Old WebUI

1. In the **Networks** tab, select the WLAN SSID you want to configure and click **edit**.
2. Select the **Security** tab.
3. Move the security level slider to **Enterprise**.
4. Select the **WPA-2 Enterprise** or **Both (WPA-2 & WPA)** option from the **Key management** drop-down list.
5. Under **Fast Roaming** select the **Opportunistic Key Caching (OKC)** checkbox to enable OKC.
6. Click **Next** and then **Finish**.

In the New WebUI

1. Navigate to the **Configuration > Networks** page.
2. Under **Networks** select the WLAN SSID you want to configure and click **Edit**.

3. Select the **Security** tab.
4. In the **Security Level** drop-down list box, select **Enterprise**.
5. In the **Key management** drop-down list box, select **WPA-2 Enterprise** or **Both (WPA-2 & WPA)**.
6. Under **Fast Roaming**, toggle the **Opportunistic Key Caching (OKC)** switch to enable.
7. Click **Next** and then **Finish**.

In the CLI

To enable OKC roaming on a WLAN SSID:

```
(Instant AP) (config)# wlan ssid-profile <name>
(Instant AP) (SSID Profile "<name>")# opmode {wpa2-aes| wpa-tkip,wpa-aes,wpa2-tkip,wpa2-aes}
(Instant AP) (SSID Profile "<name>")# okc
```

To disable OKC roaming on a WLAN SSID:

```
(Instant AP) (config)# wlan ssid-profile <name>
(Instant AP) (SSID Profile "<name>")# opmode {wpa2-aes|wpa-tkip,wpa-aes,wpa2-tkip,wpa2-aes}
(Instant AP) (SSID Profile "<name>")# no okc
```

Fast BSS Transition (802.11r Roaming)

802.11r is a roaming standard defined by IEEE. When enabled, 802.11r reduces roaming delay by pre-authenticating clients with multiple target OAW-IAPs before a client roams to an OAW-IAP. With 802.11r implementation, clients pre-authenticate with multiple OAW-IAPs in a cluster.

As part of the 802.11r implementation, AOS-W Instant supports the Fast BSS Transition protocol. The Fast BSS Transition mechanism reduces client roaming delay when a client transitions from one BSS to another within the same cluster. This minimizes the time required to resume data connectivity when a BSS transition happens.



Fast BSS Transition is operational only if the wireless client supports 802.11r standard. If the client does not support 802.11r standard, it falls back to the normal WPA-2 authentication method.

Configuring an OAW-IAP for 802.11r support

You can configure 802.11r support for a WLAN SSID by using the AOS-W Instant UI or the CLI.

In the Old WebUI

1. In the **Networks** tab, select the WLAN SSID you want to configure and click **edit**.
2. Select the **Security** tab.
3. Under **Fast Roaming**, select the **802.11r** check box.
4. Click **Next** and then **Finish**.

In the New WebUI

1. Navigate to the **Configuration > Networks** page.
2. Under **Networks** select the WLAN SSID you want to configure and click **Edit**.
3. Select the **Security** tab.
4. Under **Fast Roaming**, toggle the **802.11r** switch to enable.
5. Click **Next** and then **Finish**.

In the CLI

To enable 802.11r roaming on a WLAN SSID:

```
(Instant AP) (config)# wlan ssid-profile <name>
(Instant AP) (SSID Profile <name>)# dot11r
```

Example

```
(Instant AP) (config)# wlan ssid-profile dot11r-profile  
(Instant AP) (SSID Profile "dot11r-profile")# dot11r
```

Mobility Domain Identifier

In a network of standalone OAW-IAPs within the same management VLAN, 802.11r roaming does not work. This is because the mobility domain identifiers do not match across OAW-IAPs. They are auto-generated based on a virtual switch key. AOS-W Instant introduces an option for users to set a mobility domain identifier for 802.11r SSIDs. For standalone OAW-IAPs in the same management VLAN, 802.11r roaming works only when the mobility domain identifier is configured with the same value.

You can configure a mobility domain identifier by using the AOS-W Instant WebUI or the CLI.

In the Old WebUI

1. In the **Networks** tab, select the WLAN SSID you want to configure and click **edit**.
2. Select the **Security** tab.
3. Under **Fast Roaming**, select the **802.11r** check box.
4. In the **MDID** text box enter the mobility domain identifier.
5. Click **Next** and then **Finish**.

In the New WebUI

1. Navigate to the **Configuration > Networks** page.
2. Under **Networks** select the WLAN SSID you want to configure and click **Edit**.
3. Select the **Security** tab.
4. Under **Fast Roaming**, toggle the **802.11r** switch to enable.
5. In the **MDID** text box, enter the mobility domain identifier.
6. Click **Next** and then **Finish**.

In the AOS-W Instant CLI

To enable MDID on a WLAN SSID:

```
(Instant AP) (config)# wlan ssid-profile <name>  
(Instant AP) (SSID Profile <name>)# mdid <Mobility domain ID>
```

Radio Resource Management (802.11k)

The 802.11k standard provides mechanisms for OAW-IAPs and clients to dynamically measure the available radio resources and enables stations to query and manage their radio resources. In an 802.11k-enabled network, OAW-IAPs and clients can share radio and link measurement information, neighbor reports, and beacon reports with each other. This allows the WLAN network infrastructural elements and clients to assess resources and make optimal mobility decisions to ensure QoS and seamless continuity.

AOS-W Instant supports the following radio resource management information elements with 802.11k support enabled:

- **Power Constraint IE**—The power constraint element contains the information necessary to allow a client to determine the local maximum transmit power in the current channel.
- **AP Channel Report IE**—The OAW-IAP channel report element contains a list of channels in a regulatory class where a client is likely to find an OAW-IAP, including the OAW-IAP transmitting the OAW-IAP channel report.
- **Radio Resource Management Enabled Capabilities IE**—The RRM-enabled capabilities element signals support for radio measurements in a device. The clients use this IE to specify their radio measurement capabilities.

- **BSS Load Element**—The BSS load element contains information on the density of clients and traffic levels in the QBSS.
- **TPC Report IE**—The TPC IE contains transmit power and link margin information.
- **Quiet IE**: The Quiet IE defines an interval during which no transmission occurs in the current channel. This interval may be used to assist in making channel measurements without interference from other stations in the BSS.
- **Extended Capabilities IE**—The extended capabilities IE carries information about the capabilities of an IEEE 802.11 station.

Beacon Report Requests and Probe Responses

The beacon request frame is sent by an OAW-IAP to request a client to report the list of beacons detected by the client on all channels.

- The beacon request is sent using the radio measurement request action frame.
- It is sent only to those clients that have the capability to generate beacon reports. The clients indicate their capabilities through the *RRM enabled capabilities IE* sent in the association request frames.
- By default, the beacon request frames are sent at a periodicity of 60 seconds.

Configuring a WLAN SSID for 802.11k Support

You can enable 802.11k support on a WLAN SSID by using the AOS-W Instant WebUI or the CLI.

In the Old WebUI

1. In the **Networks** tab, select the WLAN SSID you want to configure and click **edit**.
2. Select the **Security** tab.
3. Under **Fast Roaming**, select the **802.11k** check box.
4. Click **Next** and then **Finish**.



To allow the OAW-IAP and clients to exchange neighbor reports, ensure that Client Match is enabled through **RF > ARM > Client match > Enabled** in the WebUI or by executing the **client-match** command in the **arm** configuration sub-command mode.

In the New WebUI

1. Navigate to the **Configuration > Networks** page.
2. Under **Networks** select the WLAN SSID you want to configure and click **Edit**.
3. Select the **Security** tab.
4. Under **Fast Roaming**, toggle the **802.11k** to enable.
5. Click **Next** and then **Finish**.



To allow the OAW-IAP and clients to exchange neighbor reports, ensure that Client Match is enabled through **Configuration > RF > ARM > Client match** and enable the toggle switch in the webUI or by executing the **client-match** command in the **arm** configuration sub-command mode.

In the CLI

To enable 802.11k profile:

```
(Instant AP) (config)# wlan ssid-profile <name>
(Instant AP) (SSID Profile <name>)# dot11k
```

To view the beacon report details:

```
(Instant AP)# show ap dot11k-beacon-report <mac>
```

To view the neighbor details:

```
(Instant AP)# show ap dot11k-nbrs
```

Example

```
(Instant AP)(config)# wlan ssid-profile dot11k-profile  
(Instant AP)(SSID Profile "dot11k-profile")# dot11k
```

BSS Transition Management (802.11v)

The 802.11v standard provides Wireless Network Management enhancements to the IEEE 802.11 MAC and PHY. It extends radio measurements to define mechanisms for wireless network management of stations including BSS transition management.

OAW-IAPs support the generation of the BSS transition management request frames to the 802.11k clients when a suitable OAW-IAP is identified for a client through Client Match.

Configuring a WLAN SSID for 802.11v Support

You can enable 802.11v support on a WLAN SSID by using the AOS-W Instant UI or the CLI.

In the Old WebUI

1. In the **Networks** tab, select the WLAN SSID you want to configure and click **edit**.
2. Select the **Security** tab.
3. Under **Fast Roaming**, select the **802.11v** check box.
4. Click **Next** and then **Finish**.

In the New WebUI

1. Navigate to the **Configuration > Networks** page.
2. Under **Networks** select the WLAN SSID you want to configure and click **Edit**.
3. Select the **Security** tab.
4. Under **Fast Roaming**, toggle the **802.11v** to enable.
5. Click **Next** and then **Finish**.

In the CLI

To enable 802.11v profile:

```
(Instant AP)(config)# wlan ssid-profile <name>  
(Instant AP)(SSID Profile <name>)# dot11v
```

Example

```
(Instant AP)(config)# wlan ssid-profile dot11v-profile  
(Instant AP)(SSID Profile "dot11v-profile")# dot11v
```

Configuring Modulation Rates on a WLAN SSID

OAW-IAPs allow you to enable or disable modulation rates for a radio band; HT MCS set; and VHT MCS rates set, when configuring a WLAN SSID profile. For example, the 802.11g band supports the modulation rate including 1, 2, 5, 6, 9, 11, 12, 18, 24, 36, 48, 54 Mbps and 802.11a band supports a modulation rate set including 6, 9, 12, 18, 24, 36, 48, 54 Mbps.

The 802.11 radio profiles support basic modulation and transmission rates. The 802.11g basic modulation rates determine the 802.11b or 802.11g rates for the data that are advertised in beacon frames and probe response and 802.11g transmission rates determine the 802.11b or 802.11g rates at which the OAW-IAP can transmit data.

For 802.11n clients, you can now configure an HT MCS rate set so that the SSID does not broadcast the disabled MCS rates list.

For 802.11ac clients, only 10 MCS rates supported in the 802.11ac mode and OAW-IAPs use a combination of VHT MCSs and spatial streams to convey the supported MCS rates.

In the AOS-W Instant 6.4.3.4-4.2.1.0 release, the modulation rates can be configured only through the OAW-IAP CLI.

To configure modulation rates:

```
(Instant AP)# config terminal
(Instant AP)(config)# wlan ssid-profile <ssid_profile>
(Instant AP)(SSID Profile "<ssid_profile>")# a-basic-rates 6 9 12 18
(Instant AP)(SSID Profile "<ssid_profile>")# a-tx-rates 36 48 54
(Instant AP)(SSID Profile "<ssid_profile>")# supported-mcs-set 1,3,6,7
(Instant AP)(SSID Profile "<ssid_profile>")# vht-support-mcs-map 7, 9, 8
```

Multi-User-MIMO

The MU-MIMO feature allows the 802.11ac Wave 2 OAW-IAPs to send multiple frames to multiple clients simultaneously over the same frequency spectrum. With MU-MIMO, OAW-IAPs can support simultaneous directional RF links and up to four simultaneous full-rate Wi-Fi connections (for example, smart phone, tablet, laptop, multimedia player, or other client device).

The MU-MIMO feature is enabled by default on WLAN SSIDs to allow OAW-IAPs to use the MU beamformer bit in beacon frames to broadcast to clients. When disabled, the MU beamformer bit is set to unsupported.

Enabling or Disabling MU-MIMO

The MU-MIMO feature is enabled by default on WLAN SSIDs. To disable this feature:

```
(host)(config)# wlan ssid-profile <ssid_profile>
(host)(SSID Profile "<ssid_profile>")# vht-mu-txbf-disable
```

To re-enable MU-MIMO:

```
(host)(config)# wlan ssid-profile <ssid_profile>
(host)(SSID Profile "<ssid_profile>")# no vht-mu-txbf-disable
```

RTS/CTS Flow Control

The RTS/CTS mechanism allows devices to reserve the RF medium and minimize the frame collisions introduced by hidden stations. When RTS is enabled, a higher number of retransmissions occurring on the WLAN triggers the RTS/CTS handshake and the transmitter station sends an RTS frame to the receiver station. The receiver station responds with a CTS frame. The RTS/CTS frames are sent only when the packet size exceeds the RTS threshold. By default, the RTS threshold is set to 2333 octets.

Configuring RTS/CTS Threshold

You can set the RTS/CTS threshold value within the range of 0–2347 octets. By default, the RTS/CTS threshold is set to 2333.

To configure the RTS/CTS threshold:

```
(Instant AP)(config)# wlan ssid-profile <ssid_profile>
(Instant AP)(SSID Profile "<ssid_profile>")# rts-threshold <threshold>
```

To disable RTS/CTS, set the RTS threshold value to 0.

Management Frame Protection

AOS-W Instant supports the IEEE 802.11w standard, also known as Management Frame Protection. The Management Frame Protection increases the security by providing data confidentiality of management frames. Management Frame Protection uses 802.11i framework that establishes encryption keys between the client and OAW-IAP.

To enable Management Frame Protection on the OAW-IAP:

```
(Instant AP) (config)# wlan ssid-profile myAP
(Instant AP) (SSID Profile "myAP")# mfp-capable
(Instant AP) (SSID Profile "myAP")# mfp-required
```

If the *mfp-required* parameter is enabled, the SSID supports only the clients that exhibit the Management Frame Protection functionality.

If the *mfp-capable* parameter enabled, the SSID supports Management Frame Protection capable clients and non-Management Frame Protection clients.



The Management Frame Protection configuration is a per-SSID configuration.

Management Frame Protection can be enabled only on WPA2-PSK and WPA2-enterprise SSIDs. The 802.11r fast roaming option will not take effect when MFP is enabled.

High Efficiency WLAN (HEW)

AOS-W Instant supports the IEEE 802.11ax standard, also known as High-Efficiency WLAN (HEW). HEW improves spectrum efficiency and area throughput in dense deployment scenarios of APs or stations in both indoor and outdoor environments. HEW enhances the 802.11 PHY and MAC channels on both 2.4 GHz and 5 GHz frequency bands.

HEW includes the following key features:

- Backward compatible with 802.11 a/b/g/n/ac.
- Better power management for longer battery life.

Configuring High Efficiency on a WLAN SSID

Most deployments do not require manual configuration of the high-efficiency SSID profile as this option is enabled by default. However, you can configure advanced high-efficiency SSID profile settings or modify default SSID profile values using the AOS-W Instant WebUI or CLI.

In the New WebUI

To enable or disable High Efficiency on a WLAN SSID:

1. Navigate to the **Configuration > Networks** page.
2. Under **Networks** select the WLAN network you want to configure and click the edit icon.
3. Click **Show advanced options** at the bottom of the window.
4. Under the **802.11** group, slide the **High efficiency** toggle switch to the right to enable the high efficiency function, or slide the toggle switch to the left if you want to disable high efficiency on the WLAN SSID.
5. Click **Next** and then **Finish**.

In the CLI

Execute the following command in the CLI to enable High Efficiency on a WLAN SSID:

```
(Instant AP) (config)# wlan ssid-profile <profile_name>
(Instant AP) (SSID Profile "<profile_name>")# high-efficiency-enable
```

Execute the following command in the CLI to disable High Efficiency on a WLAN SSID:

```
(Instant AP) (config)# wlan ssid-profile <profile_name>
(Instant AP) (SSID Profile "<profile_name>")# high-efficiency-disable
```

Disabling Short Preamble for Wireless Client

To improve the network performance and communication between the OAW-IAP and its clients, you can enable or disable the transmission and reception of short preamble frames. If the short preamble is optional for the wireless devices connecting to an SSID, you can disable short preamble through the OAW-IAP CLI. Short preamble is enabled by default.

To disable the short preamble:

```
(Instant AP)# config terminal
(Instant AP) (config)# wlan ssid-profile <ssid_profile>
(Instant AP) (SSID Profile "<ssid_profile>")# short-preamble-disable
```

Disabling a WLAN SSID Profile

You can disable an SSID profile in the AOS-W Instant WebUI or the CLI.

In the Old WebUI

To disable a WLAN SSID profile:

1. In the **Networks** tab, select the network you want to configure and click **edit**.
2. Under **WLAN Settings**, click **Show advanced options** at the bottom of the window.
3. In the **SSID** field under **Miscellaneous**, select the **Disable** check box to disable the SSID. The SSID is enabled by default.
4. Click **Next** until **Finish** to save the setting.

In the New WebUI

To disable a WLAN SSID profile:

1. Navigate to the **Configuration > Networks** page.
2. Under **Networks** select the network you want to configure and click **Edit**.
3. Under **Basic** click **Show advanced options** at the bottom of the page.
4. In the **SSID** field under **Miscellaneous**, select the **Disable** check box to disable the SSID. The SSID is enabled by default.
5. Click **Next** until **Finish** to save the setting.

In the CLI

To disable an SSID:

```
(Instant AP) (config)# wlan ssid-profile <name>
(Instant AP) (SSID Profile <name>)# disable
```

To enable an SSID:

```
(Instant AP) (config)# wlan ssid-profile <name>
(Instant AP) (SSID Profile <name>)# enable
```

Editing a WLAN SSID Profile

You can edit a WLAN SSID profile by using the AOS-W Instant WebUI.

In the Old WebUI

Editing a WLAN SSID profile:

1. In the **Networks** tab, select the network you want to configure and click **edit**.
2. Modify the settings as required under the respective tabs.
3. Click **Next** to move to the next tab.
4. Finally click **Finish** to save changes.

In the New WebUI

Editing a WLAN SSID profile:

1. Navigate to the **Configuration > Networks** page.
2. Under **Networks** select the network you want to configure and click **Edit**.
3. Modify the settings as required under the respective tabs.
4. Click **Next** to move to the next tab.
5. Finally click **Finish** to save changes.

Deleting a WLAN SSID Profile

You can delete a WLAN SSID profile by using the AOS-W Instant WebUI.

In the Old WebUI

To delete a WLAN SSID profile:

1. In the **Networks** tab, select the WLAN SSID you want to delete and click **x** beside the edit button.
2. Click **Delete Now** to confirm deletion.

In the New WebUI

To delete a WLAN SSID profile:

1. Navigate to the **Configuration > Networks** page.
2. Under **Networks** select the WLAN SSID you want to delete and click **Delete**.
3. Click **Delete Now** to confirm deletion.

Enhancements to WLAN SSID Configuration

AOS-W Instant 8.4.0.0 introduces support for configuration of up to 32 SSID profiles for cluster-based OAW-IAPs. When an SSID profile is created, an access rule with the same name is created.

Pre-Authentication and Post-Authentication Role

When you configure captive-portal authentication, two post-authentication ACLs with the same and a pre-authentication role are created in the OAW-IAP datapath. Therefore, you cannot drastically increase the count of the SSID profile.

Mapping WLAN Index and Virtual AP

Prior to the introduction of this enhancement, the mapping method of WLAN SSID profile and virtual AP was determined by the WLAN index. But this mapping method is not supported when 32 SSID profiles are configured. To support this mapping, AOS-W Instant introduces the advanced-zone feature. The benefit of this feature is that the same ESSIDs can be broadcast on OAW-IAPs that are part of the same OAW-IAP zone in a cluster.



When the advanced-zone feature is enabled and a zone is already configured with 16 SSIDs, ensure to remove the zone from two WLAN SSID profiles if you want to disable extended SSID. This action can be performed only when extended SSID is disabled.

You can configure the advanced-zone feature by using the CLI.

In the CLI

```
(Instant AP)# advanced-zone
```

Extended SSID

When extended SSID is disabled, the maximum count of zones in an SSID profile reduces to 14. This is because, the first two virtual APs are reserved for mesh. The **show ap debug network-bssid** command displays the mapping relationship between WLAN SSID profile and virtual APs.

DPI

DPI manager gathers session data periodically from the OAW-IAP datapath. Data is chunked every time a CLI command is executed to display per-AP statistics. It shows a complete cluster view that can display apps, app category, web category, and web reputation. To show a per-SSID view display, users must collect DPI manager's statistics data from an OAW-IAP to its master. The master adds the data and displays the statistics.

When data path sends the statistics data to the DPI manager, it is aware of the virtual AP ID but not the WLAN index. The DPI manager computes the statistics with the WLAN index. So except for the configured WLAN SSID, the OAW-IAP datapath must be aware of the mapping relationship of the WLAN index and virtual AP ID.

You can view the mapping of the WLAN index and BSSID by using the CLI.

In the CLI

```
(Instant AP)# show ap debug network-bssid
```

Time-Range and Out of Service

The following features make the WLAN SSID profile dynamically inactive even if the SSID zone matches with OAW-IAP zone:

- Time-range
- Out of service

To avoid the flapping of the WLAN index and virtual AP mapping, the WLAN SSID profile is disabled because of either time-range or out of service. The virtual AP status is set to inactive and not unused.

OmniVista 3600 Air Manager or Central??? Impact

OmniVista 3600 Air Manager or Central servers can view the WLAN index and BSSID mapping when OAW-IAPs (master and slave) send WLAN information to the servers.

This chapter describes the following procedures:

- [Configuring a Wired Profile on page 134](#)
- [Assigning a Profile to Ethernet Ports on page 142](#)
- [Enabling 802.3az Energy Efficient Ethernet Standard on page 142](#)
- [Editing a Wired Profile on page 143](#)
- [Deleting a Wired Profile on page 143](#)
- [LACP on page 144](#)
- [Understanding Hierarchical Deployment on page 145](#)
- [Loop Protection on page 146](#)

Configuring a Wired Profile

The Ethernet ports allow third-party devices such as VoIP phones or printers (which support only wired connections) to connect to the wireless network. You can also configure an ACL for additional security on the Ethernet downlink.

The wired profile configuration for Employee network involves the following procedures:

1. [Configuring Wired Settings on page 134](#)
2. [Configuring VLAN for a Wired Profile on page 136](#)
3. [Configuring Security Settings for a Wired Profile on page 137](#)
4. [Configuring Access Rules for a Wired Profile on page 140](#)

For information on creating a wired profile for guest network, see [Captive Portal for Guest Access](#).

Configuring Wired Settings

You can configure wired settings for a wired profile by using the AOS-W Instant WebUI or the CLI.

In the Old WebUI

1. Click the **Wired** link under **More** on the AOS-W Instant main window. The **Wired** window is displayed.
2. Click **New** under **Wired Networks**. The **New Wired Network** window is displayed.
3. Click the **Wired Settings** tab and configure the following parameters:
 - a. **Name**—Specify a name for the profile.
 - b. **Primary Usage**—Select **Employee** or **Guest**.
 - c. **Speed/Duplex**—Ensure that appropriate values are selected for **Speed/Duplex**. Contact your network administrator if you need to assign speed and duplex parameters.
 - d. **POE**—Set **POE** to **Enabled** to enable PoE.
 - e. **Admin Status**—Ensure that an appropriate value is selected. The **Admin Status** indicates if the port is up or down.
4. Click **Show advanced options** and configure the following parameters as required:
 - a. **Content Filtering**—To ensure that all DNS requests to non-corporate domains on this wired network are sent to OpenDNS, select **Enabled** for **Content Filtering**.

b. **Uplink**—Select **Enabled** to configure uplink on this wired profile. If **Uplink** is set to **Enabled** and this network profile is assigned to a specific port, the port will be enabled as Uplink port. For more information on assigning a wired network profile to a port, see [Assigning a Profile to Ethernet Ports on page 142](#).

c. **Spanning Tree**—Select the **Spanning Tree** check box to enable STP on the wired profile. STP ensures that there are no loops in any bridged Ethernet network and operates on all downlink ports, regardless of forwarding mode. STP will not operate on the uplink port and is supported only on OAW-IAPs with three or more ports. By default, Spanning Tree is disabled on wired profiles.

d. **Inactivity Timeout**—Specify the time out interval within the range of 60–86,400 seconds for inactive wired clients. The default interval is 1000 seconds.

5. Click **Next**. The **VLAN** tab details are displayed.

6. Configure VLAN for the wired profile. For more information, see [Configuring VLAN for a Wired Profile on page 136](#).

In the New WebUI

1. Navigate to the **Configuration > Networks**.

2. Under **Networks**, click **+** to create a new network.

3. Under **Name & Usage**, select **Wired** from the **Type** drop-down list box.

4. Configure the following parameters:

a. **Name**—Specify a name for the profile.

b. **Primary usage**—Select **Employee** or **Guest**.

c. **POE**—Toggle the **POE** switch to enable PoE.

d. **Admin status**—Ensure that an appropriate value is selected. The **Admin status** indicates if the port is up or down.

5. Click **Show advanced options** and configure the following parameters as required:

a. **Speed/Duplex**—Ensure that appropriate values are selected for **Speed/Duplex**. Contact your network administrator if you need to assign speed and duplex parameters.

b. **Content filtering**—To ensure that all DNS requests to non-corporate domains on this wired network are sent to OpenDNS, enable the **Content filtering** option.

c. **Uplink**—Enable the **Uplink** option to configure uplink on this wired profile. If this option is enabled and this network profile is assigned to a specific port, the port will be enabled as Uplink port. For more information on assigning a wired network profile to a port, see [Assigning a Profile to Ethernet Ports on page 142](#).

d. **Spanning Tree**—Enable the **Spanning Tree** option to enable STP on the wired profile. STP ensures that there are no loops in any bridged Ethernet network and operates on all downlink ports, regardless of forwarding mode. STP will not operate on the uplink port and is supported only on OAW-IAPs with three or more ports. By default, Spanning Tree is disabled on wired profiles.

e. **Inactivity Timeout**—Specify the time out interval within the range of 60–86,400 seconds for inactive wired clients. The default interval is 1000 seconds.

6. Click **Next**. The **VLAN** tab details are displayed.

7. Configure VLAN for the wired profile. For more information, see [Configuring VLAN for a Wired Profile on page 136](#).

In the CLI

To configure the settings for a wired profile:

```
(Instant AP) (config)# wired-port-profile <name>
(Instant AP) (wired ap profile <name>)# type {<employee>|<guest>}
```

```
(Instant AP) (wired ap profile <name>)# speed {10|100|1000|auto}
(Instant AP) (wired ap profile <name>)# duplex {half|full|auto}
(Instant AP) (wired ap profile <name>)# no shutdown
(Instant AP) (wired ap profile <name>)# poe
(Instant AP) (wired ap profile <name>)# uplink-enable
(Instant AP) (wired ap profile <name>)# content-filtering
(Instant AP) (wired ap profile <name>)# spanning-tree
```

Configuring VLAN for a Wired Profile



If you are creating a new wired profile, complete the Wired Settings procedure before configuring the VLAN settings. For more information, see [Configuring Wired Settings on page 134](#).

You can configure VLAN using the AOS-W Instant WebUI or the CLI.

In the Old WebUI

To configure a VLAN:

1. In the **VLAN** tab, enter the following information.
 - a. **Mode**—You can specify any of the following modes:
 - **Access**—Select this mode to allow the port to carry a single VLAN specified as the native VLAN.
 - **Trunk**—Select this mode to allow the port to carry packets for multiple VLANs specified as allowed VLANs.
 - b. Specify any of the following values for **Client IP Assignment**:
 - **Virtual Controller managed**: Select this option to allow the virtual switch to assign IP addresses to the wired clients. When the virtual switch assignment is used, the source IP address is translated to the physical IP address of the master OAW-IAP for all client traffic that goes through this interface. The virtual switch can also assign a guest VLAN to a wired client.
 - **Network assigned**: Select this option to allow the clients to receive an IP address from the network to which the virtual switch is connected. On selecting this option, the **New** button to create a VLAN is displayed. Create a new VLAN if required.
 - c. If the **Trunk** mode is selected:
 - Specify the VLAN in **Allowed VLANs**, enter a list of comma separated digits or ranges, for example, 1,2,5 or 1–4, or all. The Allowed VLAN refers to the VLANs carried by the port in Access mode.
 - If **Client IP assignment** is set to **Network assigned**, specify a value for **Native VLAN**. A VLAN that does not have a VLAN ID tag in the frames is referred to as Native VLAN. You can specify a value within the range of 1–4093.
 - d. If the **Access** mode is selected:
 - If **Client IP assignment** is set to **Virtual Controller managed**, proceed to step 2.
 - If **Client IP assignment** is set to **Network assigned**, specify a value for **Access VLAN** to indicate the VLAN carried by the port in the **Access** mode.
2. **Client VLAN assignment**—You can specify any of the following options.
 - **Default**—Select this option to set the default VLAN.
 - **Custom**—Select this option to configure a custom VLAN.
3. Click **Next**. The **Security** tab details are displayed.
4. Configure security settings for the wired profile. For more information, see [Configuring Security Settings for a Wired Profile on page 137](#).

In the New WebUI

To configure a VLAN:

1. In the **VLAN** tab, enter the following information.
 - a. **Mode**—You can specify any of the following modes:
 - **Access**—Select this mode to allow the port to carry a single VLAN specified as the native VLAN.
 - **Trunk**—Select this mode to allow the port to carry packets for multiple VLANs specified as allowed VLANs.
 - b. Specify any of the following values for **Client IP Assignment**:
 - **Virtual Controller managed**: Select this option to allow the virtual switch to assign IP addresses to the wired clients. When the virtual switch assignment is used, the source IP address is translated to the physical IP address of the master OAW-IAP for all client traffic that goes through this interface. The virtual switch can also assign a guest VLAN to a wired client.
 - **Network assigned**: Select this option to allow the clients to receive an IP address from the network to which the virtual switch is connected. On selecting this option, the **New** button to create a VLAN is displayed. Create a new VLAN if required.
 - c. If the **Trunk** mode is selected:
 - Specify the VLAN in **Allowed VLANs**, enter a list of comma separated digits or ranges, for example, 1,2,5 or 1–4, or all. The Allowed VLAN refers to the VLANs carried by the port in Access mode.
 - If **Client IP assignment** is set to **Network assigned**, specify a value for **Native VLAN**. A VLAN that does not have a VLAN ID tag in the frames is referred to as Native VLAN. You can specify a value within the range of 1–4093.
 - d. If the **Access** mode is selected:
 - If **Client IP assignment** is set to **Virtual Controller managed**, proceed to step 2.
 - If **Client IP assignment** is set to **Network assigned**, specify a value for **Access VLAN** to indicate the VLAN carried by the port in the **Access** mode.
2. **Client VLAN assignment**—You can specify any of the following options.
 - **Default**—Select this option to set the default VLAN.
 - **Custom**—Select this option to configure a custom VLAN.
3. Click **Next**. The **Security** tab details are displayed.
4. Configure security settings for the wired profile. For more information, see [Configuring Security Settings for a Wired Profile on page 137](#).

In the CLI

To configure VLAN settings for a wired profile:

```
(Instant AP) (config)# wired-port-profile <name>
(Instant AP) (wired ap profile <name>)# switchport-mode {trunk|access}
(Instant AP) (wired ap profile <name>)# allowed-vlan <vlan>
(Instant AP) (wired ap profile <name>)# native-vlan {<guest|1...4095>}
```

To configure a new VLAN assignment rule:

```
(Instant AP) (config)# wired-port-profile <name>
(Instant AP) (wired ap profile <name>)# set-vlan <attribute>{equals|not-equals|starts-with|
ends-with|contains| matches-regular-expression} <operator> <VLAN-ID>|value-of}
```

Configuring Security Settings for a Wired Profile

If you are creating a new wired profile, complete the Wired Settings and VLAN procedures before specifying the security settings. For more information, see [Configuring Wired Settings on page 134](#) and [Configuring VLAN Settings for a WLAN SSID Profile on page 108](#).



Configuring Security Settings for a Wired Employee Network

You can configure security parameters for the Employee network by using the AOS-W Instant WebUI or the CLI.

In the Old WebUI

To configure security parameters for the Employee network:

1. Configure the following parameters in the **Security** tab.

- **Port type**—To support trusted ports in an OAW-IAP, select **Trusted**. When the Port type is trusted, MAC and 802.1X authentication parameters cannot be configured. The Port Type is **Untrusted** by default.

In a trusted mode, OAW-IAPs will not create any user entry. A predefined ACL is applied to the trusted port in order to control the client traffic that needs to be source NATed.

- **MAC authentication**—To enable MAC authentication, select **Enabled**. The MAC authentication is disabled by default.
- **802.1X authentication**—To enable 802.1X authentication, select **Enabled**. The 802.1X authentication is disabled by default.
- **MAC authentication fail-thru**—To enable authentication fail-thru, select **Enabled**. When this feature is enabled, 802.1X authentication is attempted when MAC authentication fails. The **MAC authentication fail-thru** check box is displayed only when both **MAC authentication** and **802.1X authentication** are **Enabled**.
- Select any of the following options for **Authentication server 1**:
 - **New**—On selecting this option, an external RADIUS server must be configured to authenticate the users. For information on configuring an external server, see [Configuring an External Server for Authentication on page 198](#). [Authentication and User Management on page 185](#)
 - **Internal server**— If an internal server is selected, add the clients that are required to authenticate with the internal RADIUS server. Click the **Users** link to add users. For information on adding a user, see [Managing OAW-IAP Users on page 185](#).
- **Accounting**—Select any of the following options:
 - **Disabled**—Disables accounting.
 - **Use authentication servers**—When selected, the authentication servers configured for the wired profile are used for accounting purposes.
 - **Use separate servers**—Allows you to configure separate accounting servers.
 - **Accounting interval**—Allows you set an accounting interval within the range of 0–60 minutes for sending interim accounting information to the RADIUS server.
 - **Reauth interval**—Specify the interval at which all associated and authenticated clients must be reauthenticated.
- **Load balancing**—Set this to **Enabled** if you are using two RADIUS authentication servers, so that the load across the two RADIUS servers is balanced. For more information on the dynamic load balancing mechanism, see [Dynamic Load Balancing between Two Authentication Servers on page 198](#).



The **Accounting** parameter does not appear if the **Internal server** option is selected as the authentication server.

2. Click **Next**. The **Access** tab details are displayed.

In the New WebUI

To configure security parameters for the Employee network:

1. Configure the following parameters in the **Configuration > Networks > Security** tab.

- **Port type**—To support trusted ports in an OAW-IAP, select **Trusted**. When the Port type is trusted, MAC and 802.1X authentication parameters cannot be configured. The Port Type is **Untrusted** by default. In a trusted mode, OAW-IAPs will not create any user entry. A predefined ACL is applied to the trusted port in order to control the client traffic that needs to be source NATed.
- **MAC authentication**—Click the toggle switch to enable MAC authentication. The MAC authentication is disabled by default.
- **802.1X authentication**—Click the toggle switch to enable 802.1X authentication. The 802.1X authentication is disabled by default.
- **MAC authentication fail-thru**—Click the toggle switch to enable authentication fail-thru. When this feature is enabled, 802.1X authentication is attempted when MAC authentication fails. The **MAC authentication fail-thru** option is displayed only when both **MAC authentication** and **802.1X authentication** parameters are enabled.
- Select an existing RADIUS authentication server or + in the **Authentication server 1** drop-down list. When + is selected, an external RADIUS server must be configured to authenticate the users. For information on configuring an external server, see [Configuring an External Server for Authentication on page 198](#). [Authentication and User Management on page 185](#)
- **Accounting**—Select any of the following options.
 - **Disabled**—Disables accounting.
 - **Use authentication servers**—When selected, the authentication servers configured for the wired profile are used for accounting purposes.
 - **Use separate servers**—Allows you to configure separate accounting servers.
 - **Accounting interval**—Allows you set an accounting interval within the range of 0–60 minutes for sending interim accounting information to the RADIUS server.
 - **Reauth interval**—Specify the interval at which all associated and authenticated clients must be reauthenticated.
- **Load balancing**—Click the toggle switch if you are using two RADIUS authentication servers, so that the load across the two RADIUS servers is balanced. For more information on the dynamic load balancing mechanism, see [Dynamic Load Balancing between Two Authentication Servers on page 198](#).



The **Accounting** parameter does not appear if the **Internal server** option is selected as the authentication server.

2. Click **Next**. The **Access** tab details are displayed.

In the CLI

To configure security settings for an employee network:

```
(Instant AP) (config)# wired-port-profile <name>
(Instant AP) (wired ap profile <name>)# mac-authentication
(Instant AP) (wired ap profile <name>)# l2-auth-failthrough
(Instant AP) (wired ap profile <name>)# auth-server <name>
(Instant AP) (wired ap profile <name>)# server-load-balancing
(Instant AP) (wired ap profile <name>)# radius-accounting
(Instant AP) (wired ap profile <name>)# radius-accounting-mode {user-association|user-
authentication}
(Instant AP) (wired ap profile <name>)# radius-interim-accounting-interval <minutes>
(Instant AP) (wired ap profile <name>)# radius-reauth-interval <Minutes>
(Instant AP) (wired ap profile <name>)# trusted
```

Configuring Access Rules for a Wired Profile

The Ethernet ports allow third-party devices such as VoIP phones or printers (that support only wired connections) to connect to the wireless network. You can also configure an ACL for additional security on the Ethernet downlink.



If you are creating a new wired profile, complete the Wired Settings and configure the VLAN and security parameters before defining access rules. For more information, see [Configuring Wired Settings on page 134](#), [Configuring VLAN for a Wired Profile on page 136](#), and [Configuring Security Settings for a Wired Profile on page 137](#).

You can configure access rules by using the AOS-W Instant WebUI or the CLI.

In the Old WebUI

To configure access rules:

1. On the **Access** tab, configure the following access rule parameters.
 - a. Select any of the following types of access control:
 - **Role-based**—Allows the users to obtain access based on the roles assigned to them.
 - **Network-based**—Allows the users to be authenticated based on access rules specified for a network.
 - **Unrestricted**—Allows the users to obtain unrestricted access on the port.
 - b. If the **Role-based** access control is selected, perform the following steps:
 - Under **Roles**, select an existing role for which you want to apply the access rules, or click **New** and add the required role. The list of roles defined for all networks is displayed under **Roles**.



The default role with the same name as the network is automatically defined for each network. The default roles cannot be modified or deleted.

- Select the access rule associated with a specific role and modify if required. To add a new access rule, click **New** in the **Access Rules** window. You can configure up to 64 access rules. For more information on configuring access rules, see [Configuring ACL Rules for Network Services on page 240](#).
- Configure rules to assign roles for an authenticated client. You can also configure rules to derive VLANs for the wired network profile. For more information on role assignment rules and VLAN derivation rules, see [Configuring Derivation Rules on page 264](#) and [Configuring VLAN Derivation Rules on page 270](#).
- Select the **Assign pre-authentication role** check box to add a pre-authentication role that allows some access to the users before client authentication.
- Select the **Enforce Machine Authentication** check box, to configure access rights to clients based on whether the client device supports machine authentication. Select the **Machine auth only** and **User auth only** rules. Machine Authentication is only supported on Windows devices and devices such as iPads.



If **Enforce Machine Authentication** is enabled, both the device and the user must be authenticated for the role assignment rule to apply.

2. Click **Finish**.

In the New WebUI

To configure access rules:

1. In the **Access** tab, configure the following access rule parameters.
 - a. In the **Access Rules** drop-down list box, select any of the following types of access control:

- **Role-based**—Allows the users to obtain access based on the roles assigned to them.
 - **Network-based**—Allows the users to be authenticated based on access rules specified for a network.
 - **Unrestricted**—Allows the users to obtain unrestricted access on the port.
- b. If the **Role-based** access control is selected, perform the following steps:
- Under **Roles**, select an existing role for which you want to apply the access rules, or click + and add the required role. The list of roles defined for all networks is displayed under **Roles**.



The default role with the same name as the network is automatically defined for each network. The default roles cannot be modified or deleted.

- Select the access rule associated with a specific role and modify if required. To add a new access rule, click + in the **Access Rules for <network>** window. You can configure up to 64 access rules. For more information on configuring access rules, see [Configuring ACL Rules for Network Services on page 240](#).
- Configure rules to assign roles for an authenticated client. You can also configure rules to derive VLANs for the wired network profile. For more information on role assignment rules and VLAN derivation rules, see [Configuring Derivation Rules on page 264](#) and [Configuring VLAN Derivation Rules on page 270](#).
- In the **Role Assignment Rules** window, click the **Enforce Machine Authentication** toggle switch to configure access rights to clients based on whether the client device supports machine authentication. Select the **Machine auth only** and **User auth only** rules. Machine Authentication is only supported on Windows devices and devices such as iPads.
- Toggle the **Enforce MAC auth only role** switch to specify roles for only MAC authenticated users.



If **Enforce Machine Authentication** is enabled, both the device and the user must be authenticated for the role assignment rule to apply.

2. Click **Next**.

3. In the **Assignment** tab, click **Finish**. For more information, refer to [Assigning a Profile to Ethernet Ports on page 142](#)

In the CLI

To configure access rules for a wired profile:

```
(Instant AP) (config)# wired-port-profile <name>
(Instant AP) (wired ap profile <name>)# access-rule-name <name>
```

To configure role assignment rules:

```
(Instant AP) (config)# wired-port-profile <name>
(Instant AP) (wired ap profile <name>)# set-role <attribute>{{equals|not-equal|starts-with|
ends-with|contains|matches-regular-expression}<operator> <role>|value-of}
```

To configure a pre-authentication role:

```
(Instant AP) (config)# wired-port-profile <name>
(Instant AP) (wired ap profile <name>)# set-role-pre-auth <role>
```

To configure machine and user authentication roles:

```
(Instant AP) (config)# wired-port-profile <name>
(Instant AP) (wired ap profile <name>)# set-role-machine-auth <machine_only> <user-only>
```

To configure unrestricted access:

```
(Instant AP) (config)# wired-port-profile <name>
(Instant AP) (wired ap profile <name>)# set-role-unrestricted
```

Assigning a Profile to Ethernet Ports

You can assign profiles to Ethernet ports using the AOS-W Instant WebUI or the CLI:

In the Old WebUI

To assign wired profiles to Ethernet ports:

1. Click the **Wired** link under **More** on the AOS-W Instant main window. The **Wired** window is displayed.
2. To assign an Ethernet downlink profile to Ethernet 0 port:
 - a. Ensure that the wired bridging on the port is enabled. For more information, see [Configuring Wired Bridging on Ethernet 0 for Mesh Point on page 447](#).
 - b. Under **Network assignments**, select and assign a profile from the **0/0** drop-down list.
 - c. To assign a wired profile to Ethernet 0/1 port, select the profile from the **0/1** drop-down list.
 - d. If the OAW-IAP supports Ethernet 2, Ethernet 3, and Ethernet 4 ports, assign profiles to other Ethernet ports by selecting a profile from the **0/2**, **0/3**, and **0/4** drop-down lists.
 - e. Click **OK**.

In the New WebUI

To assign wired profiles to Ethernet ports:

1. Navigate to the **Configuration > Networks** page.
2. Select the wired network profile to which you want to assign Ethernet ports and click **Edit**.
3. Go to the **Assignment** tab.
4. To assign an Ethernet downlink profile to Ethernet 0 port:
 - a. Ensure that the wired bridging on the port is enabled. For more information, see [Configuring Wired Bridging on Ethernet 0 for Mesh Point on page 447](#).
 - b. Select and assign a profile from the **0/0** drop-down list.
 - c. To assign a wired profile to Ethernet 0/1 port, select the profile from the **0/1** drop-down list.
 - d. If the OAW-IAP supports Ethernet 2, Ethernet 3, and Ethernet 4 ports, assign profiles to other Ethernet ports by selecting a profile from the **0/2**, **0/3**, and **0/4** drop-down lists.
5. Click **Finish**.

In the CLI

To assign profiles to Ethernet ports:

```
(Instant AP) (config)# enet0-port-profile <name>
(Instant AP) (config)# enet1-port-profile <name>
(Instant AP) (config)# enet2-port-profile <name>
(Instant AP) (config)# enet3-port-profile <name>
(Instant AP) (config)# enet4-port-profile <name>
```

Enabling 802.3az Energy Efficient Ethernet Standard

Most new models of Alcatel-Lucent APs support the 802.3az or Energy Efficient Ethernet standard, which allows the APs to consume less power during periods of low data activity. This setting can be enabled for provisioned OAW-IAPs or OAW-IAP groups through the wired port profile. After enabling EEE, the wired port profile can be linked individually to the ethernet ports. If this feature is enabled for an OAW-IAP group, any OAW-IAPs in the group that do not support 802.3az will ignore this setting.



802.3az or EEE is not supported on OAW-AP215, OAW-AP315, and OAW-AP330 Series access points

In the CLI

To enable 802.3az Energy Efficient Ethernet standard on an OAW-IAP and associate it with an ethernet port:

```
(Instant AP) (config)# wired-port-profile <profile_name>
(Instant AP) (wired ap profile <profile_name>)# dot3az
(Instant AP) (wired ap profile <profile_name>)# exit
(Instant AP) (config)# enet0-port-profile <profile_name>
(Instant AP) (config)# end
(Instant AP)# commit apply
```

To view the dot3az status for the ethernet ports:

```
(Instant AP)# show port status
Port Status
-----
Port   Type   Admin-State   Oper-State   STP-State   Dot3az
-----
eth0   5GE    up            up           N/A         Enable
eth1   GE     up            down        N/A         Disable
```

Editing a Wired Profile

You can edit a wired profile by using the AOS-W Instant WebUI.

In the Old WebUI

To edit a wired profile:

1. Click the **Wired** link under **More** on the AOS-W Instant main window. The **Wired** window is displayed.
2. In the **Wired Networks** window, select the wired profile to modify.
3. Click **Edit**. The **Edit Wired Network** window is displayed.
4. Modify the required settings.
5. In the **Access** tab, click **Finish** to save the modifications.

In the New WebUI

To edit a wired profile:

1. Navigate to the **Configuration > Networks** page.
2. Under Networks, select the wired profile and click **Edit**.
3. Modify the required settings under the respective tabs.
4. Click **Next** until **Finish** to save the modifications.

Deleting a Wired Profile

You can delete a wired profile by using the Instant WebUI.

In the Old WebUI

To delete a wired profile:

1. Click the **Wired** link under **More** on the AOS-W Instant main window. The **Wired** window is displayed.
2. In the **Wired** window, select the wired profile to delete.
3. Click **Delete**. The wired profile will be deleted.

In the New WebUI

To delete a wired profile:

1. Navigate to the **Configuration > Networks** page.
2. Under **Networks**, select the wired profile to delete and click **Delete**.
3. Click **Delete Now** to confirm deletion.

LACP

The OAW-AP 220 Series access points and OAW-AP270 Series support the IEEE 802.11ac standard for high-performance WLAN. To support maximum traffic, port aggregation is required as it increases throughput and enhances reliability. To support port aggregation, AOS-W Instant supports LACP based on the IEEE 802.3ad standard. The 802.3ad standard for Ethernet aggregation uses LACP as a method to manage link configuration and balance traffic among aggregated ports.

LACP provides a standardized means for exchanging information with partner systems to form a dynamic LAG. The LACP feature is automatically enabled during OAW-IAP boots and it dynamically detects the OAW-IAP if connected to a partner system with LACP capability, by checking if there is any LACP PDU received on either Ethernet 0 or Ethernet 1 port.

If a switch in the cluster has the LACP capability, you can combine Ethernet 0 or Ethernet 1 interfaces into the LAG to form a single logical interface (port-channel). Port-channels can be used to provide additional bandwidth or link redundancy between two devices. OAW-IAP supports link aggregation using either standard port-channel (configuration based) or LACP (protocol signaling based). You can deploy OAW-AP 220 Series or OAW-AP270 Series access points with LACP configuration to benefit from the higher (greater than 1 Gbps) aggregate throughput capabilities of the two radios.



The LACP feature is supported on OAW-AP 220 Series, OAW-AP270 Series, OAW-AP320 Series, and OAW-AP330 Series access points.

Verifying LACP Configuration on the OAW-IAP

There is no configuration required on the OAW-IAP for enabling LACP support. However, you can view the status of LACP on OAW-IAPs by using the following command:

```
(Instant AP)# show lacp status
AP LACP Status
-----
Link Status  LACP Rate  Num Ports  Actor Key  Partner Key  Partner MAC
-----
Up           slow       2          17         1           70:81:05:11:3e:80
Slave Interface Status
-----
Slave I/f Name  Permanent MAC Addr  Link Status  Member of LAG  Link Fail Count
-----
eth0           6c:f3:7f:c6:76:6e   Up           Yes            0
eth1           6c:f3:7f:c6:76:6f   Up           Yes            0
Traffic Sent on Enet Ports
-----
Radio Num  Enet 0 Tx Count  Enet 1 Tx Count
-----
0          0                0
1          0                0
non-wifi   2                17
```

Enabling Static LACP Configuration

When OAW-IAPs connect to switches which have the LACP capability, the LACP feature does not work as expected. To enable a static LACP configuration, new commands are introduced.

OAW-IAPs support the dynamic LACP configuration according to a peer switch. When the peer switch enables LACP configuration, the OAW-IAPs form the LACP. Users can enable, disable, and remove the static LACP configuration in the OAW-IAP. When the OAW-IAP boots up, it forms the LACP according to the static configuration.



The static LACP mode is supported on OAW-AP 220 Series, OAW-AP270 Series, OAW-AP320 Series, and OAW-AP330 Series access points.

To enable the static LACP mode on OAW-IAPs:

```
(Instant AP)# lacp-mode enable
```

To disable the static LACP mode on OAW-IAPs:

```
(Instant AP)# lacp-mode disable
```

Verifying Static LACP Mode

To verify the static LACP configuration, execute the following command in the OAW-IAP CLI:

```
(Instant AP)# show ap-env
Antenna Type:Internal
name:TechPubsAP
per_ap_ssid:1234
per_ap_vlan:abc
lacp_mode:enable
```

Understanding Hierarchical Deployment

An OAW-IAP with more than one wired port can be connected to the downlink wired port of another OAW-IAP. An OAW-IAP with a single Ethernet port (like OAW-IAP90 or OAW-IAP100 Series access points) can be provisioned to use Ethernet bridging, so that Ethernet 0 port is converted to a downlink wired port.

You can also form an OAW-IAP network by connecting the downlink port of an OAW-IAP to other OAW-IAPs. Only one OAW-IAP in the network uses its downlink port to connect to the other OAW-IAPs. This OAW-IAP (called the root OAW-IAP) acts as the wired device for the network, provides DHCP service and an L3 connection to the ISP uplink with NAT. The root OAW-IAP is always the master of the AOS-W Instant network. In a single Ethernet port platform deployment, the root OAW-IAP must be configured to use the 3G uplink.

A typical hierarchical deployment consists of the following:

- A direct wired ISP connection or a wireless uplink.
- One or more DHCP pools for private VLANs.
- One downlink port configured on a private VLAN without authentication for connecting to slave OAW-IAPs. Ensure that the downlink port configured in a private VLAN is not used for any wired client connection. Other downlink ports can be used for connecting to the wired clients.

The following figure illustrates a hierarchical deployment scenario:

Figure 4 Hierarchical Deployment

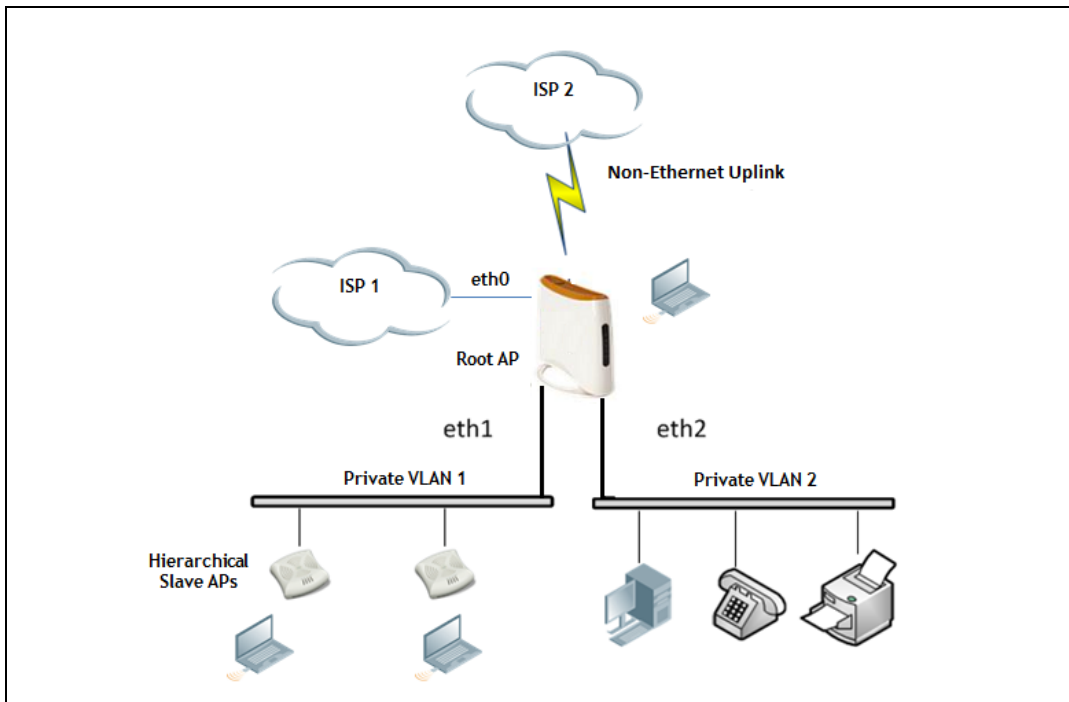

Loop Protection

Alcatel-Lucent AOS-W Instant 8.4.0.0 introduces the loop protection feature that detects and avoids the formation of loops on the Ethernet ports of an OAW-IAP.

The loop protect feature can be enabled on all OAW-IAPs that have multiple Ethernet ports and it supports tunnel, split-tunnel, and bridge modes.

The loop protection feature prevents the formation of loops when:

- An unmanaged switch is connected to one port of an OAW-IAP and a loop forms in the unmanaged switch.
- The WAN port (port 0) and either of ports 1, 2, 3, or 4, if it exists, in an AP are connected to the same switch.
- Multiple ports in an OAW-IAP are connected to an unmanaged switch.

The loop protection feature transmits a proprietary loop detection packet on one Ethernet port of an OAW-IAP at the configured loop-protect interval (default value is 2 seconds). The loop protect feature transmits the loop detection packet without a VLAN tag irrespective of whether the Ethernet port of the OAW-IAP is connected in access mode or trunk mode. That is, for trunk mode, loop protect is supported only in the native VLAN.

- If the same packet is received on the same Ethernet port of the OAW-IAP, a loop in the downstream switch is detected and the Ethernet port of the OAW-IAP is shut down.
- If the same packet is received on the WAN port (port 0) of the OAW-IAP, a loop between the Ethernet and WAN ports of the AP is detected and the Ethernet port of the OAW-IAP is shut down.
- If the same packet is received on another Ethernet port of the OAW-IAP, a loop between the Ethernet ports of the OAW-IAP is detected and the Ethernet port of the OAW-IAP port with lower priority is shut down. The Ethernet port with smaller port ID has high priority.

The Ethernet port of the OAW-IAP that is shut down because of loop protection is marked with status **Loop-ERR**. A user can either recover the shut down port from the OAW-IAP with manual intervention or enable automatic recovery mode and configure an automatic recovery interval. At the expiry of the automatic recovery interval, the **Loop-ERR** status of the Ethernet port is cleared and the Ethernet port is re-enabled automatically.

To prevent the downstream switch from dropping the loop detection packet, for example during broadcast storm state, if the OAW-IAP takes longer time, or if the OAW-IAP fails to detect a loop, a broadcast storm-control mechanism is provided as part of the loop protection feature. During broadcast-storm control, an OAW-IAP counts the broadcast packets received on each of its Ethernet port and determines the packet rate in an interval. If the broadcast packet rate on one Ethernet port exceeds the configured threshold (default value is 2000 packets per second), the Ethernet port is shut down.

Configuring Loop Protection

In the CLI

To configure loop protection for the wired profile:

```
(Instant AP) (config)# wired-port-profile <name>
(Instant AP) (wired ap profile <name>)# loop-protect
(Instant AP) (wired ap profile <name>)# loop-detection-interval 5
```

To configure automatic recovery for a wired profile:

```
(Instant AP) (config)# wired-port-profile <name>
(Instant AP) (wired ap profile <name>)# auto-recovery
(Instant AP) (wired ap profile <name>)# auto-recovery-interval 50
```

To configure broadcast storm control:

```
(Instant AP) (config)# wired-port-profile <name>
(Instant AP) (wired ap profile <name>)# storm-control-broadcast
(Instant AP) (wired ap profile <name>)# storm-control-threshold 110
```

This chapter provides the following information:

- [Understanding Captive Portal on page 148](#)
- [Configuring a WLAN SSID for Guest Access on page 149](#)
- [Configuring Wired Profile for Guest Access on page 158](#)
- [IGMP on page 161](#)
- [Configuring Internal Captive Portal for Guest Network on page 161](#)
- [Configuring External Captive Portal for a Guest Network on page 166](#)
- [Configuring Facebook Login on page 174](#)
- [Configuring Guest Logon Role and Access Rules for Guest Users on page 177](#)
- [Configuring Captive Portal Roles for an SSID on page 179](#)
- [Configuring Walled Garden Access on page 183](#)
- [Disabling Captive Portal Authentication on page 183](#)

Understanding Captive Portal

AOS-W Instant supports the captive portal authentication method, where a web page is presented to the guest users when they try to access the Internet from hotels, conference centers, or Wi-Fi hotspots. The web page also prompts the guest users to authenticate or accept the usage policy and terms. Captive portals are used at many Wi-Fi hotspots and can be used to control wired access as well.

The AOS-W Instant captive portal solution consists of the following:

- The captive portal web login page hosted by an internal or external server.
- The RADIUS authentication or user authentication against OAW-IAP's internal database.
- The SSID broadcast by the OAW-IAP.

Using AOS-W Instant, the administrators can create a wired or WLAN guest network based on captive portal authentication for guests, visitors, contractors, and any non-employee users who can use the enterprise Wi-Fi network. The administrators can also create guest accounts and customize the captive portal page with organization-specific logo, terms, and usage policy. With captive portal authentication and guest profiles, the devices that connect to the guest SSID are assigned IP addresses and an initial role. When a guest user tries to access a URL through HTTP or HTTPS, the captive portal web page prompting the user to authenticate with a username and password is displayed.

Types of Captive Portal

AOS-W Instant supports the following types of captive portal authentication:

- **Internal captive portal**—For Internal captive portal authentication, an internal server is used for hosting the captive portal service. It supports the following types of authentication:
 - **Internal Authenticated**—When **Internal Authenticated** is enabled, a guest user must authenticate in the captive portal page to access the Internet. The guest users who are required to authenticate must already be added to the user database.
 - **Internal Acknowledged**—When **Internal Acknowledged** is enabled, a guest user must accept the terms and conditions to access the Internet.

- **External captive portal**—For external captive portal authentication, an external portal on the cloud or on a server outside the enterprise network is used.

Walled Garden

The administrators can also control the resources that the guest users can access and the amount of bandwidth or airtime they can use at any given time. When an external captive portal is used, the administrators can configure a walled garden, which determines access to the URLs requested by the guest users. For example, a hotel environment where the unauthenticated users are allowed to navigate to a designated login page (for example, a hotel website) and all its contents. The users who do not sign up for the Internet service can view only the “allowed” websites (typically hotel property websites).

The administrators can allow or block access to specific URLs by creating a whitelist and blacklist. When the users attempt to navigate to other websites, which are not in the whitelist of the walled garden profile, the users are redirected to the login page. If the requested URL is on the blacklist, it is blocked. If it appears on neither list, the request is redirected to the external captive portal.

Configuring a WLAN SSID for Guest Access

You can create an SSID for guest access by using the AOS-W Instant WebUI or the CLI:

In the Old WebUI

To create an SSID for guest access:

1. In the **Networks** tab of the AOS-W Instant main window, click the **New** link. The **New WLAN** window is displayed.
2. Enter a name that uniquely identifies a wireless network in the **Name (SSID)** text box.
3. Select **Guest** from the **Primary usage** drop-down menu.
4. Click the **Show advanced options** link. The advanced options for configuration are displayed.
5. Enter the required values for the following configuration parameters:

Table 30: WLAN Configuration Parameters

Parameter	Description
Broadcast filtering	<p>Select any of the following values:</p> <ul style="list-style-type: none"> ■ All—When set to All, the OAW-IAP drops all broadcast and multicast frames except DHCP and ARP, IGMP group queries, and IPv6 neighbor discovery protocols. ■ ARP—When set to ARP, the OAW-IAP drops all broadcast and multicast frames except DHCP and ARP, IGMP group queries, and IPv6 neighbor discovery protocols and additionally converts ARP requests to unicast and send frames directly to the associated client. ■ Unicast-ARP-Only — When set to Unicast-ARP-Only, the OAW-IAP allows all broadcast and multicast frames as it is, however the ARP requests are converted to unicast frames and sends them to the associated clients. The broadcast filtering is set to Unicast-ARP-Only by default when an SSID profile is created. ■ Disabled— When set to Disabled, all broadcast and multicast traffic is forwarded to the wireless interfaces.
Multicast transmission optimization	<p>Select Enabled if you want the OAW-IAP to select the optimal rate for sending 802.11 broadcast and multicast frames based on the lowest of unicast rates across all associated clients. When this option is enabled, multicast traffic can be sent at up to 24 Mbps. The default rate for sending frames for 2.4 GHz is 1 Mbps and 5 GHz is 6 Mbps. This option is disabled by default.</p>
Dynamic multicast optimization	<p>Select Enabled to allow OAW-IAP to convert multicast streams into unicast streams over the wireless link. Enabling DMO enhances the quality and reliability of streaming video, while preserving the bandwidth available to the non-video clients.</p> <p>NOTE: When you enable DMO on multicast SSID profiles, ensure that the DMO feature is enabled on all SSIDs configured in the same VLAN.</p>
DMO channel utilization threshold	<p>Specify a value to set a threshold for DMO channel utilization. With DMO, the OAW-IAP converts multicast streams into unicast streams as long as the channel utilization does not exceed this threshold. The default value is 90% and the maximum threshold value is 100%. When the threshold is reached or exceeds the maximum value, the OAW-IAP sends multicast traffic over the wireless link.</p>
Transmit Rates	<p>Specify the following parameters:</p> <ul style="list-style-type: none"> ■ 2.4 GHz—If the 2.4 GHz band is configured on the OAW-IAP, specify the minimum and maximum transmission rate. The default value for minimum transmission rate is 1 Mbps and maximum transmission rate is 54 Mbps. ■ 5 GHz—If the 5 GHz band is configured on the OAW-IAP, specify the minimum and maximum transmission rate. The default value for minimum transmission rate is 6 Mbps and maximum transmission rate is 54 Mbps.
Band	<p>Select a value to specify the band at which the network transmits radio signals. You can set the band to 2.4 GHz, 5 GHz, or All. The All option is selected by default.</p>
DTIM interval	<p>The DTIM interval indicates the DTIM period in beacons, which can be configured for every WLAN SSID profile. The DTIM interval determines how often the OAW-IAP should deliver the buffered broadcast and multicast frames to associated clients in the powersave mode. The default value is 1 beacon, which means the client checks for buffered data on the OAW-IAP at every beacon. You can also configure a higher DTIM value for power saving.</p>
Min RSSI for probe request	<p>Sets a minimum RSSI threshold for probe requests.</p>
Min RSSI for auth request	<p>Sets a minimum RSSI threshold for authentication requests.</p>

Table 30: WLAN Configuration Parameters

Parameter	Description
Very high throughput	Enables VHT function on OAW-IAP devices that support VHT. For 802.11ac OAW-IAPs, the VHT function is enabled by default. However, you can disable the VHT function if you want the 802.11ac OAW-IAPs to function as 802.11n OAW-IAPs. If VHT is configured or disabled on an SSID, the changes will apply only to the SSID on which it is enabled or disabled.
Zone	Specify the zone for the SSID. When the zone is defined in SSID profile and if the same zone is defined on an OAW-IAP, the SSID is created on that OAW-IAP. For more information on configuring zone details, see Configuring Zone Settings on an OAW-IAP on page 78 . The following constraints apply to the zone configuration: <ul style="list-style-type: none"> ■ An OAW-IAP can belong to only one zone and only one zone can be configured on an SSID. ■ If an SSID belongs to a zone, all OAW-IAPs in this zone can broadcast this SSID. If no OAW-IAP belongs to the zone configured on the SSID, the SSID is not broadcast. ■ If an SSID does not belong to any zone, all OAW-IAPs can broadcast this SSID.
Time Range	Click Edit , select a Time Range Profile from the list and specify if the profile must be enabled or disabled for the SSID, and then click OK .
Bandwidth Limits	Under Bandwidth Limits : <ul style="list-style-type: none"> ■ Airtime—Select this check box and specify an aggregate amount of airtime that all clients in this network can use for sending and receiving data. Specify the airtime percentage. ■ Each radio—Select this check box to specify an aggregate amount of throughput that each radio is allowed to provide for the connected clients. ■ Downstream and Upstream—Specify the downstream and upstream rates within a range of 1 to 65,535 Kbps for the SSID users. If the assignment is specific for each user, select the Peruser check box.
WMM	Configure the following options for WMM traffic management. WMM supports voice, video, best effort, and background access categories. To allocate bandwidth for the following types of traffic, specify a percentage value under Share . To configure DSCP mapping, specify a value under DSCP Mapping . <ul style="list-style-type: none"> ■ Background WMM—For background traffic such as file downloads or print jobs. ■ Best effort WMM—For best effort traffic such as traffic from legacy devices or traffic from applications or devices that do not support QoS. ■ Video WMM—For video traffic generated from video streaming. ■ Voice WMM—For voice traffic generated from the incoming and outgoing voice communication. For more information on WMM traffic and DSCP mapping, see WMM Traffic Management on page 370 .
	For voice traffic and Spectralink Voice Prioritization, configure the following parameters: <ul style="list-style-type: none"> ■ Traffic Specification (TSPEC)—To prioritize time-sensitive traffic such as voice traffic initiated by the client, select the Traffic Specification (TSPEC) check box. ■ TSPEC Bandwidth—To reserve bandwidth, set the TPSEC bandwidth to the desired value within the range of 200–600,000 Kbps. The default value is 2000 Kbps. ■ Spectralink Voice Protocol (SVP)—Select the check box to prioritize voice traffic for SVP handsets.
Content filtering	Select Enabled to route all DNS requests for the non-corporate domains to OpenDNS on this network.
Inactivity timeout	Specify an interval for session timeout in seconds, minutes or hours. If a client session is inactive for the specified duration, the session expires and the users are required to log in again. You can specify a value within the range of 60-86,400 seconds or up to 24 hours for a client session. The default value is 1000 seconds.

Table 30: WLAN Configuration Parameters

Parameter	Description
Deauth Inactive Clients	Select Enabled to allow the OAW-IAP to send a deauthentication frame to the inactive client and clear client entry.
SSID	Select the Hide check box if you do not want the SSID (network name) to be visible to users. Select the Disable check box if you want to disable the SSID. On selecting this, the SSID will be disabled, but will not be removed from the network. By default, all SSIDs are enabled.
ESSID	Enter the ESSID. If the value defined for ESSID value is not the same as profile name, the SSIDs can be searched based on the ESSID value and not by its profile name.
Out of service (OOS)	Enable or disable the SSID based on the following out-of-service states of the OAW-IAP: <ul style="list-style-type: none"> ■ VPN down ■ Uplink down ■ Internet down ■ Primary uplink down The network will be out of service when selected event occurs and the SSID is enabled or disabled as per the configuration settings applied. For example, if you select the VPN down option from the drop-down list and set the status to enabled, the SSID is enabled when the VPN connection is down and is disabled when the VPN connection is restored.
OOS time (global)	Configure a hold time interval in seconds within a range of 30 to 300 seconds, after which the out-of-service operation is triggered. For example, if the VPN is down and the configured hold time is 45 seconds, the effect of this out-of-service state impacts the SSID availability after 45 seconds.
Max clients threshold	Specify the maximum number of clients that can be configured for each BSSID on a WLAN. You can specify a value within the range of 0 to 255. The default value is 64.
SSID Encoding	To encode the SSID, select UTF8. By default, the SSIDs are not encoded.
Deny inter user bridging	When enabled, the bridging traffic between two clients connected to the same SSID on the same VLAN is disabled. The clients can connect to the Internet, but cannot communicate with each other, and the bridging traffic between the clients is sent to the upstream device to make the forwarding decision.
Openflow	When enabled, users can run and manage multiple instances of the control-plane and dataplane from a centralized location. OpenFlow also ensures uniform policy enforcement.

6. Click **Next** to configure VLAN settings. The VLAN tab contents are displayed.

7. Select any for the following options for **Client IP assignment**:

- **Virtual Controller managed**—On selecting this option, the client obtains the IP address from the virtual switch. When this option is used, the source IP address is translated to the physical IP address of the master OAW-IAP for all client traffic that goes through this interface. The virtual switch can also assign a guest VLAN to the client.
- **Network assigned**—On selecting this option, the IP address is obtained from the network.

8. Based on the type client IP assignment mode selected, you can configure the VLAN assignment for clients as described in the following table:

Table 31: IP and VLAN Assignment for WLAN SSID Clients

Client IP Assignment	Client VLAN Assignment
Virtual Controller managed	<p>If the Virtual Controller managed is selected for client IP assignment, the virtual switch creates a private subnet and VLAN on the OAW-IAP for the wireless clients. The NAT for all client traffic that goes out of this interface is carried out at the source. This setup eliminates the need for complex VLAN and IP address management for a multi-site wireless network. On selecting this option, the following client VLAN assignment options are displayed:</p> <ul style="list-style-type: none"> ■ Default: When selected, the default VLAN as determined by the virtual switch is assigned for clients. ■ Custom: When selected, you can specify a custom VLAN assignment option. You can select an existing DHCP scope for client IP and VLAN assignment or you can create a new DHCP scope by selecting New. For more information on DHCP scopes, see Configuring DHCP Scopes on page 276.
Network assigned	<p>If the Network assigned is selected, you can specify any of the following options for the Client VLAN assignment.</p> <ul style="list-style-type: none"> ■ Default—On selecting this option, the client obtains the IP address in the same subnet as the OAW-IAPs. By default, the client VLAN is assigned to the native VLAN on the wired network. ■ Static—On selecting this option, you need to specify a single VLAN, a comma separated list of VLANs, or a range of VLANs for all clients on this network. Select this option for configuring VLAN pooling. ■ Dynamic—On selecting this option, you can assign the VLANs dynamically from a DHCP server. To create VLAN assignment rules, click New to assign the user to a VLAN. In the New VLAN Assignment Rule window, enter the following information: <ul style="list-style-type: none"> ■ Attribute—Select an attribute returned by the RADIUS server during authentication. ■ Operator—Select an operator for matching the string. ■ String—Enter the string to match ■ VLAN—Enter the VLAN to be assigned.

9. Click **Next** to configure [internal](#) or [external captive portal authentication, roles, and access rules](#) for the guest users.



If the client IP assignment mode is set to **Network assigned** in a guest SSID profile, the guest clients can log out of the captive portal network by accessing the <https://securelogin.arubanetworks.com/auth/logout.html> URL.

In the New WebUI

To create an SSID for guest access:

1. Navigate to the **Configuration > Networks** page.
2. Under **Networks**, click **+**.
3. Under Basic option, Enter a name that uniquely identifies a wireless network in the **Name** field.



The SSID name must be unique and may contain any special character except for ' and ''.

4. In the **Type** drop-down list, select **Wireless**.
5. In the **Primary usage** drop-down menu, select **Guest**.
6. Click the **Show advanced options** link. The advanced options for configuration are displayed.
7. Enter the required values for the following configuration parameters:

Table 32: WLAN Configuration Parameters

Parameter	Description
Broadcast filtering	<p>Select any of the following values:</p> <ul style="list-style-type: none"> ■ All—When set to All, the OAW-IAP drops all broadcast and multicast frames except DHCP and ARP, IGMP group queries, and IPv6 neighbor discovery protocols. ■ ARP—When set to ARP, the OAW-IAP drops all broadcast and multicast frames except DHCP and ARP, IGMP group queries, and IPv6 neighbor discovery protocols and additionally converts ARP requests to unicast and send frames directly to the associated client. ■ Unicast-ARP-Only — When set to Unicast-ARP-Only, the OAW-IAP allows all broadcast and multicast frames as it is, however the ARP requests are converted to unicast frames and sends them to the associated clients. The broadcast filtering is set to Unicast-ARP-Only by default when an SSID profile is created. ■ Disabled— When set to Disabled, all broadcast and multicast traffic is forwarded to the wireless interfaces.
Multicast transmission optimization	<p>Click the toggle switch if you want the OAW-IAP to select the optimal rate for sending 802.11 broadcast and multicast frames based on the lowest of unicast rates across all associated clients. When this option is enabled, multicast traffic can be sent at up to 24 Mbps. The default rate for sending frames for 2.4 GHz is 1 Mbps and 5 GHz is 6 Mbps. This option is disabled by default.</p>
Dynamic multicast optimization	<p>Click the toggle switch to allow OAW-IAP to convert multicast streams into unicast streams over the wireless link. Enabling DMO enhances the quality and reliability of streaming video, while preserving the bandwidth available to the non-video clients.</p> <p>NOTE: When you enable DMO on multicast SSID profiles, ensure that the DMO feature is enabled on all SSIDs configured in the same VLAN.</p>
DMO channel utilization threshold	<p>Specify a value to set a threshold for DMO channel utilization. With DMO, the OAW-IAP converts multicast streams into unicast streams as long as the channel utilization does not exceed this threshold. The default value is 90% and the maximum threshold value is 100%. When the threshold is reached or exceeds the maximum value, the OAW-IAP sends multicast traffic over the wireless link.</p>
Transmit Rates	<p>Specify the following parameters:</p> <ul style="list-style-type: none"> ■ 2.4 GHz—If the 2.4 GHz band is configured on the OAW-IAP, specify the minimum and maximum transmission rate. The default value for minimum transmission rate is 1 Mbps and maximum transmission rate is 54 Mbps. ■ 5 GHz—If the 5 GHz band is configured on the OAW-IAP, specify the minimum and maximum transmission rate. The default value for minimum transmission rate is 6 Mbps and maximum transmission rate is 54 Mbps.
Band	<p>Select a value to specify the band at which the network transmits radio signals. You can set the band to 2.4 GHz, 5 GHz, or All. The All option is selected by default.</p>
DTIM interval	<p>The DTIM interval indicates the DTIM period in beacons, which can be configured for every WLAN SSID profile. The DTIM interval determines how often the OAW-IAP should deliver the buffered broadcast and multicast frames to associated clients in the powersave mode. The default value is 1 beacon, which means the client checks for buffered data on the OAW-IAP at every beacon. You can also configure a higher DTIM value for power saving.</p>
Min RSSI for probe request	<p>Sets a minimum RSSI threshold for probe requests.</p>
Min RSSI for auth request	<p>Sets a minimum RSSI threshold for authentication requests.</p>

Table 32: WLAN Configuration Parameters

Parameter	Description
Very high throughput	Enables VHT function on OAW-IAP devices that support VHT. For 802.11ac OAW-IAPs, the VHT function is enabled by default. However, you can disable the VHT function if you want the 802.11ac OAW-IAPs to function as 802.11n OAW-IAPs. If VHT is configured or disabled on an SSID, the changes will apply only to the SSID on which it is enabled or disabled.
Zone	Specify the zone for the SSID. When the zone is defined in SSID profile and if the same zone is defined on an OAW-IAP, the SSID is created on that OAW-IAP. For more information on configuring zone details, see Configuring Zone Settings on an OAW-IAP on page 78 . The following constraints apply to the zone configuration: <ul style="list-style-type: none"> ■ An OAW-IAP can belong to only one zone and only one zone can be configured on an SSID. ■ If an SSID belongs to a zone, all OAW-IAPs in this zone can broadcast this SSID. If no OAW-IAP belongs to the zone configured on the SSID, the SSID is not broadcast. ■ If an SSID does not belong to any zone, all OAW-IAPs can broadcast this SSID.
Time Range	Click Edit , select a Time Range Profile from the list and specify if the profile must be enabled or disabled for the SSID, and then click OK .
Bandwidth Limits	Under Bandwidth Limits : <ul style="list-style-type: none"> ■ Airtime—Click the toggle switch and specify an aggregate amount of airtime that all clients in this network can use for sending and receiving data. Specify the airtime percentage. ■ Each radio—Click the toggle switch to specify an aggregate amount of throughput that each radio is allowed to provide for the connected clients. ■ Downstream and Upstream—Specify the downstream and upstream rates within a range of 1 to 65,535 Kbps for the SSID users. If the assignment is specific for each user, select the Peruser check box.
WMM	Configure the following options for WMM traffic management. WMM supports voice, video, best effort, and background access categories. To allocate bandwidth for the following types of traffic, specify a percentage value under Share . To configure DSCP mapping, specify a value under DSCP Mapping . <ul style="list-style-type: none"> ■ Background WMM—For background traffic such as file downloads or print jobs. ■ Best effort WMM—For best effort traffic such as traffic from legacy devices or traffic from applications or devices that do not support QoS. ■ Video WMM—For video traffic generated from video streaming. ■ Voice WMM—For voice traffic generated from the incoming and outgoing voice communication. For more information on WMM traffic and DSCP mapping, see WMM Traffic Management on page 370 .
	For voice traffic and Spectralink Voice Prioritization, configure the following parameters: <ul style="list-style-type: none"> ■ Traffic Specification (TSPEC)—To prioritize time-sensitive traffic such as voice traffic initiated by the client, Click the Traffic Specification (TSPEC) toggle switch. ■ TSPEC Bandwidth—To reserve bandwidth, set the TPSEC bandwidth to the desired value within the range of 200–600,000 Kbps. The default value is 2000 Kbps. ■ Spectralink Voice Protocol (SVP)—Click the toggle switch to prioritize voice traffic for SVP handsets.
Content filtering	Click the toggle switch to route all DNS requests for the non-corporate domains to OpenDNS on this network.
Inactivity timeout	Specify an interval for session timeout in seconds, minutes or hours. If a client session is inactive for the specified duration, the session expires and the users are required to log in again. You can specify a value within the range of 60-86,400 seconds or up to 24 hours for a client session. The default value is 1000 seconds.

Table 32: WLAN Configuration Parameters

Parameter	Description
Deauth inactive clients	Click the toggle switch to allow the OAW-IAP to send a deauthentication frame to the inactive client and clear client entry.
SSID	Select the Hide check box if you do not want the SSID (network name) to be visible to users. Select the Disable check box if you want to disable the SSID. On selecting this, the SSID will be disabled, but will not be removed from the network. By default, all SSIDs are enabled.
ESSID	Enter the ESSID. If the value defined for ESSID value is not the same as profile name, the SSIDs can be searched based on the ESSID value and not by its profile name.
Out of service (OOS)	Enable or disable the SSID based on the following out-of-service states of the OAW-IAP: <ul style="list-style-type: none"> ■ VPN down ■ Uplink down ■ Internet down ■ Primary uplink down The network will be out of service when selected event occurs and the SSID is enabled or disabled as per the configuration settings applied. For example, if you select the VPN down option from the drop-down list and set the status to enabled, the SSID is enabled when the VPN connection is down and is disabled when the VPN connection is restored.
OOS time (global)	Configure a hold time interval in seconds within a range of 30 to 300 seconds, after which the out-of-service operation is triggered. For example, if the VPN is down and the configured hold time is 45 seconds, the effect of this out-of-service state impacts the SSID availability after 45 seconds.
Max clients threshold	Specify the maximum number of clients that can be configured for each BSSID on a WLAN. You can specify a value within the range of 0 to 255. The default value is 64.
SSID Encoding	To encode the SSID, select UTF8. By default, the SSIDs are not encoded.
Deny inter user bridging	When enabled, the bridging traffic between two clients connected to the same SSID on the same VLAN is disabled. The clients can connect to the Internet, but cannot communicate with each other, and the bridging traffic between the clients is sent to the upstream device to make the forwarding decision.
Openflow	When enabled, users can run and manage multiple instances of the control-plane and dataplane from a centralized location. OpenFlow also ensures uniform policy enforcement.

8. Click **Next** to configure VLAN settings.

9. Under **VLAN** tab, In **Client IP assignment**, select any of the following options:

- **Virtual Controller managed**—On selecting this option, the client obtains the IP address from the virtual switch. When this option is used, the source IP address is translated to the physical IP address of the master OAW-IAP for all client traffic that goes through this interface. The virtual switch can also assign a guest VLAN to the client.
- **Network assigned**—On selecting this option, the IP address is obtained from the network.

10. Based on the type client IP assignment mode selected, you can configure the VLAN assignment for clients as described in the following table:

Table 33: IP and VLAN Assignment for WLAN SSID Clients

Client IP Assignment	Client VLAN Assignment
Virtual Controller managed	<p>If the Virtual Controller managed is selected for client IP assignment, the virtual switch creates a private subnet and VLAN on the OAW-IAP for the wireless clients. The NAT for all client traffic that goes out of this interface is carried out at the source. This setup eliminates the need for complex VLAN and IP address management for a multi-site wireless network. On selecting this option, the following client VLAN assignment options are displayed:</p> <ul style="list-style-type: none"> ■ Default: When selected, the default VLAN as determined by the virtual switch is assigned for clients. ■ Custom: When selected, you can specify a custom VLAN assignment option. You can select an existing DHCP scope for client IP and VLAN assignment or you can create a new DHCP scope by selecting New. For more information on DHCP scopes, see Configuring DHCP Scopes on page 276.
Network assigned	<p>If the Network assigned is selected, you can specify any of the following options for the Client VLAN assignment.</p> <ul style="list-style-type: none"> ■ Default—On selecting this option, the client obtains the IP address in the same subnet as the OAW-IAPs. By default, the client VLAN is assigned to the native VLAN on the wired network. ■ Static—On selecting this option, you need to specify a single VLAN, a comma separated list of VLANs, or a range of VLANs for all clients on this network. Select this option for configuring VLAN pooling. ■ Dynamic—On selecting this option, you can assign the VLANs dynamically from a DHCP server. To create VLAN assignment rules, click New to assign the user to a VLAN. In the New VLAN Assignment Rule window, enter the following information: <ul style="list-style-type: none"> ■ Attribute—Select an attribute returned by the RADIUS server during authentication. ■ Operator—Select an operator for matching the string. ■ String—Enter the string to match ■ VLAN—Enter the VLAN to be assigned.

11. Click **Next** to configure [internal](#) or [external captive portal authentication, roles, and access rules](#) for the guest users.



If the client IP assignment mode is set to **Network assigned** in a guest SSID profile, the guest clients can log out of the captive portal network by accessing the <https://securelogin.arubanetworks.com/auth/logout.html> URL.

In the CLI

To configure WLAN settings for an SSID profile:

```
(Instant AP) (config)# wlan ssid-profile <name>
(Instant AP) (SSID Profile <name>)# essid <ESSID-name>
(Instant AP) (SSID Profile <name>)# type <Guest>
(Instant AP) (SSID Profile <name>)# broadcast-filter <type>
(Instant AP) (SSID Profile <name>)# dtim-period <number-of-beacons>
(Instant AP) (SSID Profile <name>)# multicast-rate-optimization
(Instant AP) (SSID Profile <name>)# dynamic-multicast-optimization
(Instant AP) (SSID Profile <name>)# dmo-channel-utilization-threshold
(Instant AP) (SSID Profile <name>)# a-max-tx-rate <rate>
(Instant AP) (SSID Profile <name>)# a-min-tx-rate <rate>
(Instant AP) (SSID Profile <name>)# g-max-tx-rate <rate>
(Instant AP) (SSID Profile <name>)# g-min-tx-rate <rate>
(Instant AP) (SSID Profile <name>)# zone <zone>
(Instant AP) (SSID Profile <name>)# bandwidth-limit <limit>
(Instant AP) (SSID Profile <name>)# per-user-bandwidth-limit <limit>
(Instant AP) (SSID Profile <name>)# air-time-limit <limit>
(Instant AP) (SSID Profile <name>)# wmm-background-share <percentage-of-traffic_share>
(Instant AP) (SSID Profile <name>)# wmm-best-effort-share<percentage-of-traffic-share>
```

```
(Instant AP) (SSID Profile <name>)# wmm-video-share <percentage-of-traffic_share>
(Instant AP) (SSID Profile <name>)# wmm-voice-share <percentage-of-traffic_share>
(Instant AP) (SSID Profile <name>)# rf-band {<2.4>|<5.0>|<all>}
(Instant AP) (SSID Profile <name>)# content-filtering
(Instant AP) (SSID Profile <name>)# hide-ssid
(Instant AP) (SSID Profile <name>)# inactivity-timeout <interval>
(Instant AP) (SSID Profile <name>)# local-probe-req-thresh <threshold>
(Instant AP) (SSID Profile <name>)# max-clients-threshold <number-of-clients>
```

To manually assign VLANs for WLAN SSID users:

```
(Instant AP) (config)# wlan ssid-profile <name>
(Instant AP) (SSID Profile <name>)# vlan <vlan-ID>
```

To create a new VLAN assignment rule:

```
(Instant AP) (config)# wlan ssid-profile <name>
(Instant AP) (SSID Profile <name>)# set-vlan <attribute>{equals|not-equals|starts-with|ends-
with|contains|matches-regular-expression} <operator> <VLAN-ID>|value-of}
```

Configuring Wired Profile for Guest Access

You can configure wired settings for a wired profile by using the AOS-W Instant WebUI or the CLI.

In the Old WebUI

1. Click the **Wired** link under **More** on the AOS-W Instant main window. The **Wired** window is displayed.
2. Click **New** under **Wired Networks**. The **New Wired Network** window is displayed.
3. Click the **Wired Settings** tab and enter the following information:
 - a. **Name**—Specify a name for the profile.
 - b. **Primary Usage**—Select **Guest**.
 - c. **Speed/Duplex**—Ensure that appropriate values are selected for **Speed/Duplex**. Contact your network administrator if you need to assign speed and duplex parameters.
 - d. **POE**—Set **POE** to **Enabled** to enable PoE.
 - e. **Admin Status**—Ensure that an appropriate value is selected. The **Admin Status** indicates if the port is up or down.
 - f. **Content Filtering**—To ensure that all DNS requests to non-corporate domains on this wired network are sent to OpenDNS, select **Enabled** for **Content Filtering**.
 - g. **Uplink**—Select **Enabled** to configure uplink on this wired profile. If **Uplink** is set to **Enabled** and this network profile is assigned to a specific port, the port will be enabled as Uplink port. For more information on assigning a wired network profile to a port, see [Assigning a Profile to Ethernet Ports on page 142](#).
 - h. **Spanning Tree**—Select the **Spanning Tree** check box to enable STP on the wired profile. STP ensures that there are no loops in any bridged Ethernet network and operates on all downlink ports, regardless of forwarding mode. STP will not operate on the uplink port and is supported only on OAW-IAPs with three or more ports. By default Spanning Tree is disabled on wired profiles.
 - i. **Inactivity Timeout**—Specify the time out interval within the range of 60–86,400 seconds for inactive wired clients. The default interval is 1000 seconds.
4. Click **Next**. The VLAN tab details are displayed.
5. Enter the following information.
 - a. **Mode**—You can specify any of the following modes:
 - **Access**—Select this mode to allow the port to carry a single VLAN specified as the native VLAN.

- **Trunk**—Select this mode to allow the port to carry packets for multiple VLANs specified as allowed VLANs. In this mode, you can configure the native VLAN and the allowed VLAN.
- b. Specify any of the following values for **Client IP Assignment**:
- **Virtual Controller managed**: Select this option to allow the virtual switch to assign IP addresses to the wired clients. When the virtual switch assignment is used, the source IP address is translated to the physical IP address of the master OAW-IAP for all client traffic that goes through this interface. The virtual switch can also assign a guest VLAN to a wired client.
 - **Network assigned**: Select this option to allow the clients to receive an IP address from the network to which the virtual switch is connected. On selecting this option, the **New** button to create a VLAN is displayed. Create a new VLAN if required.
- c. If the **Trunk** mode is selected:
- Specify the **Allowed VLAN**, enter a list of comma separated digits or ranges: for example, 1,2,5 or 1–4, or all. The Allowed VLAN refers to the VLANs carried by the port in Access mode.
 - If the **Client IP Assignment** is set to **Network assigned**, specify a value for **Native VLAN**. A VLAN that does not have a VLAN ID tag in the frames is referred to as Native VLAN. You can specify a value within the range of 1–4093.
- d. If the **Access** mode is selected:
- If the **Client IP Assignment** is set to **Virtual Controller managed**, proceed to step 2.
 - If the **Client IP Assignment** is set to **Network assigned**, specify a value for **Access VLAN** to indicate the VLAN carried by the port in the **Access** mode.
6. **Client VLAN assignment**—You can specify any of the following options.
- **Default**—Select this option to set the default VLAN.
 - **Custom**—Select this option to configure a custom VLAN.
7. Click **Next** to configure [internal](#) or [external captive portal authentication, roles, and access rules](#) for the guest users.

In the New WebUI

1. Navigate to the **Configuration > Networks** page.
2. Under **Networks**, click **+**.
3. Under **Basic**, In the **Name** field enter a name that uniquely identifies the network.
4. In the **Type** drop-down list, select **Wired**.
5. Click the **Show advanced options** link at the bottom of the page. Specify the following parameters as required.
6. In the same section, configure the following parameters:
 - a. **Primary Usage**—Select **Guest**.
 - b. **Speed/Duplex**—Ensure that appropriate values are selected for **Speed/Duplex**. Contact your network administrator if you need to assign speed and duplex parameters.
 - c. **POE**—Set **POE** to **Enabled** to enable PoE.
 - d. **Admin Status**—Ensure that an appropriate value is selected. The **Admin Status** indicates if the port is up or down.
 - e. **Content Filtering**—To ensure that all DNS requests to non-corporate domains on this wired network are sent to OpenDNS, select **Enabled** for **Content Filtering**.
 - f. **Uplink**—Click the toggle switch to configure uplink on this wired profile. If **Uplink** is enabled and this network profile is assigned to a specific port, the port will be enabled as Uplink port. For more information on assigning a wired network profile to a port, see [Assigning a Profile to Ethernet Ports on page 142](#).

g. **Spanning Tree**—Click the **Spanning Tree** toggle switch to enable STP on the wired profile. STP ensures that there are no loops in any bridged Ethernet network and operates on all downlink ports, regardless of forwarding mode. STP will not operate on the uplink port and is supported only on OAW-IAPs with three or more ports. By default Spanning Tree is disabled on wired profiles.

h. **Inactivity Timeout**—Specify the time out interval within the range of 60–86,400 seconds for inactive wired clients. The default interval is 1000 seconds.

7. Click **Next** to configure VLAN settings.

8. Under **VLAN** configure the following:

a. **Mode**—You can specify any of the following modes:

- **Access**—Select this mode to allow the port to carry a single VLAN specified as the native VLAN.
- **Trunk**—Select this mode to allow the port to carry packets for multiple VLANs specified as allowed VLANs. In this mode, you can configure the native VLAN and the allowed VLAN.

b. Specify any of the following values for **Client IP Assignment**:

- **Virtual Controller managed**: Select this option to allow the virtual switch to assign IP addresses to the wired clients. When the virtual switch assignment is used, the source IP address is translated to the physical IP address of the master OAW-IAP for all client traffic that goes through this interface. The virtual switch can also assign a guest VLAN to a wired client.
- **Network assigned**: Select this option to allow the clients to receive an IP address from the network to which the virtual switch is connected. On selecting this option, the **New** button to create a VLAN is displayed. Create a new VLAN if required.

c. If the **Trunk** mode is selected:

- Specify the **Allowed VLANs**, enter a list of comma separated digits or ranges: for example, 1,2,5 or 1–4, or all. The Allowed VLAN refers to the VLANs carried by the port in Access mode.
- If the **Client IP Assignment** is set to **Network assigned**, specify a value for **Native VLAN**. A VLAN that does not have a VLAN ID tag in the frames is referred to as Native VLAN. You can specify a value within the range of 1–4093.

d. If the **Access** mode is selected:

- If the **Client IP Assignment** is set to **Virtual Controller assigned**, proceed to step 2.
- If the **Client IP Assignment** is set to **Network managed**, specify a value for **Access VLAN** to indicate the VLAN carried by the port in the **Access** mode.

9. **Client VLAN assignment**—You can specify any of the following options.

- **Default**—Select this option to set the default VLAN.
- **Custom**—Select this option to configure a custom VLAN.

10. Click **Next** to configure [internal](#) or [external captive portal authentication, roles, and access rules](#) for the guest users.

In the CLI

To configure the settings for the wired profile:

```
(Instant AP) (config)# wired-port-profile <name>
(Instant AP) (wired ap profile <name>)# type <guest>
(Instant AP) (wired ap profile <name>)# speed {10|100|1000|auto}
(Instant AP) (wired ap profile <name>)# duplex {half|full|auto}
(Instant AP) (wired ap profile <name>)# no shutdown
(Instant AP) (wired ap profile <name>)# poe
(Instant AP) (wired ap profile <name>)# uplink-enable
(Instant AP) (wired ap profile <name>)# content-filtering
(Instant AP) (wired ap profile <name>)# spanning-tree
```

To configure VLAN settings for a wired profile:

```
(Instant AP) (config)# wired-port-profile <name>
(Instant AP) (wired ap profile <name>)# switchport-mode {trunk|access}
(Instant AP) (wired ap profile <name>)# allowed-vlan <vlan>
(Instant AP) (wired ap profile <name>)# native-vlan {<guest|1...4095>}
```

To configure a new VLAN assignment rule:

```
(Instant AP) (config)# wired-port-profile <name>
(Instant AP) (wired ap profile <name>)# set-vlan <attribute>{equals|not-equals|starts-
with|ends-with|contains|matches-regular-expression} <operator> <VLAN-ID>|value-of}
```

IGMP

IP multicast is a network addressing method used to simultaneously deliver a single stream of information from a sender to multiple clients on a network. Unlike broadcast traffic which is meant for all the hosts on a single domain, multicast traffic is sent only to specific hosts that are configured to receive such traffic. Clients that want to receive multicast traffic can join a multicast group through IGMP messages.

- Alcatel-Lucent AOS-W Instant supports basic functionalities of IGMPv2 and IGMPv3 such as Multicast Group Join and Multicast Group Leave.
- Alcatel-Lucent AOS-W Instant does not support Source Filtering, Multicast Group Query, Proxy, or Snooping.
- IGMP is not active on wired ports.

Dynamic Multicast Optimization

DMO is an additional feature that is independent from IGMP, by converting multicast streams into unicast streams over a wireless link to enhance the quality and reliability of streaming videos, while preserving the bandwidth available to non-video clients. To configure this feature, refer to [Configuring WLAN Settings for an SSID Profile on page 101](#).

Multicast Transmission Optimization

Multicast transmission optimization is an additional feature that is independent from IGMP, wherein the OAW-IAP selects the optimal rate for sending 802.11 broadcast and multicast frames based on the lowest of unicast rates across all associated clients. To configure this feature, refer to [Configuring WLAN Settings for an SSID Profile on page 101](#).

Configuring Internal Captive Portal for Guest Network

For internal captive portal authentication, an internal server is used for hosting the captive portal service. You can configure internal captive portal authentication when adding or editing a guest network created for wireless or wired profile through the AOS-W Instant WebUI or the CLI.

In the Old WebUI

1. Navigate to the WLAN wizard or Wired window.
 - To configure internal captive portal authentication for a WLAN SSID, on the **Networks** tab, click **New** to create a new network profile or **edit** to modify an existing profile.
 - To configure internal captive portal authentication for a wired profile, click **More > Wired**. In the **Wired** window, click **New** under **Wired Networks** to create a new network profile, or click **Edit** to select and modify an existing profile.
2. Set **Primary usage** to **Guest**.
3. Click the **Security** tab and assign values for the configuration parameters:

Table 34: Internal Captive Portal Configuration Parameters

Parameter	Description
Splash page type	Select any of the following from the drop-down list. <ul style="list-style-type: none"> ■ Internal - Authenticated—When Internal Authenticated is enabled, the guest users are required to authenticate in the captive portal page to access the Internet. The guest users who are required to authenticate must already be added to the user database. ■ Internal - Acknowledged—When Internal Acknowledged is enabled, the guest users are required to accept the terms and conditions to access the Internet.
MAC authentication	Select Enabled from the Mac Authentication drop-down list to enable MAC authentication.
Delimiter character	Specify a character (for example, colon or dash) as a delimiter for the MAC address string. When configured, the OAW-IAP will use the delimiter in the MAC authentication request. For example, if you specify colon as the delimiter, MAC addresses in the xx:xx:xx:xx:xx:xx format are used. If the delimiter is not specified, the MAC address in the xxxxxxxxxxxx format is used. NOTE: This option is available only when MAC authentication is enabled.
Uppercase support	Set to Enabled to allow the OAW-IAP to use uppercase letters in MAC address string for MAC authentication. NOTE: This option is available only if MAC authentication is enabled.
WISPr (applicable for WLAN SSIDs only)	Select Enabled if you want to enable WISPr authentication. For more information on WISPr authentication, see Configuring WISPr Authentication on page 231 . NOTE: The WISPr authentication is applicable only for Internal-Authenticated splash pages and is not applicable for wired profiles.
Auth server 1 Auth server 2	Select any one of the following: <ul style="list-style-type: none"> ■ A server from the list of servers, if the server is already configured. ■ Internal Server to authenticate user credentials at run time. ■ Select New for configuring a new external RADIUS or LDAP server for authentication.
Load balancing	Select Enabled to enable load balancing if two authentication servers are used.
Reauth interval	Select a value to allow the OAW-IAPs to periodically reauthenticate all associated and authenticated clients.
Blacklisting (applicable for WLAN SSIDs only)	If you are configuring a wireless network profile, select Enabled to enable blacklisting of the clients with a specific number of authentication failures in the Max auth failures text box.
Accounting mode (applicable for WLAN SSIDs only)	Select an accounting mode from the Accounting mode drop-down list for posting accounting information at the specified accounting interval. When the accounting mode is set to Authentication , the accounting starts only after client authentication is successful and stops when the client logs out of the network. If the accounting mode is set to Association , the accounting starts when the client associates to the network successfully and stops when the client is disconnected.

Table 34: Internal Captive Portal Configuration Parameters

Parameter	Description
Accounting interval	Configure an accounting interval in minutes within the range of 0–60, to allow OAW-IAPs to periodically post accounting information to the RADIUS server.
Encryption (Applicable for WLAN SSIDs only)	Select Enabled to configure encryption parameters. Select an encryption and configure a passphrase.
Splash Page Visuals	<p>Under Splash Page Visuals, use the editor to specify display text and colors for the initial page that will be displayed to the users when they connect to the network. The initial page asks for user credentials or email, depending on the splash page type (Internal - Authenticated or Internal - Acknowledged).</p> <p>To customize the splash page design, perform the following steps:</p> <ul style="list-style-type: none"> ■ To change the color of the splash page, click the Splash page rectangle and select the required color from the Background Color palette. ■ To change the welcome text, click the first square box in the splash page, type the required text in the Welcome text box, and click OK. Ensure that the welcome text does not exceed 127 characters. ■ To change the policy text, click the second square box in the splash page, type the required text in the Policy text box, and click OK. Ensure that the policy text does not exceed 255 characters. ■ To upload a custom logo, click Upload your own custom logo Image, browse the image file, and click upload image. Ensure that the image file size does not exceed 16 KB. ■ To redirect users to another URL, specify a URL in Redirect URL. ■ Click Preview to preview the captive portal page. <p>NOTE: You can customize the captive portal page using double-byte characters. Traditional Chinese, Simplified Chinese, and Korean are a few languages that use double-byte characters. Click the banner, term, or policy in the Splash Page Visuals to modify the text in the red box. These fields accept double-byte characters or a combination of English and double-byte characters.</p>

4. Click **Next** to configure access rules.

In the New WebUI

To configure internal captive portal authentication for a WLAN SSID or a wired profile:

1. Navigate to the **Configuration > Networks** page.
 - To create a new network profile, click **+**.
 - To modify an existing profile, select the profile and click **edit**.
2. Under **Basic**, set **Primary usage** to **Guest**.
3. Select the **Security** tab and assign values for the configuration parameters:

Table 35: Internal Captive Portal Configuration Parameters

Parameter	Description
Splash page type	Select any of the following from the drop-down list. <ul style="list-style-type: none"> ■ Internal - Authenticated—When Internal Authenticated is enabled, the guest users are required to authenticate in the captive portal page to access the Internet. The guest users who are required to authenticate must already be added to the user database. ■ Internal - Acknowledged—When Internal Acknowledged is enabled, the guest users are required to accept the terms and conditions to access the Internet.
MAC authentication	Click the Mac Authentication toggle switch to enable MAC authentication.
Delimiter character	Specify a character (for example, colon or dash) as a delimiter for the MAC address string. When configured, the OAW-IAP will use the delimiter in the MAC authentication request. For example, if you specify colon as the delimiter, MAC addresses in the xx:xx:xx:xx:xx:xx format are used. If the delimiter is not specified, the MAC address in the xxxxxxxxxxxx format is used. NOTE: This option is available only when MAC authentication is enabled.
Uppercase support	Click the toggle switch to allow the OAW-IAP to use uppercase letters in MAC address string for MAC authentication. NOTE: This option is available only if MAC authentication is enabled.
WISPr (applicable for WLAN SSIDs only)	Click the toggle switch if you want to enable WISPr authentication. For more information on WISPr authentication, see Configuring WISPr Authentication on page 231 . NOTE: The WISPr authentication is applicable only for Internal-Authenticated splash pages and is not applicable for wired profiles.
Authentication server 1 Authentication server 2	Select any one of the following: <ul style="list-style-type: none"> ■ A server from the list of servers, if the server is already configured. ■ Internal Server to authenticate user credentials at run time. ■ Select + for configuring a new external RADIUS or LDAP server for authentication.
Load balancing	Click the toggle switch to enable load balancing if two authentication servers are used.
Reauth interval	Select a value to allow the OAW-IAPs to periodically reauthenticate all associated and authenticated clients.
Accounting	Select any of the following options from the Accounting drop-down list: <ul style="list-style-type: none"> ■ Disabled ■ Use authentication servers ■ Use separate servers
Accounting mode (applicable for WLAN SSIDs only)	Select an accounting mode from the Accounting mode drop-down list for posting accounting information at the specified accounting interval. When the accounting mode is set to Authentication , the accounting starts only after client authentication is successful and stops when the client logs out of the network. If the accounting mode is set to Association , the accounting starts when the client associates to the network successfully and stops when the client is disconnected. NOTE: This option is not available when Accounting is set to Disabled .

Table 35: Internal Captive Portal Configuration Parameters

Parameter	Description
Accounting interval	Configure an accounting interval in minutes within the range of 0–60, to allow OAW-IAPs to periodically post accounting information to the RADIUS server. NOTE: This option is not available when Accounting is set to Disabled .
Blacklisting (applicable for WLAN SSIDs only)	If you are configuring a wireless network profile, enable Blacklisting to enable blacklisting of the clients with a specific number of authentication failures in the Max auth failures text box.
Enforce DHCP	Click the toggle switch to enforce DHCP on OAW-IAP clients. For more information on enforcing DHCP settings, refer to Enforcing DHCP on page 111 .
Disable if uplink type is	To exclude uplink, select an uplink type.
Encryption (Applicable for WLAN SSIDs only)	Click the toggle switch to configure encryption parameters. Select an encryption from the Key management drop-down list and configure a passphrase from the Passphrase format drop-down list.
Splash Page Visuals	<p>Under Splash Page Visuals, use the editor to specify display text and colors for the initial page that will be displayed to the users when they connect to the network. The initial page asks for user credentials or email, depending on the splash page type (Internal - Authenticated or Internal - Acknowledged).</p> <p>To customize the splash page design, perform the following steps:</p> <ul style="list-style-type: none"> ■ To change the color of the splash page, click the Splash page rectangle and select the required color from the Background Color palette. ■ To change the welcome text, click the first square box in the splash page, type the required text in the Welcome text box, and click OK. Ensure that the welcome text does not exceed 127 characters. ■ To change the policy text, click the second square box in the splash page, type the required text in the Policy text box, and click OK. Ensure that the policy text does not exceed 255 characters. ■ To upload a custom logo, click Upload your own custom logo Image, browse the image file, and click upload image. Ensure that the image file size does not exceed 16 KB. ■ To redirect users to another URL, specify a URL in Redirect URL. ■ Click Preview to preview the captive portal page. <p>NOTE: You can customize the captive portal page using double-byte characters. Traditional Chinese, Simplified Chinese, and Korean are a few languages that use double-byte characters. Click the banner, term, or policy in the Splash Page Visuals to modify the text in the red box. These fields accept double-byte characters or a combination of English and double-byte characters.</p>

4. Click **Next** to configure access rules.

In the CLI

To configure internal captive portal authentication:

```
(Instant AP) (config)# wlan ssid-profile <name>
(Instant AP) (SSID Profile <name>)# essid <ESSID-name>
(Instant AP) (SSID Profile <name>)# type <Guest>
(Instant AP) (SSID Profile <name>)# captive-portal <internal-authenticated> exclude-uplink
{3G|4G|Wifi|Ethernet}
(Instant AP) (SSID Profile <name>)# mac-authentication
(Instant AP) (SSID Profile <name>)# auth-server <server1>
(Instant AP) (SSID Profile <name>)# radius-reauth-interval <Minutes>
```

To configure internal captive portal for a wired profile:

```
(Instant AP) (config)# wired-port-profile <name>
(Instant AP) (wired ap profile <name>)# type <guest>
(Instant AP) (wired ap profile <name>)# captive-portal {<internal-authenticated>|<internal-acknowledged>} exclude-uplink {3G|4G|Wifi|Ethernet}
(Instant AP) (wired ap profile <name>)# mac-authentication
(Instant AP) (wired ap profile <name>)# auth-server <server1>
(Instant AP) (wired ap profile <name>)# radius-reauth-interval <Minutes>
```

To customize internal captive portal splash page:

```
(Instant AP) (config)# wlan captive-portal
(Instant AP) (Captive Portal)# authenticated
(Instant AP) (Captive Portal)# background-color <color-indicator>
(Instant AP) (Captive Portal)# banner-color <color-indicator>
(Instant AP) (Captive Portal)# banner-text <text>
(Instant AP) (Captive Portal)# decoded-texts <text>
(Instant AP) (Captive Portal)# redirect-url <url>
(Instant AP) (Captive Portal)# terms-of-use <text>
(Instant AP) (Captive Portal)# use-policy <text>
```

To upload a customized logo from a TFTP server to the OAW-IAP:

```
(Instant AP)# copy config tftp <ip-address> <filename> portal logo
```

Configuring External Captive Portal for a Guest Network

This section provides the following information:

- [External Captive Portal Profiles on page 166](#)
- [Creating a Captive Portal Profile on page 166](#)
- [Configuring an SSID or Wired Profile to Use External Captive Portal Authentication on page 169](#)
- [External Captive Portal Redirect Parameters](#)

External Captive Portal Profiles

You can now configure external captive portal profiles and associate these profiles to a user role or SSID. You can create a set of captive portal profiles in the **External Captive Portal** window (accessed from the **Security** tab of the old WebUI and the **Configuration > Security** tab of the new WebUI) and associate these profiles with an SSID or a wired profile. You can also create a new captive portal profile on the **Security** tab of the WLAN wizard or a Wired Network window. In the current release, you can configure up to 16 external captive portal profiles.

When the captive portal profile is associated to an SSID, it is used before user authentication. If the profile is associated to a role, it is used only after the user authentication. When a captive portal profile is applied to an SSID or wired profile, the users connecting to the SSID or wired network are assigned a role with the captive portal rule. The guest user role allows only DNS and DHCP traffic between the client and the network, and directs all HTTP or HTTPS requests to the captive portal unless explicitly permitted to allow all types of traffic.

Creating a Captive Portal Profile

You can create a captive portal profile using the AOS-W Instant WebUI or the CLI.

In the Old WebUI

1. Go to **Security > External Captive Portal**.
2. Click **New**. The **New** popup window is displayed.
3. Specify values for the following parameters:

Table 36: Captive Portal Profile Configuration Parameters

Parameter	Description
Name	Enter a name for the profile.
Type	Select any one of the following types of authentication: <ul style="list-style-type: none"> ■ Radius Authentication—Select this option to enable user authentication against a RADIUS server. ■ Authentication Text—Select this option to specify an authentication text. The specified text will be returned by the external server after a successful user authentication.
IP or hostname	Enter the IP address or the host name of the external splash page server.
URL	Enter the URL for the external captive portal server.
Port	Enter the port number.
Use https (Available only if RADIUS Authentication is selected)	Select Enabled to enforce clients to use HTTPS to communicate with the captive portal server.
Captive Portal failure	Allows you to configure Internet access for the guest clients when the external captive portal server is not available. Select Deny Internet to prevent clients from using the network, or Allow Internet to allow the guest clients to access Internet when the external captive portal server is not available.
Automatic URL Whitelisting	Select Enabled to enable the automatic whitelisting of URLs. On selecting the check box for the external captive portal authentication, the URLs that are allowed for the unauthenticated users to access are automatically whitelisted. The automatic URL whitelisting is disabled by default.
Auth Text (Available only if Authentication Text is selected)	If the External Authentication splash page is selected, specify the authentication text to be returned by the external server after successful authentication.
Server Offload	Select Enabled to enable server offload. The server offload feature ensures that the non-browser client applications are not unnecessarily redirected to the external portal server and thereby reducing the load on the external captive portal server. The Server Offload option is Disabled by default.
Prevent frame overlay	When the Prevent frame overlay option is enabled, a frame can display a page only if it is in the same domain as the main page. This option is Disabled by default and can be used to prevent the overlay of frames.
Use VC IP in Redirect URL	Sends the IP address of the virtual switch in the redirection URL when external captive portal servers are used. This option is disabled by default.
Redirect URL	Specify a redirect URL if you want to redirect the users to another URL.

4. Click **OK**.

In the New WebUI

1. Navigate to **Configuration > Security** page.
2. Expand **External Captive Portal**.
3. Click **+**. The **New** popup window is displayed.
4. Specify values for the following parameters:

Table 37: Captive Portal Profile Configuration Parameters

Parameter	Description
Name	Enter a name for the profile.
Type	Select any one of the following types of authentication: <ul style="list-style-type: none"> ■ Radius Authentication—Select this option to enable user authentication against a RADIUS server. ■ Authentication Text—Select this option to specify an authentication text. The specified text will be returned by the external server after a successful user authentication.
IP or hostname	Enter the IP address or the host name of the external splash page server.
URL	Enter the URL for the external captive portal server.
Port	Enter the port number.
Use HTTPS (Available only if RADIUS Authentication is selected)	This toggle switch enables clients to use HTTPS to communicate with the captive portal server. This option is enabled by default.
Captive Portal failure	Allows you to configure Internet access for the guest clients when the external captive portal server is not available. Select Deny Internet to prevent clients from using the network, or Allow Internet to allow the guest clients to access Internet when the external captive portal server is not available.
Automatic URL Whitelisting	Click the toggle switch to enable the automatic whitelisting of URLs. When this option is enabled for the external captive portal authentication, the URLs that are allowed for the unauthenticated users to access are automatically whitelisted. The automatic URL whitelisting is disabled by default.
Auth Text (Available only if Authentication Text is selected)	If the External Authentication splash page is selected, specify the authentication text to be returned by the external server after successful authentication.
Server offload	Click the toggle switch to enable server offload. The server offload feature ensures that the non-browser client applications are not unnecessarily redirected to the external portal server and thereby reducing the load on the external captive portal server. The Server offload option is disabled by default.
Prevent frame overlay	When the Prevent frame overlay toggle switch is enabled, a frame can display a page only if it is in the same domain as the main page. This option is disabled by default and can be used to prevent the overlay of frames.
Use VC IP in Redirect URL	Sends the IP address of the virtual switch in the redirection URL when external captive portal servers are used. This toggle switch is disabled by default.
Redirect URL	Specify a redirect URL if you want to redirect the users to another URL.

5. Click **OK**.

In the CLI

To configure an external captive portal profile:

```
(Instant AP) (config)# wlan external-captive-portal [profile_name]
(Instant AP) (External Captive Portal)# server <server>
(Instant AP) (External Captive Portal)# port <port>
(Instant AP) (External Captive Portal)# url <url>
(Instant AP) (External Captive Portal)# https
```



```
(Instant AP) (External Captive Portal)# redirect-url <url>
(Instant AP) (External Captive Portal)# server-fail-through
(Instant AP) (External Captive Portal)# no auto-whitelist-disable
(Instant AP) (External Captive Portal)# server-offload
(Instant AP) (External Captive Portal)# switch-ip
(Instant AP) (External Captive Portal)# prevent-frame-overlay
(Instant AP) (External Captive Portal)# out-of-service-page <url>
```



The `out-of-service-page <url>` parameter configures the OAW-IAP to display a custom captive portal page when the internet uplink is down. This parameter can be configured only through the AOS-W Instant CLI.

Configuring an SSID or Wired Profile to Use External Captive Portal Authentication

You can configure external captive portal authentication when adding or editing a guest network profile using the AOS-W Instant WebUI or the CLI.

In the Old WebUI

1. Navigate to the WLAN wizard or Wired window.
- To configure external captive portal authentication for a WLAN SSID, on the **Networks** tab, click **New** to create a new network profile or **edit** to modify an existing profile.
- To configure external captive portal authentication for a wired profile, Go to **More** > **Wired**. In the **Wired** window, click **New** under **Wired Networks** to create a new network, or click **Edit** to select an existing profile.
2. On the **Security** tab, select **External** from the **Splash page type** drop-down list.
3. From the **Captive Portal Profile** drop-down list, select a profile. You can select and modify a default profile, or an already existing profile, or click **New** and [create a new profile](#).
4. Configure the following parameters based on the type of splash page you selected.

Table 38: External Captive Portal Configuration Parameters

Parameter	Description
Captive-portal proxy server	If required, configure a captive portal proxy server or a global proxy server to match your browser configuration by specifying the IP address and port number in the Captive-portal proxy server text box.
WISPr	Select Enabled if you want to enable WISPr authentication. For more information on WISPr authentication, see Configuring WISPr Authentication on page 231 . NOTE: The WISPr authentication is applicable only for the External and Internal-Authenticated splash pages and is not applicable for wired profiles.
MAC authentication	Select Enabled if you want to enable MAC authentication. For information on MAC authentication, see Configuring MAC Authentication for a Network Profile on page 225 .
Delimiter character	Specify a character (for example, colon or dash) as a delimiter for the MAC address string. When configured, the OAW-IAP will use the delimiter in the MAC authentication request. For example, if you specify colon as the delimiter, MAC addresses in the xx:xx:xx:xx:xx:xx format are used. If the delimiter is not specified, the MAC address in the xxxxxxxxxxxx format is used. NOTE: This option is available only when MAC authentication is enabled.
Uppercase support	Set to Enabled to allow the OAW-IAP to use uppercase letters in MAC address string for MAC authentication. NOTE: This option is available only if MAC authentication is enabled.

Table 38: External Captive Portal Configuration Parameters

Parameter	Description
Authentication server 1 and Authentication server 2	To configure an authentication server, select any of the following options: <ul style="list-style-type: none">■ If the server is already configured, select the server from the list.■ To create new external RADIUS server, select New. For more information, see Configuring an External Server for Authentication on page 198.
Reauth interval	Specify a value for the reauthentication interval at which the OAW-IAPs periodically reauthenticate all associated and authenticated clients.
Accounting mode	Select an accounting mode from the Accounting mode drop-down list for posting accounting information at the specified Accounting interval . When the accounting mode is set to Authentication , the accounting starts only after client authentication is successful and stops when the client logs out of the network. If the accounting mode is set to Association , the accounting starts when the client associates to the network successfully and stops when the client is disconnected.
Accounting interval	Configure an accounting interval in minutes within the range of 0–60, to allow OAW-IAPs to periodically post accounting information to the RADIUS server.
Blacklisting	If you are configuring a wireless network profile, select Enabled to enable blacklisting of the clients with a specific number of authentication failures.
Max auth failures	If you are configuring a wireless network profile and Blacklisting is enabled, specify the maximum number of authentication failures after which users who fail to authenticate must be dynamically blacklisted.
Disable if uplink type is	Select the type of the uplink to exclude.
Encryption	Select Enabled to configure encryption settings and specify the encryption parameters.

5. Click **Next** to continue and then click **Finish** to apply the changes.

In the New WebUI

To configure external captive portal authentication for a WLAN SSID or a wired profile:

1. Navigate to the **Configuration > Networks** page.
 - To create a new network profile, click **+**.
 - To modify an existing profile, select the profile and click **edit**.
2. Select the **Security** tab.
3. In the **Splash page type** drop-down list, select **External**.
4. From the **Captive Portal Profile** drop-down list, select a profile. You can select and modify a default profile, or add an already existing profile, or click **+** and [create a new profile](#).
5. Configure the following parameters based on the type of splash page you selected.

Table 39: External Captive Portal Configuration Parameters

Parameter	Description
Captive portal proxy server	If required, configure a captive portal proxy server or a global proxy server to match your browser configuration by specifying the IP address and port number in the Captive-portal proxy server text box.
WISPr (applicable for WLAN SSIDs only)	Click the toggle switch if you want to enable WISPr authentication. For more information on WISPr authentication, see Configuring WISPr Authentication on page 231 . NOTE: The WISPr authentication is applicable only for the External and Internal-Authenticated splash pages and is not applicable for wired profiles.
MAC authentication	Click the toggle switch to enable MAC authentication. For information on MAC authentication, see Configuring MAC Authentication for a Network Profile on page 225 .
Delimiter character	Specify a character (for example, colon or dash) as a delimiter for the MAC address string. When configured, the OAW-IAP will use the delimiter in the MAC authentication request. For example, if you specify colon as the delimiter, MAC addresses in the xx:xx:xx:xx:xx:xx format are used. If the delimiter is not specified, the MAC address in the xxxxxxxxxxxx format is used. NOTE: This option is available only when MAC authentication is enabled.
Uppercase support	When enabled, the OAW-IAP uses uppercase letters in MAC address string for MAC authentication. NOTE: This option is available only if MAC authentication is enabled. This option is enabled by default.
Authentication server 1 and Authentication server 2	To configure an authentication server, select any of the following options: <ul style="list-style-type: none"> ■ If the server is already configured, select the server from the list. ■ To create new external RADIUS server, select New. For more information, see Configuring an External Server for Authentication on page 198.
Reauth interval	Specify a value for the reauthentication interval at which the OAW-IAPs periodically reauthenticate all associated and authenticated clients.
Accounting	Select any of the following options from the Accounting drop-down list: <ul style="list-style-type: none"> ■ Disabled ■ Use authentication servers ■ Use separate servers
Accounting mode (applicable for WLAN SSIDs only)	Select an accounting mode from the Accounting mode drop-down list for posting accounting information at the specified Accounting interval . When the accounting mode is set to Authentication , the accounting starts only after client authentication is successful and stops when the client logs out of the network. If the accounting mode is set to Association , the accounting starts when the client associates to the network successfully and stops when the client is disconnected. NOTE: This option is not available when Accounting is set to Disabled .
Accounting interval	Configure an accounting interval in minutes within the range of 0–60, to allow OAW-IAPs to periodically post accounting information to the RADIUS server. NOTE: This option is not available when Accounting is set to Disabled .
Blacklisting	If you are configuring a wireless network profile, keep the Blacklisting toggle switch enabled to allow blacklisting of the clients with a specific number of authentication failures. This option is enabled by default.
Max auth failures	If you are configuring a wireless network profile and Blacklisting is enabled, specify the maximum number of authentication failures after which users who fail to authenticate must be dynamically blacklisted.

Table 39: External Captive Portal Configuration Parameters

Parameter	Description
Disable if uplink type is	Select the type of the uplink to exclude.
Encryption	Click the toggle switch to configure encryption settings and specify the encryption parameters.

6. Click **Next** until **Finish** to apply the changes.

In the CLI

To configure security settings for guest users of the WLAN SSID profile:

```
(Instant AP) (config)# wlan ssid-profile <name>
(Instant AP) (SSID Profile <name>)# essid <ESSID-name>
(Instant AP) (SSID Profile <name>)# type <Guest>
(Instant AP) (SSID Profile <name>)# captive-portal{<type>[exclude-uplink <types>]|external
[exclude-uplink <types>]| profile <name>[exclude-uplink <types>]]}
(Instant AP) (SSID Profile <name>)# captive-portal-proxy-server <IP> <port>
(Instant AP) (SSID Profile <name>)# blacklist
(Instant AP) (SSID Profile <name>)# mac-authentication
(Instant AP) (SSID Profile <name>)# max-authentication-failures <number>
(Instant AP) (SSID Profile <name>)# auth-server <server-name>
(Instant Access Point (SSID Profile <name>)# radius-accounting
(Instant Access Point (SSID Profile <name>)# radius-interim-accounting-interval
(Instant Access Point (SSID Profile <name>)# radius-accounting-mode {user-association|user-
authentication}
(Instant AP) (SSID Profile <name>)# wpa-passphrase <WPA_key>
(Instant AP) (SSID Profile <name>)# wep-key <WEP-key> <WEP-index>
```

To configure security settings for guest users of the wired profile:

```
(Instant AP) (config)# wired-port-profile <name>
(Instant AP) (wired ap profile <name>)# type <Guest>
(Instant AP) (wired ap profile <name>)# captive-portal{<type>[exclude-uplink <types>]|external
[exclude-uplink <types>]| profile <name>[exclude-uplink <types>]]}
(Instant AP) (wired ap profile <name>)# mac-authentication
```

External Captive Portal Redirect Parameters

If the external captive portal redirection is enabled on a network profile, OAW-IAP sends an HTTP response with the redirect URL to display the splash page and enforce captive portal authentication by clients. The HTTP response from the OAW-IAP includes the following parameters:

Table 40: External Captive Portal Redirect Parameters

Parameter	Example Value	Description
cmd	login	Type of operation
mac	34:02:86:c6:d2:3e	Client MAC address
ssid	guest-ecp-109	ESSID
ip	192.0.2.0	Client IP address

Table 40: External Captive Portal Redirect Parameters

Parameter	Example Value	Description
apname	9c:1c:12:cb:a2:90	OAW-IAP host name
apmac	9c:1c:12:cb:a2:90	OAW-IAP MAC address
vcname	instant-C8:1D:DA"	Virtual switchname
switchip	securelogin.arubanetworks.com	Captive portal domain used for external captive portal authentication
url	http://www.google.com/	original URL

Configuring External Captive Portal Authentication Using ClearPass Guest

You can configure AOS-W Instant to point to ClearPass Guest as an external captive portal server. With this configuration, the user authentication is performed by matching a string in the server response and that in the RADIUS server (either ClearPass Guest or a different RADIUS server).

Creating a Web Login Page in ClearPass Guest

The ClearPass Guest Visitor Management Appliance provides a simple and personalized UI through which operational staff can quickly and securely manage visitor network access. With ClearPass Guest, the users can have a controlled access to a dedicated visitor management user database. Through a customizable web portal, the administrators can easily create an account, reset a password, or set an expiry time for visitors. Visitors can be registered at reception and provisioned with an individual guest account that defines the visitor profile and the duration of their visit. By defining a web login page on the ClearPass Guest Visitor Management Appliance, you can provide a customized graphical login page for visitors accessing the network.

For more information on setting up the RADIUS web login page, refer to the *RADIUS Services* section in the *ClearPass Guest Deployment Guide*

Configuring RADIUS Server in the Old WebUI

To configure AOS-W Instant to point to ClearPass Guest as an external captive portal server:

1. Select the WLAN SSID for which you want to enable external captive portal authentication with ClearPass Policy Manager. You can also configure the RADIUS server when configuring a new SSID profile.
2. On the **Security** tab, select **External** from the **Splash page type** drop-down list.
3. Select **New** from the **Captive portal profile** drop-down list and update the following:
 - a. Enter the IP address of the ClearPass Guest server in the **IP or hostname** text box. Obtain the ClearPass Guest IP address from your system administrator.
 - b. Enter **/page_name.php** in the **URL** text box. This URL must correspond to the **Page Name** configured in the ClearPass Guest RADIUS Web Login page. For example, if the Page Name is **Alcatel-Lucent**, the URL should be **/Alcatel-Lucent.php** in the WebUI.
 - c. Enter the **Port** number (generally should be **80**). The ClearPass Guest server uses this port for HTTP services.
 - d. Click **OK**.
4. To create an external RADIUS server, select **New** from the **Auth server 1** drop-down list. For information on authentication server configuration parameters, see [Configuring an External Server for Authentication on page 198](#).
5. Click **Next** and then click **Finish**.

6. To verify, select the updated SSID in the **Networks** tab of the AOS-W Instant main window.
7. Open any browser and type any URL. AOS-W Instant redirects the URL to ClearPass Guest login page.
8. Log in to the network with the username and password specified while configuring the RADIUS server.

Configuring RADIUS Server in the New WebUI

To configure AOS-W Instant to point to ClearPass Guest as an external captive portal server:

1. Select the WLAN SSID for which you want to enable external captive portal authentication with ClearPass Policy Manager. You can also configure the RADIUS server when configuring a new SSID profile.

1. Navigate to the **Configuration > Networks** page.
2. Select the WLAN SSID profile from the **Networks** list and click **edit**.
3. Select the **Security** tab and select **External** from the **Splash page type** drop-down list.
4. Select **+** from the **Captive portal profile** drop-down list to create a captive portal profile, and configure the following:
 - a. In the **Name** text box, enter the name of the profile .
 - b. In the **Type** drop-down list, select the authentication type.
 - a. In the **IP or hostname** text box, enter the IP address of the ClearPass Guest server. Obtain the ClearPass Guest IP address from your system administrator.
 - b. In the **URL** text box enter **/page_name.php**. This URL must correspond to the **Page Name** configured in the ClearPass Guest RADIUS Web Login page. For example, if the Page Name is **Alcatel-Lucent**, the URL should be **/Alcatel-Lucent.php** in the WebUI.
 - c. Enter the **Port** number (generally should be **80**). The ClearPass Guest server uses this port for HTTP services.
 - d. Click **OK**.
5. To create an external RADIUS server, select **+** from the **Authentication server 1** drop-down list. For information on authentication server configuration parameters, see [Configuring an External Server for Authentication on page 198](#).
6. Click **Next** and until **Finish**.
7. To verify, connect the updated SSID.
8. Open any browser and type any URL. AOS-W Instant redirects the URL to ClearPass Guest login page.
9. Log in to the network with the username and password specified while configuring the RADIUS server.

Configuring RADIUS Attribute for ClearPass Policy Manager Server Load Balancing

Starting from AOS-W Instant 6.4.3.4-4.2.1.0, the administrators can configure a RADIUS server IP address as one of the parameters on ClearPass Policy Manager server for external captive portal user authentication. Configuring a RADIUS server attribute for guest user authentication allows the administrators to balance the load on the ClearPass Policy Manager servers.

When the RADIUS server IP address is configured under **Extra Fields** in the ClearPass Guest login page, the RADIUS server IP parameter is submitted to the server as part of the HTTP or HTTPS POST data when the guest users initiate an HTTP or HTTPS request. The OAW-IAP intercepts this information to perform the actual RADIUS authentication with the server IP defined in the POST message. For more information on guest registration customization on ClearPass Guest, refer to the *ClearPass Guest User Guide*.

Configuring Facebook Login

AOS-W Instant supports the Facebook Wi-Fi feature that allows the captive portal clients using a Facebook account to authenticate on an OAW-IAP. You can configure a guest network to use a customized Facebook

page as an external captive portal URL and allow the OAW-IAP to redirect clients to a Facebook page when it receives an HTTP request. The users can select the appropriate option to authenticate and access the Internet. By configuring the Facebook login feature, businesses can pair their network with the Facebook Wi-Fi service, so that the users logging into Wi-Fi hotspots are presented with a business page, before gaining access to the network.

The Facebook Wi-Fi integration with the OAW-IAP includes the following procedures:

- [Setting up a Facebook Page](#)
- [Configuring an SSID](#)
- [Configuring the Facebook Portal Page in the Old WebUI](#)
- [Accessing the Portal Page in the Old WebUI](#)

Setting up a Facebook Page

To enable integration with the OAW-IAP, ensure that you have a Facebook page created as a local business with a valid location.

- For more information on creating a Facebook page, see the online help available at <https://www.facebook.com/help>.
- For more information on setting up and using Facebook Wi-Fi service, see <https://www.facebook.com/help/126760650808045>.

Configuring an SSID

You can configure a guest network profile and enable Facebook login through the AOS-W Instant WebUI or the CLI.

In the Old WebUI

To enable Facebook login:

1. Navigate to **Networks > New** to create a new network profile.
2. Enter a name for the SSID.
3. Select **Guest** under **Primary usage**.
4. Configure other required parameters in the **WLAN Settings** and **VLAN** tabs.
5. On the **Security** tab, select **Facebook** from the **Splash page type** drop-down list.
6. Click **Next**. The **Access** tab contents are displayed.
7. Click **Finish**. The SSID with the Facebook option is created. After the SSID is created, the OAW-IAP automatically registers with Facebook. If the OAW-IAP registration is successful, the **Facebook configuration** link is displayed in the **Security** tab of the WLAN wizard.

In the New WebUI

To enable Facebook login:

1. Navigate to the **Configuration > Networks** page.
2. Under **Networks**, click **+**.
3. Enter a name for the SSID.
4. In the **Primary usage** drop-down list, select **Guest**.
5. Configure other required parameters under **Basic** and **VLAN** tabs.
6. Under **Security**, select **Facebook** from the **Splash page type** drop-down list.
7. Configure the required settings.
8. Click **Next** until **Finish**.

9. The SSID with the Facebook option is created. After the SSID is created, the OAW-IAP automatically registers with Facebook. If the OAW-IAP registration is successful, the **Facebook configuration** link is displayed in the **Security** tab of the WLAN wizard.

In the CLI

To configure an account for captive portal authentication:

```
(Instant AP) (config)# wlan ssid-profile <name>
(Instant AP) (SSID Profile <name>)# captive-portal {<type>[exclude-uplink <types>]|external
[exclude-uplink <types>]|profile <name>[exclude-uplink <types>]]}
```

Example

The following example configures a Facebook account for captive portal authentication:

```
(Instant AP) (config)# wlan ssid-profile guestNetwork
(Instant AP) (SSID Profile "guestNetwork")# captive-portal facebook
```

Configuring the Facebook Portal Page in the Old WebUI

To bind the virtual switch with the Facebook portal:

1. Open the SSID with the Facebook option enabled, navigate to the **Security** tab and click the **Facebook configuration** link. The Facebook page is displayed.



The **Facebook configuration** link is displayed only if the OAW-IAP is successfully registered with Facebook.

2. Log in with your Facebook credentials. The **Facebook Wi-Fi Configuration** page is displayed.
3. Select the Facebook page.
4. Under **Bypass Mode**, select any of the following options:
 - **Skip Check-in link**—When selected, the users are not presented with your business Facebook page, but are allowed to access the Internet by clicking the **Skip Check-in** link.
 - **Require Wi-Fi code**—When selected, the users are assigned a Wi-Fi code to gain access to the Facebook page.
5. Customize the session length and terms of service if required.
6. Click **Save Settings**.

Configuring the Facebook Portal Page in the New WebUI

To bind the virtual switch with the Facebook portal:

1. Open the SSID with the Facebook option enabled, navigate to the **Security** tab and click the **Facebook configuration** link. The Facebook page is displayed.



The **Facebook configuration** link is displayed only if the OAW-IAP is successfully registered with Facebook.

2. Log in with your Facebook credentials. The **Facebook Wi-Fi Configuration** page is displayed.
3. Select the Facebook page.
4. Under **Bypass Mode**, select any of the following options:
 - **Skip Check-in link**—When selected, the users are not presented with your business Facebook page, but are allowed to access the Internet by clicking the **Skip Check-in** link.
 - **Require Wi-Fi code**—When selected, the users are assigned a Wi-Fi code to gain access to the Facebook page.

5. Customize the session length and terms of service if required.
6. Click **Save Settings**.

Accessing the Portal Page in the Old WebUI

To access the portal page:

1. Connect to the SSID with the Facebook option enabled.
2. Launch a web browser. The browser opens the Facebook Wi-Fi page. If the Wi-Fi-code based login is enabled, the users are prompted to enter the Wi-Fi code. If the **Skip Check-in** link is displayed, click the link to skip checking in to the Facebook business page and proceed to access the Internet.
3. If you want to check in the business page, click **Check In** and provide your credentials. After checking in, click **Continue Browsing** to access the web page that was originally requested.

Accessing the Portal Page in the New WebUI

To access the portal page:

1. Connect to the SSID with the Facebook option enabled.
2. Launch a web browser. The browser opens the Facebook Wi-Fi page. If the Wi-Fi-code based login is enabled, the users are prompted to enter the Wi-Fi code. If the **Skip Check-in** link is displayed, click the link to skip checking in to the Facebook business page and proceed to access the Internet.
3. If you want to check in the business page, click **Check In** and provide your credentials. After checking in, click **Continue Browsing** to access the web page that was originally requested.

Configuring Guest Logon Role and Access Rules for Guest Users

For captive portal profile, you can create any the following types of roles:

- A pre-authenticated role—This role is assigned before the captive portal authentication. The user can only access certain destinations with this role.
- A guest role—This role is assigned after user authentication.
- A captive-portal role—This role can be assigned to any network such as Employee, Voice, or Guest. When the user is assigned with this role, a splash page is displayed after opening a browser and the users may need to authenticate.

You can configure up to 128 access rules for guest user roles through the AOS-W Instant WebUI or the CLI.

In the Old WebUI

To configure roles and access rules for the guest network:

1. On the **Networks > Access** tab, set the slider to any of the following types of access control:
 - **Unrestricted**—Select this to set unrestricted access to the network.
 - **Network-based**—Set the slider to **Network-based** to set common rules for all users in a network. The **Allow any to all destinations** access rule is enabled by default. This rule allows traffic to all destinations. To define an access rule:
 - a. Click **New**.
 - b. Select appropriate options in the **New Rule** window.
 - c. Click **OK**.
 - **Role-based**—Select **Role-based** to enable access based on user roles.

For role-based access control:

- Create a user role if required. For more information, see [Configuring User Roles](#).
- Create access rules for a specific user role. For more information, see [Configuring ACL Rules for Network Services on page 240](#). You can also configure an access rule to enforce captive portal authentication for an SSID with the 802.1X authentication method. For more information, see [Configuring Captive Portal Roles for an SSID on page 179](#).
- Create a role assignment rule. For more information, see [Configuring Derivation Rules on page 264](#). AOS-W Instant supports role derivation based on the DHCP option for captive portal authentication. When the captive portal authentication is successful, a new user role is assigned to the guest users based on DHCP option configured for the SSID profile instead of the pre-authenticated role.

2. Click **Finish**.

In the New WebUI

To configure roles and access rules for the guest network:

1. Navigate to the **Configuration > Networks** and select the guest network you want to configure and click **edit**.
2. Select the **Access** tab, select any of the following types of access control from the **Access Rules** drop-down list:
 - **Unrestricted**—Select this to set unrestricted access to the network.
 - **Network-based**—Select this to set common rules for all users in a network. The **Allow any to all destinations** access rule is enabled by default. This rule allows traffic to all destinations. To define an access rule:
 - a. Click **+**.
 - b. Select appropriate options in the **New rule** window.
 - c. Click **OK**.
 - **Role-based**—Select this to enable access based on user roles.

For role-based access control:

- Create a user role if required. For more information, see [Configuring User Roles](#).
- Create access rules for a specific user role. For more information, see [Configuring ACL Rules for Network Services on page 240](#). You can also configure an access rule to enforce captive portal authentication for an SSID with the 802.1X authentication method. For more information, see [Configuring Captive Portal Roles for an SSID on page 179](#).
- Create a role assignment rule. For more information, see [Configuring Derivation Rules on page 264](#). AOS-W Instant supports role derivation based on the DHCP option for captive portal authentication. When the captive portal authentication is successful, a new user role is assigned to the guest users based on DHCP option configured for the SSID profile instead of the pre-authenticated role.

3. Click **Finish**.

In the CLI

To configure access control rules for a WLAN SSID:

```
(Instant AP) (config)# wlan access-rule <name>
(Instant AP) (Access Rule <name>)# rule <dest> <mask> <match> {<protocol> <start-port> <end-
port> {permit|deny|src-nat|dst-nat{<IP-address> <port>|<port>}}| app <app> {permit|deny}|
appcategory <appgrp>|webcategory <webgrp> {permit|deny}|webreputation <webrep>
[<option1...option9>]
```

To configure access control rules based on the SSID:

```
(Instant AP) (config)# wlan ssid-profile <name>
(Instant AP) (SSID Profile <name>)# set-role-by-ssid
```

To configure role assignment rules:

```
(Instant AP) (config)# wlan ssid-profile <name>
(Instant AP) (SSID Profile <name>)# set-role <attribute>{{equals|not-equals|starts-with|ends-
with|contains|matches-regular-expression}<operator><role>|value-of}
```

To configure a pre-authentication role:

```
(Instant AP) (config)# wlan ssid-profile <name>
(Instant AP) (SSID Profile <name>)# set-role-pre-auth <role>
```

To configure machine and user authentication roles:

```
(Instant AP) (config)# wlan ssid-profile <name>
(Instant AP) (SSID Profile <name>)# set-role-machine-auth <machine_only> <user_only>
```

To configure unrestricted access:

```
(Instant AP) (config)# wlan ssid-profile <name>
(Instant AP) (SSID Profile <name>)# set-role-unrestricted
```

Example

The following example configures access rules for the wireless network:

```
(Instant AP) (config)# wlan access-rule WirelessRule
```

Configuring Captive Portal Roles for an SSID

You can configure an access rule to enforce captive portal authentication for SSIDs that use 802.1X authentication to authenticate clients. You can configure rules to provide access to external or internal captive portal, so that some of the clients using this SSID can derive the captive portal role.

The following conditions apply to the 802.1X and captive portal authentication configuration:

- If a user role does not have captive portal settings configured, the captive portal settings configured for an SSID are applied to the client's profile.
- If the SSID does not have captive portal settings configured, the captive portal settings configured for a user role are applied to the client's profile.
- If captive portal settings are configured for both SSID and user role, the captive portal settings configured for a user role are applied to the client's profile.

You can create a captive portal role for both **Internal** and **External** splash page types.

To enforce the captive portal role, use the WebUI or the CLI.

In the Old WebUI

To create a captive portal role:

1. Select an SSID profile from the **Networks** tab and click **edit**. The **Edit <WLAN-Profile>** window is displayed.
2. On the **Access** tab, move the slider to **Role-based** access control by using the scroll bar.
3. Select a role or create a new one if required.
4. In the **Access Rules** window, click **New** to add a new rule. The **New Rule** window is displayed.
5. In the **New Rule** window, specify the parameters.

Table 41: Captive Portal Rule Configuration Parameters

Parameter	Description
Rule type	Select Captive Portal from the RuleType drop-down list.
Splash Page Type	Select any of the following attributes: <ul style="list-style-type: none"> ■ Select Internal to configure a rule for internal captive portal authentication. ■ Select External to configure a rule for external captive portal authentication.
Internal	If Internal is selected as splash page type, perform the following steps: <ul style="list-style-type: none"> ■ Under Splash Page Visuals, use the editor to specify display text and colors for the initial page that would be displayed to users connecting to the network. The initial page asks for user credentials or email, depending on the splash page type configured. ■ To change the color of the splash page, click the Splash page rectangle and select the required color from the Background Color palette. ■ To change the welcome text, click the first square box in the splash page, type the required text in the Welcome text box, and then click OK. Ensure that the welcome text does not exceed 127 characters. ■ To change the policy text, click the second square box in the splash page, type the required text in the Policy text box, and click OK. Ensure that the policy text does not exceed 255 characters. ■ Specify the URL to which you want to redirect the guest users. ■ To upload a custom logo, click Upload your own custom logo image, browse the image file, and click upload image. ■ To preview the captive portal page, click Preview.
External	If External is selected, perform the following steps: <ul style="list-style-type: none"> ■ Select a profile from the Captive portal profile drop-down list. ■ If you want to edit the profile, click Edit and update the following parameters: <ul style="list-style-type: none"> ■ Type—Select either Radius Authentication (to enable user authentication against a RADIUS server) or Authentication Text (to specify the authentication text to be returned by the external server after a successful user authentication). ■ IP or hostname— Enter the IP address or the host name of the external splash page server. ■ URL— Enter the URL for the external splash page server. ■ Port—Enter the port number. ■ Use https—Select Enabled to enforce clients to use HTTPS to communicate with the captive portal server. This option is available only if RADIUS Authentication is selected ■ Redirect URL—Specify a redirect URL if you want to redirect the users to another URL. ■ Captive Portal failure—The Captive Portal failure drop-down list allows you to configure Internet access for the guest clients when the external captive portal server is not available. Select Deny Internet to prevent clients from using the network, or Allow Internet to allow the guest clients to access Internet when the external captive portal server is not available. ■ Automatic URL Whitelisting—Select Enabled or Disabled to enable or disable automatic whitelisting of URLs. On selecting the check box for the external captive portal authentication, the URLs allowed for the unauthenticated users to access are automatically whitelisted. The automatic URL whitelisting is disabled by default.

Table 41: Captive Portal Rule Configuration Parameters

Parameter	Description
	<ul style="list-style-type: none"> ■ Server Offload—Select Enabled to enable server offload. The server offload feature ensures that the non-browser client applications are not unnecessarily redirected to the external portal server and thereby reducing the load on the external captive portal server. The Server Offload option is Disabled by default. ■ Prevent frame overlay—When the Prevent frame overlay option is enabled, a frame can display a page only if it is in the same domain as the main page. This option is Enabled by default and can be used to prevent the overlay of frames. ■ Use VC IP in Redirect URL—Sends the IP address of the virtual switch in the redirection URL when external captive portal servers are used. This option is disabled by default. ■ Auth Text—Indicates the authentication text returned by the external server after a successful user authentication.

6. Click **OK**. The enforce captive portal rule is created and listed as an access rule.
7. Create a role assignment rule based on the user role to which the captive portal access rule is assigned. Click **OK**.
8. Click **Finish**.

The client can connect to this SSID after authenticating with username and password. After a successful user login, the captive portal role is assigned to the client.

In the New WebUI

To create a captive portal role:

1. Navigate to the **Configuration > Networks** page.
2. Select a guest SSID profile and click **edit**
3. select the **Access** tab, select **Role-based** from the Access Rules drop-down list.
4. Select a role or create a new one if required.
5. In the **Access Rules for <network>** window, click **+** to add a new rule. The **New rule** window is displayed.
6. In the **New rule** window, specify the parameters.

Table 42: Captive Portal Rule Configuration Parameters

Parameter	Description
Rule type	Select Captive Portal from the RuleType drop-down list.
Splash Page Type	Select any of the following attributes: <ul style="list-style-type: none"> ■ Select Internal to configure a rule for internal captive portal authentication. ■ Select External to configure a rule for external captive portal authentication.
Internal	If Internal is selected as splash page type, perform the following steps: <ul style="list-style-type: none"> ■ Under Splash Page Visuals, use the editor to specify display text and colors for the initial page that would be displayed to users connecting to the network. The initial page asks for user credentials or email, depending on the splash page type configured.

Table 42: Captive Portal Rule Configuration Parameters

Parameter	Description
	<ul style="list-style-type: none"> ■ To change the color of the splash page, click the Splash page rectangle and select the required color from the Background Color palette. ■ To change the welcome text, click the first square box in the splash page, type the required text in the Welcome text box, and then click OK. Ensure that the welcome text does not exceed 127 characters. ■ To change the policy text, click the second square box in the splash page, type the required text in the Policy Text text box, and click OK. Ensure that the policy text does not exceed 255 characters. ■ Specify the URL to which you want to redirect the guest users. ■ To upload a custom logo, click Upload, browse the image file, and click Upload. ■ To preview the captive portal page, click Preview.
<p>External</p>	<p>If External is selected, perform the following steps:</p> <ul style="list-style-type: none"> ■ Select a profile from the Captive portal profile drop-down list. ■ If you want to edit the profile, click + and update the following parameters: <ul style="list-style-type: none"> ■ Type—Select either Radius Authentication (to enable user authentication against a RADIUS server) or Authentication Text (to specify the authentication text to be returned by the external server after a successful user authentication). ■ IP or hostname— Enter the IP address or the host name of the external splash page server. ■ URL— Enter the URL for the external splash page server. ■ Port—Enter the port number. ■ Use https—Click the toggle switch to use HTTPS to communicate with the captive portal server. This option is available only if RADIUS Authentication is selected ■ Redirect URL—Specify a redirect URL if you want to redirect the users to another URL. ■ Captive Portal failure—The Captive Portal failure drop-down list allows you to configure Internet access for the guest clients when the external captive portal server is not available. Select Deny Internet to prevent clients from using the network, or Allow Internet to allow the guest clients to access Internet when the external captive portal server is not available. ■ Automatic URL Whitelisting—Click the toggle switch accordingly based on whether you want to enable or disable automatic whitelisting of URLs. When enabled, the URLs allowed for the unauthenticated users to access are automatically whitelisted. This option is disabled by default. ■ Server Offload—Click the toggle switch to enable server offload. The server offload feature ensures that the non-browser client applications are not unnecessarily redirected to the external portal server and thereby reducing the load on the external captive portal server. The Server Offload toggle switch is disabled by default. ■ Prevent frame overlay—When the Prevent frame overlay toggle switch is clicked, a frame can display a page only if it is in the same domain as the main page. This option is enabled by default and can be used to prevent the overlay of frames. ■ Use VC IP in Redirect URL—Sends the IP address of the virtual switch in the redirection URL when external captive portal servers are used. This option is disabled by default. ■ Auth Text—Indicates the authentication text returned by the external server after a successful user authentication.

7. Click **OK**. The **Enforce captive portal** rule is created and listed as an access rule in the **Access Rules** window.
8. In the **Role Assignment Rules** window, click **+** to create a role assignment rule based on the user role to which the captive portal access rule is assigned. Click **OK**.
9. Click **Finish**.

The client can connect to this SSID after authenticating with username and password. After a successful user login, the captive portal role is assigned to the client.

In the CLI

To create a captive portal role:

```
(Instant AP) (config)# wlan access-rule <Name>
(Instant AP) (Access Rule <Name>)# captive-portal {external [profile <name>]|internal}
```

Configuring Walled Garden Access

On the Internet, a walled garden typically controls access to web content and services. The walled garden access is required when an external captive portal is used. For example, a hotel environment where the unauthenticated users are allowed to navigate to a designated login page (for example, a hotel website) and all its contents.

The users who do not sign up for the Internet service can view the allowed websites (typically hotel property websites). The website names must be DNS-based and support the option to define wildcards. When a user attempts to navigate to other websites that are not in the whitelist of the walled garden profile, the user is redirected to the login page. OAW-IAP supports walled garden only for the HTTP requests. For example, if you add yahoo.com in walled garden whitelist and the client sends an HTTPS request (https://yahoo.com), the requested page is not displayed and the users are redirected to the captive portal login page.

In addition, a blacklisted walled garden profile can also be configured to explicitly block the unauthenticated users from accessing some websites.

You can create a walled garden access in the CLI.

In the CLI

```
(Instant AP) (config)# wlan walled-garden
(Instant AP) (Walled Garden)# white-list <domain>
(Instant AP) (Walled Garden)# black-list <domain>
```

Disabling Captive Portal Authentication

You can disable a captive portal authentication by using the AOS-W Instant WebUI.

In the Old WebUI

To disable captive portal authentication:

1. Select a wireless guest or a wired guest profile. Depending on the network profile selected, the **Edit <WLAN-Profile>** or **Edit Wired Network** window is displayed.



You can also customize splash page visuals on the **Security** tab of **New WLAN** (WLAN wizard) and **New Wired Network** (wired profile window) when configuring a new profile.

2. Navigate to the **Security** tab.

3. Select **None** from the **Splash page type** drop-down list. Although the splash page is disabled, you can enable MAC authentication, configure authentication servers, set accounting parameters, blacklist clients based on MAC authentication failures, and configure encryption keys for authorized access.
4. If required, configure the security parameters.
5. Click **Next** and then click **Finish** to apply the changes.

In the New WebUI

To disable captive portal authentication:

1. Navigate to the **Configuration > Networks** tab.
2. Select a wireless guest or a wired guest profile and click **Edit**.



You can also customize splash page visuals on the **Configuration > Networks > Security** tab of the wireless or wired wizard when configuring a new profile.

3. Select the **Security** tab.
4. Select **None** from the **Splash page type** drop-down list. Although the splash page is disabled, you can enable MAC authentication, configure authentication servers, set accounting parameters, blacklist clients based on MAC authentication failures, and configure encryption keys for authorized access.
5. If required, configure the security parameters.
6. Click **Next** and until **Finish** to apply the changes.

This chapter provides the following information:

- [Managing OAW-IAP Users on page 185](#)
- [Supported Authentication Methods on page 190](#)
- [Supported EAP Authentication Frameworks on page 192](#)
- [Configuring Authentication Servers on page 193](#)
- [Understanding Encryption Types on page 212](#)
- [Configuring Authentication Survivability on page 213](#)
- [Configuring 802.1X Authentication for a Network Profile on page 216](#)
- [Enabling 802.1X Supplicant Support on page 223](#)
- [Configuring MAC Authentication for a Network Profile on page 225](#)
- [Configuring MAC Authentication with 802.1X Authentication on page 228](#)
- [Configuring MAC Authentication with Captive Portal Authentication on page 230](#)
- [Configuring WISPr Authentication on page 231](#)
- [Blacklisting Clients on page 232](#)
- [Uploading Certificates on page 235](#)

Managing OAW-IAP Users

The OAW-IAP users can be classified as follows:

- Administrator—An admin user who creates SSIDs, wired profiles, and DHCP server configuration parameters; and manages the local user database. The admin users can access the virtual switch Management UI.
- Guest administrator—A guest interface management user who manages guest users added in the local user database.
- Administrator with read-only access—The read-only admin user does not have access to the AOS-W Instant CLI. The WebUI will be displayed in the read-only mode for these users.
- Employee users—Employees who use the enterprise network for official tasks.
- Guest users—Visiting users who temporarily use the enterprise network to access the Internet.

The user access privileges are determined by OAW-IAP management settings in the OmniVista 3600 Air Manager Management client, and the type of the user. The following table outlines the access privileges defined for the admin user, guest management interface admin, and read-only users.

Table 43: User Privileges

User Category	AMP in Management Mode	OAW-IAP in Monitor Mode or without AMP
administrator	Access to local user database only	Complete access to the OAW-IAP
read-only administrator	No write privileges	No write privileges
guest administrator	Access to local user database only	Access to local user database only

Configuring OAW-IAP Users

The AOS-W Instant user database consists of a list of guest and employee users. The addition of a user involves specifying the login credentials for a user. The login credentials for these users are provided outside the AOS-W Instant system.

A guest user can be a visitor who is temporarily using the enterprise network to access the Internet. However, if you do not want to allow access to the internal network and the Intranet, you can segregate the guest traffic from the enterprise traffic by creating a guest WLAN and specifying the required authentication, encryption, and access rules.

An employee user is the employee who is using the enterprise network for official tasks. You can create Employee WLANs, specify the required authentication, encryption and access rules, and allow the employees to use the enterprise network.



The user database is also used when an OAW-IAP is configured as an internal RADIUS server.

The local user database of OAW-IAPs can support up to 512 user entries.

In the Old WebUI

To add a new user:

1. Click the **Security** link located directly above the Search bar in the AOS-W Instant main window.
2. Click **Users for Internal Server**, to view the contents of the **Users for Internal Server** tab.
3. Enter the user name in the **Username** text box.
4. Enter the password in the **Password** text box and reconfirm.
5. Select the type of network from the **Type** drop-down list.
6. Click **Add** and click **OK**. The users are listed in the **Users** list.

Edit or Delete User Settings

1. To edit user settings:
 - a. Select the user you want to modify from the **Users** list in the table.
 - b. Click **Edit** to modify user settings.
 - c. Click **OK**.

2. To delete a user:
 - a. Select the user you want to delete from the **Users** list in the table.
 - b. Click **Delete**.
3. To delete all or multiple users at a time, click **Delete All**.



Deleting a user only removes the user record from the user database, and will not disconnect the online user associated with the user name.

In the New WebUI

To add a new user:

1. Navigate to the **Configuration > Security** page.
2. Expand **Users**.
3. Under **Users** click **+** to add a new user.
4. In the **Add new user** window, update the user name, password, and select the type of user from the **Type** drop-down list.
5. Click **OK**.

Edit or Delete User Settings

1. To edit user settings:
 - a. Select the user you want to modify from the **Users** list in the table and click **Edit**.
 - b. Make the necessary changes to the user profile.
 - c. Click **OK**.
2. To delete a user, select the user you want to delete from the **Users** list in the table and click **Delete**.
3. To delete all or multiple users at a time, click **Delete All**.



Deleting a user only removes the user record from the user database, and will not disconnect the online user associated with the user name.

In the CLI

To configure an employee user:

```
(Instant AP) (config)# user <username> <password> radius
```

To configure a guest user:

```
(Instant AP) (config)# user <username> <password> portal
```

Configuring Authentication Parameters for Management Users

You can configure RADIUS or TACACS authentication servers to authenticate and authorize the management users of an OAW-IAP. The authentication servers determine if the user has access to administrative interface. The privilege level for different types of management users is defined on the RADIUS or TACACS server instead of the OAW-IAP. The OAW-IAPs map the management users to the corresponding privilege level and provide access to the users based on the attributes returned by the RADIUS or TACACS server.

You can configure authentication parameters for local admin, read-only, and guest management administrator account settings through the WebUI or the CLI.

In the Old WebUI

1. Navigate to **System > Admin**.

Table 44: Authentication Parameters for Management Users

Type of User	Authentication Options	Steps to Follow
Local	Internal	Select Internal if you want to specify a single set of user credentials. If using an internal authentication server: <ol style="list-style-type: none"> 1. Specify the Username and Password. 2. Retype the password to confirm.
	Authentication server	Select the RADIUS or TACACS authentication servers. You can also create a new server by selecting New from the Auth server 1 drop-down list. <ul style="list-style-type: none"> ■ Authentication server w/ fallback to internal— Select this option if you want to use both internal and external servers. When enabled, the authentication switches to Internal if there is no response from the RADIUS server (RADIUS server timeout). To use this option, select the authentication servers and configure the user credentials for internal-server-based authentication. ■ Load balancing—If two servers are configured, users can use them in the primary or backup mode, or load balancing mode. To enable load balancing, select Enabled from the Load balancing drop-down list. For more information on load balancing, see Dynamic Load Balancing between Two Authentication Servers on page 198. ■ TACACS accounting—If a TACACS server is selected, enable TACACS accounting to report management commands if required.
View Only	Internal	Select Internal to specify a single set of user credentials. If using an internal authentication server: <ol style="list-style-type: none"> 1. Specify the Username and Password. 2. Retype the password to confirm.
	Authentication server	If a RADIUS or TACACS server is configured, select Authentication server for authentication.
Guest Registration Only	Internal	Select Internal to specify a single set of user credentials. If using an internal authentication server: <ol style="list-style-type: none"> 1. Specify the Username and Password. 2. Retype the password to confirm.
	Authentication server	If a RADIUS or TACACS server is configured, select Authentication server for authentication.

3. Click **OK**.

In the New WebUI

1. Navigate to the **Configuration > System** page.
2. Expand **Admin**.

Table 45: Authentication Parameters for Management Users

Type of User	Authentication Options	Steps to Follow
Local	Internal	Select Internal if you want to specify a single set of user credentials. If using an internal authentication server: <ol style="list-style-type: none"> 1. Specify the Username and Password. 2. Retype the password to confirm.
	Authentication server	Select the RADIUS or TACACS authentication servers. You can also create a new server by selecting + from the Auth server 1 drop-down list. <ul style="list-style-type: none"> ■ Authentication server w/ fallback to internal— Select this option if you want to use both internal and external servers. When enabled, the authentication switches to Internal if there is no response from the RADIUS server (RADIUS server timeout). To use this option, select the authentication servers and configure the user credentials for internal-server-based authentication. ■ Load balancing—If two servers are configured, users can use them in the primary or backup mode, or load balancing mode. To enable load balancing, select Enabled. For more information on load balancing, see Dynamic Load Balancing between Two Authentication Servers on page 198. ■ TACACS accounting—If a TACACS server is selected, click the TACACS accounting toggle switch to report management commands, if required.
View Only	Internal	Select Internal to specify a single set of user credentials. If using an internal authentication server: <ol style="list-style-type: none"> 1. Specify the Username and Password. 2. Retype the password to confirm.
	Authentication server	If a RADIUS or TACACS server is configured, select Authentication server for authentication.
Guest Registration Only	Internal	Select Internal to specify a single set of user credentials. If using an internal authentication server: <ol style="list-style-type: none"> 1. Specify the Username and Password. 2. Retype the password to confirm.
	Authentication server	If a RADIUS or TACACS server is configured, select Authentication server for authentication.

3. Click **Save**.

In the CLI

To configure a local admin user:

```
(Instant AP) (config)# mgmt-user <username> [password]
```

To configure guest management administrator credentials:

```
(Instant AP) (config)# mgmt-user <username> [password] guest-mgmt
```

To configure a user with read-only privilege:

```
(Instant AP) (config)# mgmt-user <username> [password] read-only
```

To configure management authentication settings:

```
(Instant AP) (config)# mgmt-auth-server <server1>
```

```
(Instant AP) (config)# mgmt-auth-server <server2>
```

```
(Instant AP) (config)# mgmt-auth-server-load-balancing
(Instant AP) (config)# mgmt-auth-server-local-backup
```

To enable TACACS accounting:

```
(Instant AP) (config)# mgmt-accounting command all
```

Adding Guest Users through the Old Guest Management Interface

To add guest users through the Guest Management interface:

1. Log in to the WebUI with the guest management interface administrator credentials. The guest management interface is displayed.
2. To add a user, click **New**. The **New Guest User** popup window is displayed.
3. Specify a **Username** and **Password**.
4. Retype the password to confirm.
5. Click **OK**.

Adding Guest Users through the New Guest Management Interface

To add guest users through the Guest Management interface:

1. Log in to the WebUI with the guest management interface administrator credentials. The guest management interface is displayed.
2. To add a user, click **+**. The **User** window is displayed.
3. Specify a **Username** and **Password**.
4. Retype the password to confirm.
5. Click **OK**.

Supported Authentication Methods

Authentication is a process of identifying a user through a valid username and password or based on the user's MAC addresses. The following authentication methods are supported in AOS-W Instant:

- [802.1X Authentication](#)
- [MAC Authentication](#)
- [MAC Authentication with 802.1X Authentication](#)
- [Captive Portal Authentication](#)
- [MAC Authentication with Captive Portal Authentication](#)
- [802.1X Authentication with Captive Portal Role](#)
- [WISPr Authentication](#)

802.1X Authentication

802.1X is an IEEE standard that provides an authentication framework for WLANs. The 802.1X standard uses the EAP to exchange messages during the authentication process. The authentication protocols that operate inside the 802.1X framework include EAP-TLS, PEAP, and EAP-TTLS. These protocols allow the network to authenticate the client while also allowing the client to authenticate the network. For more information on EAP authentication framework supported by the OAW-IAPs, see [Supported EAP Authentication Frameworks on page 192](#).

The 802.1X authentication method allows an OAW-IAP to authenticate the identity of a user before providing network access to the user. The RADIUS protocol provides centralized authentication, authorization, and accounting management. For authentication purpose, the wireless client can associate to a NAS or RADIUS

client such as a wireless OAW-IAP. The wireless client can pass data traffic only after a successful 802.1X authentication. Alcatel-Lucent AOS-W Instant supports the IMSI authentication process for device encryption. The EAP-AKA protocol is used with 802.1X to authenticate client access to a client network. The EAP-AKA makes use of IMSI as a permanent identity in the authentication exchange. It is a unique encryption method that is used to track device movement and protect user privacy.

For more information on configuring an OAW-IAP to use 802.1X authentication, see [Configuring 802.1X Authentication for a Network Profile on page 216](#).

MAC Authentication

MAC authentication is used for authenticating devices based on their physical MAC addresses. MAC authentication requires that the MAC address of a machine matches a manually defined list of addresses. This authentication method is not recommended for scalable networks and the networks that require stringent security settings. For more information on configuring an OAW-IAP to use MAC authentication, see [Configuring MAC Authentication for a Network Profile on page 225](#).

MAC Authentication with 802.1X Authentication

This authentication method has the following features:

- MAC authentication precedes 802.1X authentication—The administrators can enable MAC authentication for 802.1X authentication. MAC authentication shares all the authentication server configurations with 802.1X authentication. If a wireless or wired client connects to the network, MAC authentication is performed first. If MAC authentication fails, 802.1X authentication does not trigger. If MAC authentication is successful, 802.1X authentication is attempted. If 802.1X authentication is successful, the client is assigned an 802.1X authentication role. If 802.1X authentication fails, the client is assigned a **deny-all** role or **mac-auth-only** role.
- MAC authentication only role—Allows you to create a **mac-auth-only** role to allow role-based access rules when MAC authentication is enabled for 802.1X authentication. The **mac-auth-only** role is assigned to a client when the MAC authentication is successful and 802.1X authentication fails. If 802.1X authentication is successful, the **mac-auth-only** role is overwritten by the final role. The **mac-auth-only** role is primarily used for wired clients.
- L2 authentication fall-through—Allows you to enable the **l2-authentication-fallthrough** mode. When this option is enabled, the 802.1X authentication is allowed even if the MAC authentication fails. If this option is disabled, 802.1X authentication is not allowed. The **l2-authentication-fallthrough** mode is disabled by default.

For more information on configuring an OAW-IAP to use MAC as well as 802.1X authentication, see [Configuring MAC Authentication with 802.1X Authentication on page 228](#).

Captive Portal Authentication

Captive portal authentication is used for authenticating guest users. For more information on captive portal authentication, see [Captive Portal for Guest Access on page 148](#).

MAC Authentication with Captive Portal Authentication

You can enforce MAC authentication for captive portal clients. For more information on configuring an OAW-IAP to use MAC authentication with captive portal authentication, see [Configuring MAC Authentication with Captive Portal Authentication on page 230](#).

802.1X Authentication with Captive Portal Role

This authentication mechanism allows you to configure different captive portal settings for clients on the same SSID. For example, you can configure an 802.1X SSID and create a role for captive portal access, so that some

of the clients using the SSID derive the captive portal role. You can configure rules to indicate access to external or internal captive portal, or none. For more information on configuring captive portal roles for an SSID with 802.1X authentication, see [Configuring Captive Portal Roles for an SSID on page 179](#).

WISPr Authentication

WISPr authentication allows the smart clients to authenticate on the network when they roam between WISP even if the wireless hotspot uses an ISP with whom the client may not have an account.

If a hotspot is configured to use WISPr authentication in a specific ISP and a client attempts to access the Internet at that hotspot, the WISPr AAA server configured for the ISP authenticates the client directly and allows the client to access the network. If the client only has an account with a *partner* ISP, the WISPr AAA server forwards the client's credentials to the partner ISP's WISPr AAA server for authentication. When the client is authenticated on the partner ISP, it is also authenticated on the hotspot's own ISP as per their service agreements. The OAW-IAP assigns the default WISPr user role to the client when the client's ISP sends an authentication message to the OAW-IAP. For more information on WISPr authentication, see [Configuring WISPr Authentication on page 231](#).

Supported EAP Authentication Frameworks

The following EAP authentication frameworks are supported in the AOS-W Instant network:

- EAP-TLS—The EAP-TLS method supports the termination of EAP-TLS security using the internal RADIUS server. The EAP-TLS requires both server and CA certificates installed on the OAW-IAP. The client certificate is verified on the virtual switch (the client certificate must be signed by a known CA) before the username is verified on the authentication server.
- EAP-TTLS —The EAP-TTLS method uses server-side certificates to set up authentication between clients and servers. However, the actual authentication is performed using passwords.
- EAP-PEAP—EAP-PEAP is an 802.1X authentication method that uses server-side public key certificates to authenticate clients with server. The PEAP authentication creates an encrypted SSL/TLS tunnel between the client and the authentication server. Exchange of information is encrypted and stored in the tunnel ensuring the user credentials are kept secure.
- LEAP—LEAP uses dynamic WEP keys for authentication between the client and authentication server.

To use the OAW-IAP's internal database for user authentication, add the usernames and passwords of the users to be authenticated.



Alcatel-Lucent does not recommend the use of LEAP authentication, because it does not provide any resistance to network attacks.

Authentication Termination on OAW-IAP

OAW-IAPs support EAP termination for enterprise WLAN SSIDs. The EAP termination can reduce the number of exchange packets between the OAW-IAP and the authentication servers. AOS-W Instant allows EAP termination for PEAP-GTC and PEAP-MS-CHAV2. PEAP-GTC termination allows authorization against a LDAP server and external RADIUS server while PEAP-MS-CHAV2 allows authorization against an external RADIUS server.

This allows the users to run PEAP-GTC termination with their username and password to a local Microsoft Active Directory server with LDAP authentication.

- EAP-GTC—This EAP method permits the transfer of unencrypted usernames and passwords from the client to the server. The main uses for EAP-GTC are procuring one-time token cards such as SecureID and using LDAP or RADIUS as the user authentication server. You can also enable caching of user credentials on the OAW-IAP to an external authentication server for user data backup.

- EAP-MSCHAPv2—This EAP method is widely supported by Microsoft clients. A RADIUS server must be used as the back-end authentication server.

Configuring Authentication Servers

This section describes the following procedures:

- [Configuring an External Server for Authentication on page 198](#)
- [Enabling RADIUS Communication over TLS \(RadSec\) on page 207](#)
- [Configuring Dynamic RADIUS Proxy Parameters on page 209](#)

Supported Authentication Servers

Based on the security requirements, you can configure internal or external authentication servers. This section describes the types of servers that can be configured for client authentication:

- [Internal RADIUS Server on page 193](#)
- [External RADIUS Server on page 193](#)
- [Dynamic Load Balancing between Two Authentication Servers on page 198](#)

Starting from AOS-W Instant 6.4.0.2-4.1 release, you can configure TACACS+ server for authenticating management users. For more information on management users and TACACS+ server-based authentication, see [Configuring Authentication Parameters for Management Users](#).

Internal RADIUS Server

Each OAW-IAP has an instance of free RADIUS server operating locally. When you enable the internal RADIUS server option for the network, the client on the OAW-IAP sends a RADIUS packet to the local IP address. The internal RADIUS server listens and replies to the RADIUS packet. Instant serves as a RADIUS server for 802.1X authentication. However, the internal RADIUS server can also be configured as a backup RADIUS server for an external RADIUS server.

External RADIUS Server

In the external RADIUS server, the IP address of the virtual switch is configured as the NAS IP address. AOS-W Instant RADIUS is implemented on the virtual switch and this eliminates the need to configure multiple NAS clients for every OAW-IAP on the RADIUS server for client authentication. AOS-W Instant RADIUS dynamically forwards all the authentication requests from a NAS to a remote RADIUS server. The RADIUS server responds to the authentication request with an **Access-Accept** or **Access-Reject** message, and the clients are allowed or denied access to the network depending on the response from the RADIUS server. When you enable an external RADIUS server for the network, the client on the OAW-IAP sends a RADIUS packet to the local IP address. The external RADIUS server then responds to the RADIUS packet.

AOS-W Instant supports the following external authentication servers:

- RADIUS
- LDAP
- ClearPass Policy Manager Server for AirGroup CoA

To use an LDAP server for user authentication, configure the LDAP server on the virtual switch, and configure user IDs and passwords. To use a RADIUS server for user authentication, configure the RADIUS server on the virtual switch.

RADIUS Server Authentication with VSA

An external RADIUS server authenticates network users and returns to the OAW-IAP the VSA that contains the name of the network role for the user. The authenticated user is placed into the management role specified by the VSA.

AOS-W Instant supports the following VSAs for user role and VLAN derivation rules:

- AP-Group
- AP-Name
- ARAP-Features
- ARAP-Security
- ARAP-Security-Data
- ARAP-Zone-Access
- Acct-Authentic
- Acct-Delay-Time
- Acct-Input-Gigawords
- Acct-Input-Octets
- Acct-Input-Packets
- Acct-Interim-Interval
- Acct-Link-Count
- Acct-Multi-Session-Id
- Acct-Output-Gigawords
- Acct-Output-Octets
- Acct-Output-Packets
- Acct-Session-Id
- Acct-Session-Time
- Acct-Status-Type
- Acct-Terminate-Cause
- Acct-Tunnel-Packets-Lost
- Add-Port-To-IP-Address
- Aruba-AP-Group
- Aruba-AP-IP-Address
- Aruba-AS-Credential-Hash
- Aruba-AS-User-Name
- Aruba-Admin-Path
- Aruba-Admin-Role
- Aruba-AirGroup-Device-Type
- Aruba-AirGroup-Shared-Group
- Aruba-AirGroup-Shared-Role
- Aruba-AirGroup-Shared-User
- Aruba-AirGroup-User-Name
- Aruba-AirGroup-Version
- Aruba-Auth-SurvMethod
- Aruba-Auth-Survivability

- Aruba-CPPM-Role
- Aruba-Calea-Server-Ip
- Aruba-Device-Type
- Aruba-Essid-Name
- Aruba-Framed-IPv6-Address
- Aruba-Location-Id
- Aruba-Mdps-Device-Iccid
- Aruba-Mdps-Device-Imei
- Aruba-Mdps-Device-Name
- Aruba-Mdps-Device-Product
- Aruba-Mdps-Device-Profile
- Aruba-Mdps-Device-Serial
- Aruba-Mdps-Device-Udid
- Aruba-Mdps-Device-Version
- Aruba-Mdps-Max-Devices
- Aruba-Mdps-Provisioning-Settings
- Aruba-Named-User-Vlan
- Aruba-Network-SSO-Token
- Aruba-No-DHCP-Fingerprint
- Aruba-Port-Bounce-Host
- Aruba-Port-Id
- Aruba-Priv-Admin-User
- Aruba-Template-User
- Aruba-User-Group
- Aruba-User-Role
- Aruba-User-Vlan
- Aruba-WorkSpace-App-Name
- Authentication-Sub-Type
- Authentication-Type
- CHAP-Challenge
- Callback-Id
- Callback-Number
- Chargeable-User-Identity
- Cisco AV-Pair
- Class
- Connect-Info
- Connect-Rate
- Crypt-Password
- DB-Entry-State
- Digest-Response
- Domain-Name
- EAP-Message

- Error-Cause
- Event-Timestamp
- Exec-Program
- Exec-Program-Wait
- Expiration
- Fall-Through
- Filter-Id
- Framed-AppleTalk-Link
- Framed-AppleTalk-Network
- Framed-AppleTalk-Zone
- Framed-Compression
- Framed-IP-Address
- Framed-IP-Netmask
- Framed-IPX-Network
- Framed-IPv6-Pool
- Framed-IPv6-Prefix
- Framed-IPv6-Route
- Framed-Interface-Id
- Framed-MTU
- Framed-Protocol
- Framed-Route
- Framed-Routing
- Full-Name
- Group
- Group-Name
- Hint
- Huntgroup-Name
- Idle-Timeout
- Location-Capable
- Location-Data
- Location-Information
- Login-IP-Host
- Login-IPv6-Host
- Login-LAT-Node
- Login-LAT-Port
- Login-LAT-Service
- Login-Service
- Login-TCP-Port
- Menu
- Message-Auth
- NAS-IPv6-Address
- NAS-Port-Type

- Operator-Name
- Password
- Password-Retry
- Port-Limit
- Prefix
- Prompt
- Rad-Authenticator
- Rad-Code
- Rad-Id
- Rad-Length
- Reply-Message
- Requested-Location-Info
- Revoke-Text
- Server-Group
- Server-Name
- Service-Type
- Session-Timeout
- Simultaneous-Use
- State
- Strip-User-Name
- Suffix
- Termination-Action
- Termination-Menu
- Tunnel-Assignment-Id
- Tunnel-Client-Auth-Id
- Tunnel-Client-Endpoint
- Tunnel-Connection-Id
- Tunnel-Medium-Type
- Tunnel-Preference
- Tunnel-Private-Group-Id
- Tunnel-Server-Auth-Id
- Tunnel-Server-Endpoint
- Tunnel-Type
- User-Category
- User-Name
- User-Vlan
- Vendor-Specific
- fw_mode
- dhcp-option
- dot1x-authentication-type
- mac-address
- mac-address-and-dhcp-options

TACACS Servers

You can now configure a TACACS server as the authentication server to authenticate and authorize all types of management users, and account user sessions. When configured, the TACACS server allows a remote access server to communicate with an authentication server to determine if the user has access to the network. The OAW-IAP users can create several TACACS server profiles and associate these profiles to the user accounts to enable authentication of the management users.

TACACS supports the following types of authentication:

- ASCII
- PAP
- CHAP
- ARAP
- MS-CHAP



The TACACS server cannot be attributed to any SSID or wired profile in general as the authentication server and is configured only for the OAW-IAP management users.

Dynamic Load Balancing between Two Authentication Servers

You can configure two authentication servers to serve as a primary and backup RADIUS server and enable load balancing between these servers. Load balancing of authentication servers ensures that the authentication load is split across multiple authentication servers and enables the OAW-IAPs to perform load balancing of authentication requests destined to authentication servers such as RADIUS or LDAP.

The load balancing in OAW-IAP is performed based on outstanding authentication sessions. If there are no outstanding sessions and if the rate of authentication is low, only primary server will be used. The secondary is used only if there are outstanding authentication sessions on the primary server. With this, the load balance can be performed across RADIUS servers of asymmetric capacity without the need to obtain inputs about the server capabilities from the administrators.

Configuring an External Server for Authentication

You can configure RADIUS, TACACS, LDAP, and ClearPass Policy Manager servers using the WebUI or the CLI.

In the Old WebUI

To configure an external authentication server:

1. Navigate to **Security > Authentication Servers**. The **Security** window is displayed.
 2. To create a new server, click **New**. A window for specifying details for the new server is displayed.
 3. Configure parameters based on the type of sever.
- **RADIUS**—To configure a RADIUS server, specify the attributes described in the following table:

Table 46: RADIUS Server Configuration Parameters

Parameter	Description
Name	Enter a name for the server.
IP address	Enter the host name or the IP address of the external RADIUS server. NOTE: The hose name value will be accepted only if the RadSec parameter is enabled.
RadSec	Set RadSec to Enabled to enable secure communication between the RADIUS server and OAW-IAP by creating a TLS tunnel between the OAW-IAP and the server.

Table 46: RADIUS Server Configuration Parameters

Parameter	Description
	<p>If RadSec is enabled, the following configuration options are displayed:</p> <ul style="list-style-type: none"> ■ RadSec port—Communication port number for RadSec TLS connection. By default, the port number is set to 2083. ■ RFC 3576 ■ RFC 5997 ■ NAS IP address ■ NAS identifier ■ Service type framed user <p>For more information on RadSec configuration, see Enabling RADIUS Communication over TLS (RadSec) on page 207.</p>
Auth port	Enter the authorization port number of the external RADIUS server within the range of 1–65,535. The default port number is 1812.
Accounting port	Enter the accounting port number within the range of 1–65,535. This port is used for sending accounting records to the RADIUS server. The default port number is 1813.
Shared key	Enter a shared key for communicating with the external RADIUS server.
Retype key	Re-enter the shared key.
Timeout	Specify a timeout value in seconds. The value determines the timeout for one RADIUS request. The OAW-IAP retries to send the request several times (as configured in the Retry count) before the user gets disconnected. For example, if the Timeout is 5 seconds, Retry counter is 3, user is disconnected after 20 seconds. The default value is 5 seconds.
Retry count	Specify a number between 1 and 5. Indicates the maximum number of authentication requests that are sent to the server group, and the default value is 3 requests.
RFC 3576	Select Enabled to allow the OAW-IAPs to process RFC 3576-compliant CoA and disconnect messages from the RADIUS server. Disconnect messages cause a user session to be terminated immediately, whereas the CoA messages modify session authorization attributes such as data filters.
RFC 5997	<p>This helps to detect the server status of the RADIUS server. Every time there is an authentication or accounting request timeout, the OAW-IAP will send a status request enquiry to get the actual status of the RADIUS server before confirming the status of the server to be DOWN.</p> <ul style="list-style-type: none"> ■ Authentication—Select this check-box to ensure the OAW-IAP sends a status-server request to determine the actual state of the authentication server before marking the server as unavailable. ■ Accounting—Select this check-box to ensure the OAW-IAP sends a status-server request to determine the actual state of the accounting server before marking the server as unavailable. <p>NOTE: You can choose to select either the Authentication or Accounting check-boxes or select both check-boxes to support RFC5997.</p>
NAS IP address	<p>Allows you to configure an arbitrary IP address to be used as RADIUS attribute 4, NAS IP Address, without changing source IP Address in the IP header of the RADIUS packet.</p> <p>NOTE: If you do not enter the IP address, the virtual switch IP address is used by default when Dynamic RADIUS Proxy is enabled.</p>
NAS Identifier	Allows you to configure strings for RADIUS attribute 32, NAS Identifier, to be sent with RADIUS requests to the RADIUS server.
Dead Time	Specify a dead time for authentication server in minutes.

Table 46: RADIUS Server Configuration Parameters

Parameter	Description
	When two or more authentication servers are configured on the OAW-IAP and a server is unavailable, the dead time configuration determines the duration for which the authentication server would be available if the server is marked as unavailable.
Dynamic RADIUS proxy parameters	Specify the following dynamic RADIUS proxy parameters: <ul style="list-style-type: none"> ■ DRP IP—IP address to be used as source IP for RADIUS packets. ■ DRP Mask—Subnet mask of the DRP IP address. ■ DRP VLAN—VLAN in which the RADIUS packets are sent. ■ DRP Gateway—Gateway IP address of the DRP VLAN. For more information on dynamic RADIUS proxy parameters and configuration procedure, see Configuring Dynamic RADIUS Proxy Parameters on page 209 .
Service type framed user	Sets the service type value to frame for the following authentication methods: <ul style="list-style-type: none"> ■ 802.1X—Changes the service type to frame for 802.1X authentication. ■ Captive Portal—Changes the service type to frame for Captive Portal authentication. ■ MAC—Changes the service type to frame for MAC authentication.

To assign the RADIUS authentication server to a network profile, select the newly added server when configuring security settings for a wireless or wired network profile.



You can also add an external RADIUS server by selecting the **New** option when configuring a WLAN or wired profile. For more information, see [Configuring Security Settings for a WLAN SSID Profile on page 111](#) and [Configuring Security Settings for a Wired Profile on page 137](#).

- **LDAP**—To configure an LDAP server, select the **LDAP** option and configure the attributes described in the following table:

Table 47: LDAP Server Configuration Parameters

Parameter	Description
Name	Enter a name for the server.
IP address	Enter the IP address of the LDAP server.
Auth port	Enter the authorization port number of the LDAP server. The default port number is 389. NOTE: Secure LDAP over SSL is currently not supported on OAW-IAPs. Changing the authentication port to 636 will not enable secure LDAP over SSL.
Admin-DN	Enter a DN for the admin user with read/search privileges across all the entries in the LDAP database (the user need not have write privileges, but the user must be able to search the database, and read attributes of other users in the database).
Admin password	Enter a password for administrator.
Base-DN	Enter a DN for the node that contains the entire user database.
Filter	Specify the filter to apply when searching for a user in the LDAP database. The default filter string is (objectclass=*) .
Key Attribute	Specify the attribute to use as a key while searching for the LDAP server. For Active Directory, the value is sAMAccountName

Table 47: LDAP Server Configuration Parameters

Parameter	Description
Timeout	Enter a value between 1 and 30 seconds. The default value is 5.
Retry count	Enter a value between 1 and 5. The default value is 3.
Dead Time	Specify a dead time for the authentication server in minutes within the range of 1–1440 minutes. The default dead time interval is 5 minutes. When two or more authentication servers are configured on the OAW-IAP and a server is unavailable, the dead time configuration determines the duration for which the authentication server would be available if the server is marked as unavailable.

- **TACACS**—To configure TACACS server, select the **TACACS** option and configure the following parameters:

Table 48: TACACS Configuration Parameters

Parameter	Description
Name	Enter a name for the server.
IP address	Enter the IP address of the TACACS server.
Auth Port	Enter a TCPIP port used by the server. The default port number is 49.
Shared Key	Enter a secret key of your choice to authenticate communication between the TACACS+ client and the server.
Retype Key	Re-enter the shared key.
Timeout	Enter a number between 1 and 30 seconds to indicate the timeout period for TACACS+ requests. The default value is 20 seconds.
Retry Count	Enter a number between 1 and 5 to indicate the maximum number of authentication attempts. The default value is 3.
Dead time	Specify a dead time in minutes within the range of 1–1440 minutes. The default dead time interval is 5 minutes.
Session authorization	Enables or disables session authorization. When enabled, the optional authorization session is turned on for the admin users. By default, session authorization is disabled.



You can also add TACACS server by selecting the **New** option when configuring authentication parameters for management users. For more information, see [Configuring Authentication Parameters for Management Users on page 187](#).

- **CoA only** for AirGroup CoA—To configure a ClearPass Policy Manager server used for AirGroup CoA, select the **CoA only** check box. The RADIUS server is automatically selected.

Table 49: ClearPass Policy Manager Server Configuration Parameters for AirGroup CoA

Parameter	Description
Name	Enter a name of the server.
IP address	Enter the host name or IP address of the server.
Air Group CoA port	Enter a port number for sending AirGroup CoA on a port different from the standard CoA port. The default value is 5999.
Shared key	Enter a shared key for communicating with the external RADIUS server.
Retype key	Re-enter the shared key.

4. Click **OK**.



The ClearPass Policy Manager server acts as a RADIUS server and asynchronously provides the AirGroup parameters for the client device including shared user, role, and location.

In the New WebUI

To configure an external authentication server:

1. Navigate to the **Configuration > Security** page.
 2. Expand **Authentication Servers**.
 3. To create a new server, click **+**. The **New Authentication Server** window for specifying details for the new server is displayed.
 4. Configure parameters based on the type of sever.
- **RADIUS**—To configure a RADIUS server, specify the attributes described in the following table:

Table 50: RADIUS Server Configuration Parameters

Parameter	Description
Name	Enter a name for the server.
IP address	Enter the host name or the IP address of the external RADIUS server. NOTE: The hose name value will be accepted only if the RadSec parameter is enabled.
RadSec	Click the toggle switch to enable secure communication between the RADIUS server and OAW-IAP by creating a TLS tunnel between the OAW-IAP and the server. When RadSec is enabled, the following configuration options are displayed: <ul style="list-style-type: none"> ■ RadSec port—Communication port number for RadSec TLS connection. By default, the port number is set to 2083. ■ RFC 3576 ■ RFC 5997 ■ NAS IP address ■ NAS identifier ■ Service type framed user For more information on RadSec configuration, see Enabling RADIUS Communication over TLS (RadSec) on page 207 .
Auth port	Enter the authorization port number of the external RADIUS server within the range of 1–65,535. The default port number is 1812.

Table 50: RADIUS Server Configuration Parameters

Parameter	Description
Accounting port	Enter the accounting port number within the range of 1–65,535. This port is used for sending accounting records to the RADIUS server. The default port number is 1813.
Shared secret	Enter a shared key for communicating with the external RADIUS server.
Retype secret	Re-enter the shared key.
Timeout	Specify a timeout value in seconds. The value determines the timeout for one RADIUS request. The OAW-IAP retries to send the request several times (as configured in the Retry count) before the user gets disconnected. For example, if the Timeout is 5 seconds, Retry counter is 3, user is disconnected after 20 seconds. The default value is 5 seconds.
Retry count	Specify a number between 1 and 5. Indicates the maximum number of authentication requests that are sent to the server group, and the default value is 3 requests.
Dynamic Authorization	Click the toggle switch to allow the OAW-IAPs to process RFC 3576-compliant CoA and disconnect messages from the RADIUS server. Disconnect messages cause a user session to be terminated immediately, whereas the CoA messages modify session authorization attributes such as data filters.
Status Server	This helps to detect the server status of the RADIUS server. Every time there is an authentication or accounting request timeout, the OAW-IAP will send a status request enquiry to get the actual status of the RADIUS server before confirming the status of the server to be DOWN. <ul style="list-style-type: none"> ■ Authentication—Select this check-box to ensure the OAW-IAP sends a status-server request to determine the actual state of the authentication server before marking the server as unavailable. ■ Accounting—Select this check-box to ensure the OAW-IAP sends a status-server request to determine the actual state of the accounting server before marking the server as unavailable. NOTE: You can choose to select either the Authentication or Accounting check-boxes or select both check-boxes to support RFC5997.
NAS IP address	Allows you to configure an arbitrary IP address to be used as RADIUS attribute 4, NAS IP Address, without changing source IP Address in the IP header of the RADIUS packet. NOTE: If you do not enter the IP address, the virtual switch IP address is used by default when Dynamic RADIUS Proxy is enabled.
NAS Identifier	Allows you to configure strings for RADIUS attribute 32, NAS Identifier, to be sent with RADIUS requests to the RADIUS server.
Dead Time	Specify a dead time for authentication server in minutes. When two or more authentication servers are configured on the OAW-IAP and a server is unavailable, the dead time configuration determines the duration for which the authentication server would be available if the server is marked as unavailable.
Dynamic RADIUS proxy parameters	Specify the following dynamic RADIUS proxy parameters: <ul style="list-style-type: none"> ■ DRP IP—IP address to be used as source IP for RADIUS packets. ■ DRP Mask—Subnet mask of the DRP IP address. ■ DRP VLAN—VLAN in which the RADIUS packets are sent. ■ DRP Gateway—Gateway IP address of the DRP VLAN. For more information on dynamic RADIUS proxy parameters and configuration procedure, see Configuring Dynamic RADIUS Proxy Parameters on page 209 .
Service type framed user	Sets the service type value to frame for the following authentication methods: <ul style="list-style-type: none"> ■ 802.1X—Changes the service type to frame for 802.1X authentication. ■ Captive Portal—Changes the service type to frame for Captive Portal authentication. ■ MAC—Changes the service type to frame for MAC authentication.

To assign the RADIUS authentication server to a network profile, select the newly added server when configuring security settings for a wireless or wired network profile.



You can also add an external RADIUS server by selecting the + option when configuring a WLAN or wired profile. For more information, see [Configuring Security Settings for a WLAN SSID Profile on page 111](#) and [Configuring Security Settings for a Wired Profile on page 137](#).

- **LDAP**—To configure an LDAP server, select the **LDAP** radio button and configure the attributes described in the following table:

Table 51: LDAP Server Configuration Parameters

Parameter	Description
Name	Enter a name for the server.
IP address	Enter the IP address of the LDAP server.
Auth port	Enter the authorization port number of the LDAP server. The default port number is 389. NOTE: Secure LDAP over SSL is currently not supported on OAW-IAPs. Changing the authentication port to 636 will not enable secure LDAP over SSL.
Admin-DN	Enter a DN for the admin user with read/search privileges across all the entries in the LDAP database (the user need not have write privileges, but the user must be able to search the database, and read attributes of other users in the database).
Admin password	Enter a password for administrator. To confirm, re-enter the password in the Retype password text box.
Base-DN	Enter a DN for the node that contains the entire user database.
Filter	Specify the filter to apply when searching for a user in the LDAP database. The default filter string is (objectclass=*) .
Key Attribute	Specify the attribute to use as a key while searching for the LDAP server. For Active Directory, the value is sAMAccountName
Timeout	Enter a value between 1 and 30 seconds. The default value is 5.
Retry count	Enter a value between 1 and 5. The default value is 3.
Dead Time	Specify a dead time for the authentication server in minutes within the range of 1–1440 minutes. The default dead time interval is 5 minutes. When two or more authentication servers are configured on the OAW-IAP and a server is unavailable, the dead time configuration determines the duration for which the authentication server would be available if the server is marked as unavailable.

- **TACACS**—To configure TACACS server, select the **TACACS** radio button and configure the following parameters:

Table 52: TACACS Configuration Parameters

Parameter	Description
Name	Enter a name for the server.
IP address	Enter the IP address of the TACACS server.
Auth port	Enter a TCPIP port used by the server. The default port number is 49.
Shared Secret	Enter a secret key of your choice to authenticate communication between the TACACS+ client and the server.
Retype Secret	Re-enter the shared key.
Time out	Enter a number between 1 and 30 seconds to indicate the timeout period for TACACS+ requests. The default value is 20 seconds.
Retry count	Enter a number between 1 and 5 to indicate the maximum number of authentication attempts. The default value is 3.
Dead time	Specify a dead time in minutes within the range of 1–1440 minutes. The default dead time interval is 5 minutes.
Session authorization	Enables or disables session authorization. When enabled, the optional authorization session is turned on for the admin users. By default, session authorization is disabled.



You can also add TACACS server by selecting the + option when configuring authentication parameters for management users. For more information, see [Configuring Authentication Parameters for Management Users on page 187](#).

- **CoA only** for AirGroup CoA—To configure a ClearPass Policy Manager server used for AirGroup CoA, select the **CoA only** check box. The RADIUS server is automatically selected.

Table 53: ClearPass Policy Manager Server Configuration Parameters for AirGroup CoA

Parameter	Description
Name	Enter a name of the server.
IP Address	Enter the host name or IP address of the server.
Air Group CoA port	Enter a port number for sending AirGroup CoA on a port different from the standard CoA port. The default value is 5999.
Shared key	Enter a shared key for communicating with the external RADIUS server.
Retype key	Re-enter the shared key.

5. Click **OK**.



The ClearPass Policy Manager server acts as a RADIUS server and asynchronously provides the AirGroup parameters for the client device including shared user, role, and location.

In the CLI

To configure a RADIUS server with DRP parameters:

```
(Instant AP) (config)# wlan auth-server <profile-name>
```

```

(Instant AP) (Auth Server <profile-name>)# ip <host>
(Instant AP) (Auth Server <profile-name>)# key <key>
(Instant AP) (Auth Server <profile-name>)# port <port>
(Instant AP) (Auth Server <profile-name>)# acctport <port>
(Instant AP) (Auth Server <profile-name>)# nas-id <NAS-ID>
(Instant AP) (Auth Server <profile-name>)# nas-ip <NAS-IP-address>
(Instant AP) (Auth Server <profile-name>)# timeout <seconds>
(Instant AP) (Auth Server <profile-name>)# retry-count <number>
(Instant AP) (Auth Server <profile-name>)# rfc3576
(Instant AP) (Auth Server <profile-name>)# rfc5997 {auth-only|acct-only}
(Instant AP) (Auth Server <profile-name>)# deadtime <minutes>
(Instant AP) (Auth Server <profile-name>)# drp-ip <IP-address> <mask> vlan <vlan> gateway
<gateway-IP-address>

```

To enable RadSec:

```

(Instant AP) (config)# wlan auth-server <profile-name>
(Instant AP) (Auth Server "name")# ip <host>
(Instant AP) (Auth Server "name")# radsec [port <port>]
(Instant AP) (Auth Server "name")# rfc3576
(Instant AP) (Auth Server "name")# rfc5997 {auth-only|acct-only}
(Instant AP) (Auth Server "name")# nas-id <id>
(Instant AP) (Auth Server "name")# nas-ip <ip>

```

To configure an LDAP server:

```

(Instant AP) (config)# wlan ldap-server <profile-name>
(Instant AP) (LDAP Server <profile-name>)# ip <IP-address>
(Instant AP) (LDAP Server <profile-name>)# port <port>
(Instant AP) (LDAP Server <profile-name>)# admin-dn <name>
(Instant AP) (LDAP Server <profile-name>)# admin-password <password>
(Instant AP) (LDAP Server <profile-name>)# base-dn <name>
(Instant AP) (LDAP Server <profile-name>)# filter <filter>
(Instant AP) (LDAP Server <profile-name>)# key-attribute <key>
(Instant AP) (LDAP Server <profile-name>)# timeout <seconds>
(Instant AP) (LDAP Server <profile-name>)# retry-count <number>
(Instant AP) (LDAP Server <profile-name>)# deadtime <minutes>

```

To configure a TACACS+ server:

```

(Instant AP) (config)# wlan tacacs-server <profile-name>
(Instant AP) (TACACS Server <profile-name>)# ip <IP-address>
(Instant AP) (TACACS Server <profile-name>)# port <port>
(Instant AP) (TACACS Server <profile-name>)# key <key>
(Instant AP) (TACACS Server <profile-name>)# timeout <seconds>
(Instant AP) (TACACS Server <profile-name>)# retry-count <number>
(Instant AP) (TACACS Server <profile-name>)# deadtime <minutes>

```

To configure a ClearPass Policy Manager server used for AirGroup CoA:

```

(Instant AP) (config)# wlan auth-server <profile-name>
(Instant AP) (Auth Server <profile-name>)# ip <host>
(Instant AP) (Auth Server <profile-name>)# key <key>
(Instant AP) (Auth Server <profile-name>)# cppm-rfc3576-port <port>
(Instant AP) (Auth Server <profile-name>)# cppm-rfc3576-only

```

Customizing the RADIUS Attributes

Starting from Alcatel-Lucent AOS-W Instant 8.3.0.0, the users can now configure RADIUS modifier profile to customize the attributes that are included, excluded and modified in the RADIUS request before it is sent to the authentication server. The RADIUS modifier profile can be configured and applied to either Access-Request or Accounting-Request or both on a RADIUS authentication server.

This profile can contain up to 64 RADIUS attributes with static values that are used either to add or update in the request and another 64 RADIUS attributes to be excluded from the Requests.

Two new parameters have been added in the RADIUS authentication-server profile :

- **l auth-modifier:** When assigned, it references to a RADIUS modifier profile which is applied to all Access-Requests sending to this RADIUS authentication-server.
- **l acct-modifier:** When assigned, it references to a RADIUS modifier profile which is applied to all Accounting-Requests sending to this RADIUS authentication-server.

Enabling RADIUS Communication over TLS (RadSec)

You can configure an OAW-IAP to use TLS tunnel and to enable secure communication between the RADIUS server and OAW-IAP. Enabling RADIUS communication over TLS increases the level of security for authentication that is carried out across the cloud network. When configured, this feature ensures that the RadSec protocol is used for safely transmitting the authentication and accounting data between the OAW-IAP and the RadSec server.

The following conditions apply to RadSec configuration:

- When the TLS tunnel is established, RADIUS packets will go through the tunnel.
- By default, the TCP port 2083 is assigned for RadSec. Separate ports are not used for authentication, accounting, and dynamic authorization changes.
- AOS-W Instant supports dynamic CoA (RFC 3576) over RadSec and the RADIUS server uses an existing TLS connection opened by the OAW-IAP to send the request.
- By default, the OAW-IAP uses its device certificate to establish a TLS connection with RadSec server. You can also upload your custom certificates on to OAW-IAP. For more information on uploading certificates, see [Uploading Certificates on page 235](#).

Configuring RadSec Server

You can configure RadSec using the WebUI or the CLI.

In the Old WebUI

1. Navigate to **Security > Authentication Servers**.
2. To create a new server, click **New**. The **New Authentication Server** window for specifying details for the new server is displayed.
3. Select the **RADIUS** server type and configure the following parameters:
 - a. Enter the name of the server.
 - b. Enter the host name or the IP address of the server.
 - c. Select **Enabled** to enable RadSec.
 - d. Ensure that the port defined for RadSec is correct. By default, the port number is set to 2083.
 - e. To allow the OAW-IAPs to process RFC 3576-compliant CoA and disconnect messages from the RADIUS server, set **RFC 3576** to **Enabled**. Disconnect messages cause a user session to be terminated immediately, whereas the CoA messages modify session authorization attributes such as data filters.
 - f. If **RFC 3576** is enabled, specify an AirGroup CoA port if required.
 - g. Enter the NAS IP address.
 - h. Specify the NAS identifier to configure strings for RADIUS attribute 32 and to send it with RADIUS requests to the RADIUS server.
4. Click **OK**.

In the New WebUI

1. Navigate to the **Configuration > Security** page.
2. Expand **Authentication Servers**.

3. To create a new server, click **+**. The **New Authentication Server** window for specifying details for the new server is displayed.
4. Select the **RADIUS** server type and configure the following parameters:
 - a. Enter the name of the server.
 - b. Enter the host name or the IP address of the server.
 - c. Toggle the **RadSec** switch to enable RadSec.
 - d. Ensure that the port defined for RadSec is correct in the **RadSec port** text box. By default, the port number is set to 2083.
 - e. To allow the OAW-IAPs to process RFC 3576-compliant CoA and disconnect messages from the RADIUS server, select the **Dynamic Authorization** toggle switch. Disconnect messages cause a user session to be terminated immediately, whereas the CoA messages modify session authorization attributes such as data filters.
 - f. If **Dynamic Authorization** is enabled, specify an AirGroup CoA port, if required.
 - g. Enter the NAS IP address.
 - h. Specify the NAS identifier to configure strings for RADIUS attribute 32 and to send it with RADIUS requests to the RADIUS server.
5. Click **OK**.

In the CLI

```
(Instant AP) (config)# wlan auth-server <profile-name>
(Instant AP) # ip <host>
(Instant AP) (Auth Server "name")# radsec [port <port>]
(Instant AP) (Auth Server "name")# rfc3576
(Instant AP) (Auth Server "name")# nas-id <id>
(Instant AP) (Auth Server "name")# nas-ip <ip>
```

Associate the RadSec Server Profile with a Network Profile

You can associate the server profile with a network profile using the WebUI or the CLI.

In the Old WebUI

1. Access the WLAN wizard or the Wired Settings window.
 - To open the WLAN wizard, select an existing SSID on the **Networks** tab, and click **edit**.
 - To open the wired settings window, click **More > Wired**. In the **Wired** window, select a profile and click **Edit**.

You can also associate the authentication servers when creating a new WLAN or wired profile.

2. Click the **Security** tab.
3. If you are configuring the authentication server for a WLAN SSID profile, move the slider to **Enterprise** security level and select an authentication type from the **Key management** drop-down list.
4. For a wired profile, set **MAC authentication** or **802.1X authentication** to **Enabled**.
5. From the **Auth server 1** drop-down list, select the server name on which RadSec is enabled. You can also create a new server with Radsec enabled by selecting **New**.
6. Click **Next** and then click **Finish**.
7. To assign the RADIUS authentication server to a network profile, select the newly added server when configuring security settings for a WLAN or wired network profile.

In the New WebUI

1. Access the WLAN wizard or the Wired Settings window (Go to the **Configuration > Networks** page, select a WLAN or a wired profile and click **edit**).

You can also associate the authentication servers when creating a new WLAN or wired profile.

2. Select the **Security** tab.
3. If you are configuring the authentication server for a WLAN SSID profile, move the slider to **Enterprise** security level and select an authentication type from the **Key management** drop-down list.
4. For a wired profile, enable the **MAC authentication** or **802.1X authentication** toggle switch.
5. From the **Auth server 1** drop-down list, select the server on which RadSec is enabled. You can also create a new server with Radsec enabled by clicking **+**.
6. Click **Next** and until **Finish**.
7. To assign the RADIUS authentication server to a network profile, select the newly added server when configuring security settings for a WLAN or wired network profile.

In the CLI

To associate an authentication server to a WLAN SSID:

```
(Instant AP) (config)# wlan ssid-profile <name>
(Instant AP) (SSID Profile <name>)# auth-server <server-name>
```

To associate an authentication server to a wired profile:

```
(Instant AP) (config)# wired-port-profile <name>
(Instant AP) (wired ap profile <name>)# auth-server <name>
```

Configuring Dynamic RADIUS Proxy Parameters

The RADIUS server can be deployed at different locations and VLANs. In most cases, a centralized RADIUS or local server is used to authenticate users. However, some user networks can use a local RADIUS server for employee authentication and a centralized RADIUS-based captive portal server for guest authentication. To ensure that the RADIUS traffic is routed to the required RADIUS server, the dynamic RADIUS proxy feature must be enabled.



The dynamic RADIUS proxy parameters configuration is not required if RadSec is enabled in the RADIUS server profile.

If the OAW-IAP clients need to authenticate to the RADIUS servers through a different IP address and VLAN, ensure that the following steps are completed:

1. [Enable dynamic RADIUS proxy.](#)
2. [Configure dynamic RADIUS proxy IP, VLAN, netmask, and gateway for each authentication server.](#)
3. [Associate the authentication servers to SSID or a wired profile to which the clients connect.](#)

After completing the configuration steps mentioned above, you can authenticate the SSID users against the configured dynamic RADIUS proxy parameters.

Enabling Dynamic RADIUS Proxy

You can enable RADIUS server support using the WebUI or the CLI.

In the Old WebUI

To enable RADIUS server support:

1. In the AOS-W Instant main window, click the **System** link. The **System** window is displayed.

2. In the **General** tab of the **System** window, select the **RADIUS** check box for **Dynamic Proxy**.
3. Click **OK**.

In the New WebUI

To enable RADIUS server support:

1. Navigate to the **Configuration > System** page.
2. Expand **General**.
3. Toggle the **Dynamic RADIUS Proxy** switch to enable.
4. Click **Save**.

When dynamic RADIUS proxy is enabled, the virtual switch network uses the IP Address of the virtual switch for communication with external RADIUS servers. Ensure that the virtual switch IP Address is set as a NAS IP when configuring RADIUS server attributes with dynamic RADIUS proxy enabled. For more information on configuring RADIUS server attributes, see [Configuring an External Server for Authentication on page 198](#).



In case of VPN deployments, the tunnel IP received when establishing a VPN connection is used as the NAS IP. In such cases, the virtual switch IP need not be configured for the external RADIUS servers.

In the CLI

To enable the dynamic RADIUS proxy feature:

```
(Instant AP) (config)# dynamic-radius-proxy
```

Configuring Dynamic RADIUS Proxy Parameters

You can configure DRP parameters for the authentication server by using the WebUI or the CLI.

In the Old WebUI

To configure dynamic RADIUS proxy in the WebUI:

1. Go to **Security > Authentication Servers**.
2. To create a new server, click **New** and configure the required RADIUS server parameters as described in [Table 46](#).
3. Ensure that the following dynamic RADIUS proxy parameters are configured:
 - **DRP IP**—IP address to be used as source IP for RADIUS packets.
 - **DRP Mask**—Subnet mask of the DRP IP address.
 - **DRP VLAN**—VLAN in which the RADIUS packets are sent.
 - **DRP Gateway**—Gateway IP address of the DRP VLAN.
4. Click **OK**.

In the New WebUI

To configure dynamic RADIUS proxy in the WebUI:

1. Navigate to the **Configuration > Security** page.
2. Expand **Authentication Servers**.
3. To create a new server, click **+** and configure the required RADIUS server parameters as described in [Table 46](#).
4. Ensure that the following dynamic RADIUS proxy parameters are configured:
 - **DRP IP**—IP address to be used as source IP for RADIUS packets.
 - **DRP Mask**—Subnet mask of the DRP IP address.
 - **DRP Vlan**—VLAN in which the RADIUS packets are sent.

- **DRP Gateway**—Gateway IP address of the DRP VLAN.

5. Click **OK**.

In the CLI

To configure dynamic RADIUS proxy parameters:

```
(Instant AP) (config)# wlan auth-server <profile-name>
(Instant AP) (Auth Server <profile-name>)# ip <IP-address>
(Instant AP) (Auth Server <profile-name>)# key <key>
(Instant AP) (Auth Server <profile-name>)# port <port>
(Instant AP) (Auth Server <profile-name>)# acctport <port>
(Instant AP) (Auth Server <profile-name>)# nas-id <NAS-ID>
(Instant AP) (Auth Server <profile-name>)# nas-ip <NAS-IP-address>
(Instant AP) (Auth Server <profile-name>)# timeout <seconds>
(Instant AP) (Auth Server <profile-name>)# retry-count <number>
(Instant AP) (Auth Server <profile-name>)# deadtime <minutes>
(Instant AP) (Auth Server <profile-name>)# drp-ip <IP-address> <mask> vlan <vlan> gateway
<gateway-IP-address>
```

Associate DRP Server Profile to a Network Profile

To associate the DRP server profiles with a network profile by using the WebUI or the CLI:

In the Old WebUI

1. Access the WLAN wizard or the Wired Settings window.
 - To open the WLAN wizard, select an existing SSID on the **Networks** tab, and click **edit**.
 - To open the wired settings window, click **More > Wired**. In the **Wired** window, select a profile and click **Edit**.

You can also associate the authentication servers when creating a new WLAN or wired profile.

2. Click the **Security** tab.
3. If you are configuring the authentication server for a WLAN SSID profile, move the slider to **Enterprise** security level and select an authentication type from the **Key management** drop-down list.
4. For a wired profile, set **MAC authentication** or **802.1X authentication** to **Enabled**.
5. From the **Auth server 1** drop-down list, select the server name on which dynamic RADIUS proxy parameters are enabled. You can also create a new server with dynamic RADIUS proxy parameters enabled by selecting **New**.
6. Click **Next** and then click **Finish**.
7. To assign the RADIUS authentication server to a network profile, select the newly added server when configuring security settings for a WLAN or wired network profile.

In the New WebUI

1. Access the WLAN wizard or the Wired Settings window (Go to the **Configuration > Networks**, select a WLAN or a wired profile and click **Edit**).

You can also associate the authentication servers when creating a new WLAN or wired profile.

2. Select the **Security** tab.
3. If you are configuring the authentication server for a WLAN SSID profile, move the slider to **Enterprise** security level and select an authentication type from the **Key management** drop-down list.
4. For a wired profile, enable the **MAC authentication** or **802.1X authentication** toggle switch.

5. From the **Auth server 1** drop-down list, select the server name on which dynamic RADIUS proxy parameters are enabled. You can also create a new server with dynamic RADIUS proxy parameters enabled by selecting **+**.
6. Click **Next** and until **Finish**.
7. To assign the RADIUS authentication server to a network profile, select the newly added server when configuring security settings for a WLAN or wired network profile.



You can also add an external RADIUS server by selecting New for Authentication Server when configuring a WLAN or wired profile. For more information, see [Configuring Security Settings for a WLAN SSID Profile on page 111](#) and [Configuring Security Settings for a Wired Profile on page 137](#).

In the CLI

To associate an authentication server to a WLAN SSID:

```
(Instant AP) (config)# wlan ssid-profile <name>
(Instant AP) (SSID Profile <name>)# auth-server <server-name>
```

To associate an authentication server to a wired profile:

```
(Instant AP) (config)# wired-port-profile <name>
(Instant AP) (wired ap profile <name>)# auth-server <name>
```

Understanding Encryption Types

Encryption is the process of converting data into a cryptic format or code when it is transmitted on a network. Encryption prevents unauthorized use of the data.

AOS-W Instant supports the following types of encryption:

- **WEP**—WEP is an authentication method where all users share the same key. WEP is not as secure as other encryption types such as TKIP.
- **TKIP**—TKIP uses the same encryption algorithm as WEP. However, TKIP is more secure and has an additional message integrity check.
- **AES**—The AES encryption algorithm is a widely supported encryption type for all wireless networks that contain any confidential data. AES in Wi-Fi leverages 802.1X or PSKs to generate per-station keys for all devices. AES provides a high level of security like IPsec clients.



WEP and TKIP are limited to WLAN connection speed of 54 Mbps. The 802.11n connection supports only AES encryption. Alcatel-Lucent recommends AES encryption. Ensure that all devices that do not support AES are upgraded or replaced with the devices that support AES encryption.

WPA and WPA-2

WPA is created based on the draft of 802.11i, which allowed users to create more secure WLANs. WPA-2 encompasses the full implementation of the 802.11i standard. WPA-2 is a superset that encompasses the full WPA feature set.

The following table summarizes the differences between the two certifications:

Table 54: WPA and WPA-2 Features

Certification	Authentication	Encryption
WPA	<ul style="list-style-type: none"> ■ PSK ■ IEEE 802.1X with EAP 	TKIP with message integrity check
WPA-2	<ul style="list-style-type: none"> ■ PSK ■ IEEE 802.1X with EAP 	AES—Counter Mode with Cipher Block Chaining Message Authentication Code

WPA and WPA-2 can be further classified as follows:

- **Personal**—Personal is also called PSK. In this type, a unique key is shared with each client in the network. Users have to use this key to securely log in to the network. The key remains the same until it is changed by authorized personnel. You can also configure key change intervals.
- **Enterprise**—Enterprise is more secure than WPA Personal. In this type, every client automatically receives a unique encryption key after securely logging in to the network. This key is automatically updated at regular intervals. WPA uses TKIP and WPA-2 uses the AES algorithm.

Recommended Authentication and Encryption Combinations

The following table summarizes the recommendations for authentication and encryption combinations for the Wi-Fi networks.

Table 55: Recommended Authentication and Encryption Combinations

Network Type	Authentication	Encryption
Employee	802.1X	AES
Guest Network	Captive portal	None
Voice Network or Handheld devices	802.1X or PSK as supported by the device	AES if possible, TKIP or WEP if necessary (combine with security settings assigned for a user role).

Configuring Authentication Survivability

The authentication survivability feature supports a survivable authentication framework against any remote link failures when working with external authentication servers. When enabled, this feature allows the OAW-IAPs to authenticate the previously connected clients against the cached credentials if the connection to the authentication server is temporarily lost.

AOS-W Instant supports the following EAP standards for authentication survivability:

- **EAP-MSCHAPv2:** The PEAP, also known as Protected EAP, is a protocol that encapsulates EAP within a potentially encrypted and authenticated TLS tunnel.
- **EAP-TLS:** EAP-TLS is an IETF open standard that uses the TLS protocol.

When the authentication survivability feature is enabled, the following authentication process is used:

1. Upon successful authentication, the associated OAW-IAP caches the authentication credentials of the connected clients for the configured duration. The cache expiry duration for authentication survivability can be set within the range of 1–99 hours, with 24 hours being the default cache timeout duration.

2. If the client roams or tries to reconnect to the OAW-IAP and the remote link fails due to the unavailability of the authentication server, the OAW-IAP uses the cached credentials in the internal authentication server to authenticate the user. However, if the client tries to reconnect after the cache expiry, the authentication fails.
3. When the authentication server is available and if the client tries to reconnect, the OAW-IAP detects the availability of server and allows the client to authenticate to the server. Upon successful authentication, the OAW-IAP cache details are refreshed.

Starting from Alcatel-Lucent AOS-W Instant 8.4.0.0, access credentials, user roles, and other key attributes are cached when clients are authenticated by an external authentication server.

Below are the cached RADIUS attributes:

- ARUBA_NAMED_VLAN
- ARUBA_NO_DHCP_FINGERPRINT
- ARUBA_ROLE
- ARUBA_VLAN
- MS_TUNNEL_MEDIUM_TYPE
- MS_TUNNEL_PRIVATE_GROUP_ID
- MS_TUNNEL_TYPE
- PW_SESSION_TIMEOUT
- PW_USER_NAME

Enabling Authentication Survivability

You can enable authentication survivability for a wireless network profile through the WebUI or the CLI.

In the Old WebUI

To configure authentication survivability for a wireless network:

1. On the **Networks** tab, click **New** to create a new WLAN SSID profile or select an existing profile for which you want to enable authentication survivability and click **edit**.
2. In the **Edit <profile-name>** or the **New WLAN** window, ensure that the required WLAN and VLAN attributes are defined, and then click **Next**.
3. On the **Security** tab, under **Enterprise** security settings, select an existing authentication server or create a new server by clicking **New**.
4. To enable authentication survivability, select **Enabled** from the **Authentication survivability** drop-down list. On enabling this, the OAW-IAP authenticates the previously connected clients using EAP-PEAP and EAP-TLS authentication when connection to the external authentication server is temporarily lost.
5. In the **Cache timeout (global)** text box, specify the cache timeout duration, after which the cached details of the previously authenticated clients expire. You can specify a value within the range of 1–99 hours and the default cache timeout duration is 24 hours.
6. Click **Next** and then click **Finish** to apply the changes.

In the New WebUI

To configure authentication survivability for a wireless network:

1. In the **Configuration > Networks** page,
 - Click **+** to create a new WLAN SSID profile, or
 - Select an existing profile for which you want to enable authentication survivability and click **edit**.
2. Ensure that the required WLAN and VLAN attributes are defined under **Basic** and **VLAN** tabs.

3. Under **Security** tab, select **Enterprise** in **Security Level** list box.
4. Select an existing authentication server or create a new server by clicking **+**.
5. To enable authentication survivability, toggle the **Authentication survivability** switch. On enabling this, the OAW-IAP authenticates the previously connected clients using EAP-PEAP and EAP-TLS authentication when connection to the external authentication server is temporarily lost.
6. In the **Cache timeout (global)** text box, specify the cache timeout duration, after which the cached details of the previously authenticated clients expire. You can specify a value within the range of 1–99 hours and the default cache timeout duration is 24 hours.
7. Click **Next** and until **Finish** to apply the changes.

Important Points to Remember

- Any client connected through ClearPass Policy Manager and authenticated through OAW-IAP remains authenticated with the OAW-IAP even if the client is removed from the ClearPass Policy Manager server during the ClearPass Policy Manager downtime.
- Do not make any changes to the authentication survivability cache timeout duration when the authentication server is down.
- For EAP-PEAP authentication, ensure that the ClearPass Policy Manager 6.0.2 or later version is used for authentication. For EAP-TLS authentication, any external or third-party server can be used.
- For EAP-TLS authentication, ensure that the server and CA certificates from the authentication servers are uploaded on the OAW-IAP. For more information, see [Uploading Certificates on page 235](#).
- Authentication cache will be lost if the OAW-IAP on which the user credentials are cached, is rebooted.
- EAP-PEAP authentication survivability is supported on Alcatel-Lucent CPPM Server version 6.0.2 or later versions.

Limitations

Authentication survivability is not supported under the following conditions:

1. When MAC authentication is enabled on the SSID.
2. When EAP Termination is enabled.
3. When the RadSec server is used as an authentication server.
4. When the internal server is used as a secondary authentication server.

In the CLI

To configure authentication survivability for a wireless network:

```
(Instant AP) (config)# wlan ssid-profile <name>
(Instant AP) (SSID Profile <name>)# type {<Employee>|<Voice>|<Guest>}
(Instant AP) (SSID Profile <name>)# auth-server <server-name1>
(Instant AP) (SSID Profile <name>)# auth-survivability
(Instant AP) (SSID Profile <name>)# exit
(Instant AP) (config)# auth-survivability cache-time-out <hours>
```

To view the cache expiry duration:

```
(Instant AP)# show auth-survivability time-out
```

To view the information cached by the OAW-IAP:

```
(Instant AP)# show auth-survivability cached-info
```

To view logs for debugging:

```
(Instant AP)# show auth-survivability debug-log
```

Configuring 802.1X Authentication for a Network Profile

This section consists of the following procedures:

- [Configuring 802.1X Authentication for Wireless Network Profiles on page 216](#)
- [Configuring 802.1X Authentication for Wired Profiles on page 217](#)

The AOS-W Instant network supports internal RADIUS server and external RADIUS server for 802.1X authentication.

The steps involved in 802.1X authentication are as follows:

1. The NAS requests authentication credentials from a wireless client.
2. The wireless client sends authentication credentials to the NAS.
3. The NAS sends these credentials to a RADIUS server.
4. The RADIUS server checks the user identity and authenticates the client if the user details are available in its database. The RADIUS server sends an **Access-Accept** message to the NAS. If the RADIUS server cannot identify the user, it stops the authentication process and sends an **Access-Reject** message to the NAS. The NAS forwards this message to the client and the client must re-authenticate with appropriate credentials.
5. After the client is authenticated, the RADIUS server forwards the encryption key to the NAS. The encryption key is used for encrypting or decrypting traffic sent to and from the client.

In the 802.1X termination-disabled mode, if the identity in the **EAP-ID-Resp** message is longer than or equal to 248 octets and the identity contains **@FQDN** at the end, then the **EAP-ID-Resp** message is not dropped. The RADIUS User-Name attribute contains the truncated-string (up to 127 octets) from the original identify before the last **@FQDN** followed by the last **@FQDN**.



The NAS acts as a gateway to guard access to a protected resource. A client connecting to the wireless network first connects to the NAS.

Configuring 802.1X Authentication for Wireless Network Profiles

You can configure 802.1X authentication for a wireless network profile in the WebUI or the CLI.

In the Old WebUI

To enable 802.1X authentication for a wireless network:

1. On the **Networks** tab, click **New** to create a new WLAN network profile or select an existing profile for which you want to enable 802.1X authentication and click **edit**.
2. In the **Edit <profile-name>** or the **New WLAN** window, ensure that all required WLAN and VLAN attributes are defined, and then click **Next**.
3. On the **Security** tab, specify the following parameters for the **Enterprise** security level:
 - a. Select any of the following options from the **Key management** drop-down list.
 - **WPA-2 Enterprise**
 - **WPA Enterprise**
 - **Both (WPA-2 & WPA)**
 - **Dynamic WEP with 802.1x**. If you do not want to use a session key from the RADIUS server to derive pairwise unicast keys, select the **Session Key for LEAP** check-box.
4. To terminate the EAP portion of 802.1X authentication on the OAW-IAP instead of the RADIUS server, set **EAP Offload** to **Enabled**.

By default, for 802.1X authentication, the client conducts an EAP exchange with the RADIUS server, and the OAW-IAP acts as a relay for this exchange. When **EAP Offload** is enabled, the OAW-IAP by itself acts as an

authentication server and terminates the outer layers of the EAP protocol, only relaying the innermost layer to the external RADIUS server.

5. Specify the type of authentication server to use and configure other required parameters. You can also configure two different authentication servers to function as primary and backup servers when **EAP Offload** is enabled. For more information on RADIUS authentication configuration parameters, see [Configuring an External Server for Authentication on page 198](#).

6. Click **Next** to define access rules, and then click **Finish** to apply the changes.

In the New WebUI

To enable 802.1X authentication for a wireless network:

1. In the **Configuration > Networks** page, click **+** to create a new WLAN network profile or select an existing profile for which you want to enable 802.1X authentication and click **edit**.

2. Ensure that all required WLAN and VLAN attributes are defined, and then click **Next**.

3. Under **Security** tab, specify the following parameters for the **Enterprise** security level:

a. Select any of the following options from the **Key management** drop-down list.

- **WPA-2 Enterprise**

- **WPA Enterprise**

- **Both (WPA-2 & WPA)**

- **Dynamic WEP with 802.1x**. If you do not want to use a session key from the RADIUS server to derive pairwise unicast keys, select the **Use Session Key for LEAP** check-box.

4. To terminate the EAP portion of 802.1X authentication on the OAW-IAP instead of the RADIUS server, toggle the **EAP Offload** switch.

By default, for 802.1X authentication, the client conducts an EAP exchange with the RADIUS server, and the OAW-IAP acts as a relay for this exchange. When **EAP Offload** is enabled, the OAW-IAP by itself acts as an authentication server and terminates the outer layers of the EAP protocol, only relaying the innermost layer to the external RADIUS server.

5. Specify the type of authentication server to use and configure other required parameters. You can also configure two different authentication servers to function as primary and backup servers when **EAP Offload** is enabled. For more information on RADIUS authentication configuration parameters, see [Configuring an External Server for Authentication on page 198](#).

6. Click **Next** to define access rules, and then click **Finish** to apply the changes.

In the CLI

To configure 802.1X authentication for a wireless network:

```
(Instant AP) (config)# wlan ssid-profile <name>
(Instant AP) (SSID Profile <name>)# type {<Employee>|<Voice>}
(Instant AP) (SSID Profile <name>)# opmode {wpa2-aes|wpa-tkip|wpa-tkip,wpa2-aes|dynamic-wep}
(Instant AP) (SSID Profile <name>)# leap-use-session-key
(Instant AP) (SSID Profile <name>)# termination
(Instant AP) (SSID Profile <name>)# auth-server <server1>
(Instant AP) (SSID Profile <name>)# auth-server <server2>
(Instant AP) (SSID Profile <name>)# radius-reauth-interval <minutes>
(Instant AP) (SSID Profile <name>)# auth-survivability
(Instant AP) (SSID Profile <name>)# exit
(Instant AP) (config)# auth-survivability cache-time-out <hours>
```

Configuring 802.1X Authentication for Wired Profiles

You can configure 802.1X authentication for a wired profile in the WebUI or the CLI.

In the Old WebUI

To enable 802.1X authentication for a wired profile:

1. Click the **Wired** link under **More** in the main window. The **Wired** window is displayed.
2. Click **New** under **Wired Networks** to create a new network or select an existing profile for which you want to enable 802.1X authentication and then click **Edit**.
3. In the **New Wired Network** or the **Edit Wired Network** window, ensure that all the required Wired and VLAN attributes are defined, and then click **Next**.
4. On the **Security** tab, select **Enabled** from the **802.1X authentication** drop-down list.
5. Specify the type of authentication server to use and configure other required parameters. For more information on configuration parameters, see [Configuring Security Settings for a Wired Profile on page 137](#).
6. Click **Next** to define access rules, and then click **Finish** to apply the changes.
7. Assign the profile to an Ethernet port. For more information, see [Assigning a Profile to Ethernet Ports on page 142](#).

In the New WebUI

To enable 802.1X authentication for a wired profile:

1. Go to the **Configuration > Networks** page.
2. Click **+** under the **Networks** window to create a new network or select an existing profile for which you want to enable 802.1X authentication and then click **+**.
3. Under the **Basic** tab ensure that the required Wired and VLAN attributes are defined, and then click **Next**.
4. In the **Security** tab, toggle the **802.1X authentication** switch to enable.
5. Specify the type of authentication server to use and configure other required parameters. For more information on configuration parameters, see [Configuring Security Settings for a Wired Profile on page 137](#).
6. Click **Next** to define access rules and then click **Finish** to apply the changes.
7. Assign the profile to an Ethernet port. For more information, see [Assigning a Profile to Ethernet Ports on page 142](#).

In the CLI

To enable 802.1X authentication for a wired profile:

```
(Instant AP) (config)# wired-port-profile <name>
(Instant AP) (wired ap profile <name>)# type {<employee>|<guest>}
(Instant AP) (wired ap profile <name>)# dot1x
(Instant AP) (wired ap profile <name>)# auth-server <server1>
(Instant AP) (wired ap profile <name>)# auth-server <server2>
(Instant AP) (wired ap profile <name>)# server-load-balancing
(Instant AP) (wired ap profile <name>)# radius-reauth-interval <Minutes>
```

Enhanced Open Authentication

Enhanced open authentication provides improved data encryption in open Wi-Fi networks and protects data from sniffing. The enhanced open authentication replaces open system as the default option. With enhanced open authentication, the client and WLAN perform Diffie-Hellman key exchange during the access procedure and use the resulting pairwise key with a 4-way handshake.

Alcatel-Lucent AOS-W Instant supports:

- Enhanced Open without PMK caching
- Enhanced Open with PMK caching

- Enhanced Open transition mode

Enhanced Open Without PMK Caching

In the Enhanced Open opmode without PMK caching, the 802.11 beacon, probe response frame, and authentication request or response frame are generic. However, 802.11 association request or response are specific for enhanced open that does not include PMK caching.

Alcatel-Lucent AOS-W Instant advertises support for enhanced open by using an AKM suite selector in all beacons and probe response frames. Besides, PMF is set to required (MFPR=1). Authentication request and authentication response use open authentication.

A client that wishes to perform data encryption in an open Wi-Fi network using enhanced open, indicates enhanced open AKM in the 802.11 association request with PMF is required (MFPR=1). The DHPE contains group and the Diffie-Hellman public Key from the client. AOS-W Instant supports Diffie-Hellman Group 19, a 256-bit Elliptic Curve group.

AOS-W Instant includes the enhanced open AKM and DHPE in the 802.11 association response after agreeing to enhanced open with PMF is required (MFPR=1). The DHPE contains group and the Diffie-Hellman public key from AOS-W Instant. If AOS-W Instant does not support the group indicated in the received 802.11 association request, it responds with an 802.11 association response having the status code 77. A status code 77 indicates unsupported finite cyclic group.

After completing the 802.11 association, PMK and its associated PMKID are created. AOS-W Instant initiates a 4-way handshake with the client using the generated PMK. The result of the 4-way handshake is the encryption key to protect bulk unicast data and broadcast data between the client and AOS-W Instant.

Enhanced Open With PMK Caching

If enhanced open authentication has been established earlier, a client that wishes to perform enhanced open with PMK caching includes a PMKID in its 802.11 association request in addition to the enhanced open AKM, DHPE, and PMF is required (MFPR=1). If Alcatel-Lucent AOS-W Instant has cached the PMK identified by that PMKID, it includes the PMKID in its 802.11 association response but does not include the DHPE. If AOS-W Instant has not cached the PMK identified by that PMKID, it ignores the PMKID and proceeds with enhanced open association by including a DHPE. The 4-way handshake is initiated subsequently.

Enhanced Open Transition Mode

The enhanced open transition mode enables a seamless transition from open unencrypted WLAN connections without adversely impacting the end user experience. It provides the ability for enhanced open and non-enhanced open clients to connect to the same open system virtual AP.

Two different SSIDs are created for each configured 802.11 open system virtual AP, one for enhanced open authentication and another for open networks. Both SSIDs operate either in the same band and channel or the band and channel of the other SSID (the enhanced open transition mode information element includes the band and channel information). Alcatel-Lucent AOS-W Instant always uses the same band and channel.

802.11 beacon and probe response frames of the open BSS include an enhanced open transition mode information element to encapsulate BSSID and SSID of the enhanced open BSS.

802.11 beacon and probe response frames from the enhanced open BSS include an enhanced open transition mode information element to encapsulate the BSSID and SSID of the open BSS. Besides, the beacon frame from the enhanced open BSS has zero length SSID and indicates enhanced open in robust security network element.

In enhanced open transition mode, Alcatel-Lucent AOS-W Instant uses more virtual APs than configured. The number of virtual APs pushed depends on multizone parameters, if configured (maximum SSIDs per zone).

During enhanced open transition mode, depending on the available VAP slots, AOS-W Instant will either push both open and enhanced open virtual APs or only enhanced-open virtual APs. There will be no impact on other virtual APs configured. An additional enhanced-open virtual AP will be pushed to an AP only if it has an available extra slot.

During transition, if there are many enhanced-open authentication enabled virtual APs, based on the availability of slots, the AP will choose to transition all enhanced-open virtual APs or configure them as enhanced-open-only virtual APs. That is, if there are 2 enhanced-open virtual APs and 4 available slots, the AP will create 2 enhanced-open-only virtual APs and 2 open virtual APs. If the available slots are 3, the AP will create 2 enhanced-open-only virtual APs and no open virtual APs.

Configuring Enhanced Open Authentication

To enable enhanced open authentication using the WebUI:

1. Navigate to the WLAN wizard (To add a new profile, go to **Configuration > Networks** and click **+**. To modify an existing profile, go to **Configuration > Networks**, select a WLAN SSID from the list of networks to edit.
2. Click the **Security** tab.
3. Select **Open** from the **Security Level** drop-down list. The authentication options applicable to the Open network are displayed.
4. The **Enhanced Open** toggle switch is disabled by default. Slide the toggle switch to the right-side to enable the enhanced open function.

To enable enhanced open authentication using the CLI:

```
(Instant AP) (config)# wlan ssid-profile <profile_name>
(Instant AP) (SSID Profile "<profile_name>")# opmode enhanced-open
```

To disable enhanced open authentication using the CLI:

```
(Instant AP) (config)# wlan ssid-profile <profile_name>
(Instant AP) (SSID Profile "<profile_name>")# no opmode
```

To enable opmode transition using the CLI:

```
(Instant AP) (config)# wlan ssid-profile <profile_name>
(Instant AP) (SSID Profile "<profile_name>")# opmode-transition
```

To disable opmode transition using the CLI:

```
(Instant AP) (config)# wlan ssid-profile <profile_name>
(Instant AP) (SSID Profile "<profile_name>")# opmode-transition-disable
```

WPA3

Alcatel-Lucent AOS-W Instant 8.4.0.0 supports WPA3 security improvements that include:

- **Simultaneous Authentication of Equals (SAE)**—Replaces WPA2-PSK with password-based authentication that is resistant to dictionary attacks.
- **WPA3-Enterprise**—Brings Suite-B 192-bit security suite that is aligned with Commercial National Security Algorithm (CNSA) for enterprise network. SAE-based keys are not based on PSK and are therefore pairwise and unique between clients and the AP. Suite B restricts the deployment to one of two options:
 - 128-bit security
 - 192-bit security without the ability to mix-and-match ciphers, Diffie-Hellman groups, hash functions, and signature modes

SAE

SAE replaces the less-secure WPA2-PSK authentication. Instead of using the PSK as the PMK, SAE arrives at a

PMK, by mapping the PSK to an element of a finite cyclic group, PassWord Element (PWE), doing FCG operations on it, and exchanging it with the peer.

Alcatel-Lucent AOS-W Instant supports:

- SAE without PMK caching
- SAE with PMK caching
- SAE or WPA2-PSK mixed mode

SAE Without PMK Caching

AOS-W Instant advertises support for SAE by using an AKM suite selector for SAE in all beacons and probe response frames. Besides, PMF is set to required (MFPR=1).

A client that wishes to perform SAE sends an 802.11 authentication request with authentication algorithm set to value 3 (SAE). This frame contains a well-formed commit message, that is, authentication transaction sequence set to 1, an FCG, commit-scalar, and commit-element.

AOS-W Instant supports group 19, a 256-bit Elliptic Curve group. AOS-W Instant responds with an 802.11 authentication containing its own commit message.

AOS-W Instant and the client compute the PMK and send the confirm message to each other using an authentication frame with authentication transaction sequence set to 2.

The client sends an association request with the AKM suite set to SAE and AOS-W Instant sends an association response.

AOS-W Instant initiates a 4-way key handshake with the client to derive the PTK.

SAE With PMK Caching

If SAE has been established earlier, a client that wishes to perform SAE with PMK caching sends an authentication frame with authentication algorithm set to open. AOS-W Instant sends an authentication response and the client sends a reassociation request with AKM set to SAE and includes the previously derived PMKID.

AOS-W Instant checks if the PMKID is valid and sends an association response with the status code success.

AOS-W Instant initiates a 4-way key handshake with the client to derive the PTK.

SAE or WPA2-PSK Mixed Mode

SAE or WPA2-PSK mixed mode allows both SAE clients and clients that can only perform WPA2-PSK to connect to the same BSSID. In this mode, the beacon or probe responses contain a AKM list which contains both PSK (00-0F-AC:2) and SAE (00-0F-AC:8). Clients that support SAE send an authentication frame with SAE payload and connect to the BSSID.

Clients that support only WPA2-PSK send an authentication frame with authentication algorithm set to open.

AOS-W Instant initiates a 4-way key handshake similar to WPA2.

WPA3-Enterprise

WPA3-Enterprise enforces top secret security standards for an enterprise Wi-Fi in comparison to secret security standards. Top secret security standards includes:

- Deriving at least 384-bit PMK/MSK using Suite B compatible EAP-TLS.
- Securing pairwise data between STA and authenticator using AES-GCM-256.

- Securing group addressed data between STA and authenticator using AES-GCM-256.
- Securing group addressed management frames using BIP-GMAC-256



Alcatel-Lucent AOS-W Instant supports WPA3-Enterprise only in non-termination 802.1X and tunnel-forward modes. WPA3-Enterprise compatible 802.1x authentication occurs between STA and CPPM.

WPA3-Enterprise advertises or negotiates the following capabilities in beacons, probes response, or 802.11 association:

- AKM Suite Selector as 00-0F-AC:12
- Pairwise Cipher Suite Selector as 00-0F-AC:9
- Group data cipher suite selector as 00-0F-AC:9
- Group management cipher suite (MFP) selector as 00-0F-AC:12

If WPA3-Enterprise is enabled, STA is successfully associated only if it uses one of the four suite selectors for AKM selection, pairwise data protection, group data protection, and group management protection. If a STA mismatches any one of the four suite selectors, the STA association fails.

WPA3 Opmodes

Alcatel-Lucent AOS-W Instant supports the WPA3-AES-CCM-128, WPA3-CNSA, and WPA3-SAE-AES opmodes. These opmodes work only in tunnel mode and opmode transition is not applicable to WPA3-AES-CCM-128 and WPA3-CNSA opmodes.

The WPA3 opmodes are effective only on the OAW-300 Series, OAW-303 Series, OAW-AP310 Series, OAW-AP320 Series, OAW-AP330 Series, OAW-340 Series, OAW-360 Series, OAW-370 Series, OAW-AP-387, OAW-AP-514, and OAW-AP-515 access points. Other access points will reject these opmodes.

Before using the WPA3-SAE-AES opmode, disable opmode-transition and configure a WPA hexkey or WPA passphrase as a pre-shared key. Use the WPA3 with SAE and PSK mode for SAE mixed mode operation during transition. The opmode-transition is not applicable to WPA3-AES-CCM-128 and WPA3-CNSA opmodes.

WPA2-PSK-AES virtual APs will not be automatically upgraded to WPA3-SAE-AES virtual APs. Hence, WPA2-PSK-AES virtual APs will not automatically work in mixed mode. Configure a WPA3-SAE-AES virtual AP with opmode-transition for the virtual AP to operate in mixed mode.

Configuring WPA3

To support WPA3, configure the **opmode** and **opmode-transition** parameters under the **wlan ssid-profile** command.

The **opmode-transition** parameter is enabled by default and provides backward compatibility for authentication and WPA3-SAE-AES opmode. Use the **opmode-transition** parameter as a fallback option if a client faces connectivity issues on the enhanced open authentication or WPA3-SAE-AES transition mode virtual APs.

To disable opmode transition using the CLI:

```
(Instant AP) (config)# wlan ssid-profile <profile_name>
(Instant AP) (SSID Profile "<profile_name>")# opmode-transition-disable
```

To enable opmode transition using the CLI:

```
(Instant AP) (config)# wlan ssid-profile <profile_name>
(Instant AP) (SSID Profile "<profile_name>")# opmode-transition
```

To configure WPA3 opmode for Enterprise security using the WebUI:

1. Navigate to the WLAN wizard (To add a new profile, go to **Configuration > Networks** and click **+**. To modify an existing profile, go to **Configuration > Networks** , select a WLAN SSID from the list of networks

to edit.

2. Click the **Security** tab.
3. Select **Enterprise** from the **Security Level** drop-down list. The authentication options applicable to the Enterprise network are displayed.
4. Select **WPA-3 Enterprise** from the **Key Management** drop-down list.
5. Select the **Use CNSA Suite** checkbox. This option is available only for Enterprise security configuration.
6. Click **Next** and then click **Finish**.

To configure WPA3 opmode for Enterprise security using the CLI:

```
(Instant AP) (config)# wlan ssid-profile wpa3_mode
(Instant AP) (SSID Profile "wpa3_mode")# opmode wpa3-aes-ccm-128
(Instant AP) (SSID Profile "wpa3_mode")# opmode wpa3-cnsa
```

To configure WPA3 opmode for Personal security using the WebUI:

1. Navigate to the WLAN wizard (To add a new profile, go to **Configuration > Networks** and click **+**. To modify an existing profile, go to **Configuration > Networks**, select a WLAN SSID from the list of networks to edit.
2. Click the **Security** tab.
3. Select **Personal** from the **Security Level** drop-down list. The authentication options applicable to the Personal network are displayed.
4. Select **WPA-3 Personal** from the **Key Management** drop-down list.
5. Click **Next** and then click **Finish**.

To configure WPA3 opmode for Personal security using the CLI:

```
(Instant AP) (config)# wlan ssid-profile wpa3_mode
(Instant AP) (SSID Profile "wpa3_mode")# opmode wpa3-sae-aes
```



Using the WPA3-SAE-AES opmode requires a pre-shared key. Configure either a WPA hexkey or WPA passphrase as a pre-shared key.

To disable WPA3 opmode using the CLI:

```
(Instant AP) (config)# wlan ssid-profile wpa3_mode
(Instant AP) (SSID Profile "wpa3_mode")# no opmode
```

Enabling 802.1X Supplicant Support

The 802.1X authentication protocol prevents the unauthorized clients from gaining access to the network through publicly accessible ports. If the ports to which the OAW-IAPs are connected, are configured to use the 802.1X authentication method, ensure that you configure the OAW-IAPs to function as an 802.1X client or supplicant. If your network requires all wired devices to authenticate using PEAP or TLS protocol, you need to configure the OAW-IAP uplink ports for 802.1X authentication, so that the switch grants access to the OAW-IAP only after completing the authentication as a valid client.

To enable the 802.1X supplicant support on an OAW-IAP, ensure that the 802.1X authentication parameters are configured on all OAW-IAPs in the cluster and are stored securely in the OAW-IAP flash.



The 802.1X supplicant support feature is not supported with mesh and Wi-Fi uplink.

Configuring an OAW-IAP for 802.1X Supplicant Support

To enable 802.1X supplicant support, configure 802.1X authentication parameters on every OAW-IAP using the WebUI or the CLI.

In the Old WebUI

1. To use PEAP protocol-based 802.1X authentication method, complete the following steps:
 - a. In the **Access Points** tab, click the OAW-IAP on which you want to set the variables for 802.1X authentication, and then click the **edit** link.
 - b. In the **Edit Access Point** window, click the **Uplink** tab.
 - c. Under **PEAP user**, enter the username, password, and retype the password for confirmation. The OAW-IAP username and password are stored in OAW-IAP flash. When the OAW-IAP boots, the */tmp/ap1xuser* and */tmp/ap1xpassword* files are created based on these two variables.



The default inner authentication protocol for PEAP is MS-CHAPV2.

2. To upload server certificates for validating the authentication server credentials, complete the following steps:
 - a. Click **Upload New Certificate**.
 - b. Specify the URL from where you want to upload the certificates and select the type of certificate.
3. Click **OK**.
4. To configure 802.1X authentication on uplink ports of an OAW-IAP, complete the following steps:
 - a. Go to **System > Show advanced options > Uplink**.
 - b. Click AP1X.
 - c. Select **PEAP** or **TLS** in the **AP1X type** drop-down list.
 - d. If you want to validate the server credentials using server certificate, select the **Validate server** check box. Ensure that the server certificates for validating server credentials are uploaded to OAW-IAP database.
 - e. Click **OK**.
5. Reboot the OAW-IAP.

In the New WebUI

1. To use PEAP protocol-based 802.1X authentication method, complete the following steps:
 - a. In the **Configuration > Access Points** page, select the OAW-IAP on which you want to set the variables for 802.1X authentication, and click **Edit**.
 - b. In the **Edit Access Point <access point>** page, expand the **Uplink**.
 - c. Under **PEAP User**, enter a username, password, and retype the password for confirmation. The OAW-IAP username and password are stored in OAW-IAP flash. When the OAW-IAP boots, the */tmp/ap1xuser* and */tmp/ap1xpassword* files are created based on these two variables.



The default inner authentication protocol for PEAP is MS-CHAPV2.

2. To upload server certificates for validating the authentication server credentials, complete the following steps:
 - a. Expand **Upload Certificate**.
 - b. Specify the URL from where you want to upload the certificates and select the type of certificate.
3. Click **Upload Certificate**.
4. To configure 802.1X authentication on uplink ports of a nOAW-IAP, complete the following steps:
 - a. Go to **Configuration > System** page.
 - b. Click **Show advanced options** at the bottom of the page and expand **Uplink**.

- c. Under **AP1X**, select **PEAP** or **TLS** in the **AP1X type** drop-down list.
 - d. If you want to validate the server credentials using server certificate, toggle the **Validate server** switch to enable. Ensure that the server certificates for validating server credentials are uploaded to OAW-IAP database.
 - e. Click **Save**.
5. Reboot the OAW-IAP.

In the CLI

To set username and password variable used by the PEAP protocol-based 802.1X authentication:

```
(Instant AP) # aplx-peap-user <aplxuser> <password>
```

To set the PEAP 802.1X authentication type:

```
(Instant AP) (config) # aplx peap [validate-server]
```

To set TLS 802.1X authentication type:

```
(Instant AP) (config) # aplx tls <tpm|user> [validate-server]
```

To upload user or CA certificates for PEAP or TLS authentication:

```
(Instant AP) # copy tftp <addr> <file> aplx {ca|cert <password>} format pem
```

To download user or server certificates from a TFTP, FTP, or web server:

```
(Instant AP) # download aplx <url> format pem [psk <psk>]
(Instant AP) # download aplxca <url> format pem
```

To view the certificate details:

```
(Instant AP) # show aplxcert
```

To verify the configuration, use any of the following commands:

```
(Instant AP) # show aplx config
(Instant AP) # show aplx debug-logs
(Instant AP) # show aplx status
```

Configuring MAC Authentication for a Network Profile

MAC authentication can be used alone or it can be combined with other forms of authentication such as WEP authentication. However, it is recommended that you do not use the MAC-based authentication.

This section describes the following procedures:

- [Configuring MAC Authentication for Wireless Network Profiles on page 225](#)
- [Configuring MAC Authentication for Wired Profiles on page 227](#)

Configuring MAC Authentication for Wireless Network Profiles

You can configure MAC authentication for a wired profile in the WebUI or the CLI.

In the Old WebUI

To enable MAC Authentication for a wireless network:

1. On the **Networks** tab, click **New** to create a new network profile or select an existing profile for which you want to enable MAC authentication and click **edit**.
2. In the **Edit <profile-name>** or the **New WLAN** window, ensure that all required WLAN and VLAN attributes are defined, and then click **Next**.
3. On the **Security** tab, select **Enabled** from the **MAC authentication** drop-down list for the **Personal** or the **Open** security level.
4. In the **Authentication server 1** drop-down list, specify the type of authentication server to use.

5. If an internal authentication server is used, perform the following steps to allow MAC-address-based authentication:
 - a. Click the **Users** link beside the **Internal server** parameter. The **Users** window is displayed.
 - b. Specify the client MAC address as the username and password.
 - c. Specify the type of the user (employee or guest).
 - d. Click **Add**.
 - e. Repeat the steps to add more users.
 - f. Click **OK**.
6. To allow the OAW-IAP to use a delimiter in the MAC authentication request, specify a character (for example, colon or dash) as a delimiter for the MAC address string in the **Delimiter character** text box. For example, if you specify colon as the delimiter, MAC addresses in the xx:xx:xx:xx:xx:xx format are used. If the delimiter is not specified, the MAC address in the xxxxxxxxxxxx format is used.
7. To allow the OAW-IAP to use uppercase letters in the MAC address string, set **Uppercase support** to **Enabled**.



The **Delimiter character** and **Uppercase support** parameters are displayed only when MAC authentication is enabled.

8. Configure other parameters as required.
9. Click **Next** to define access rules, and then click **Finish** to apply the changes.

In the New WebUI

To enable MAC Authentication for a wireless network:

1. In the **Configuration > Networks** page, click **+** to create a new network profile or select an existing profile for which you want to enable MAC authentication and click **Edit**.
2. Ensure that all required WLAN and VLAN attributes are defined, and then click **Next**.
3. In the **Security** tab, toggle the **MAC authentication** switch for the **Personal** or the **Open** security level.
4. In the **Authentication server 1** drop-down list, specify the type of authentication server to use.
5. To allow the OAW-IAP to use a delimiter in the MAC authentication request, specify a character (for example, colon or dash) as a delimiter for the MAC address string in the **Delimiter character** text box. For example, if you specify colon as the delimiter, MAC addresses in the xx:xx:xx:xx:xx:xx format are used. If the delimiter is not specified, the MAC address in the xxxxxxxxxxxx format is used.
6. To allow the OAW-IAP to use uppercase letters in the MAC address string, toggle the **Uppercase support** switch to enable.



The **Delimiter character** and **Uppercase support** parameters are displayed only when MAC authentication is enabled.

7. Configure other parameters as required.
8. Click **Next** to define access rules, and then click **Finish** to apply the changes.

In the CLI

To configure MAC-address based authentication with external server:

```
(Instant AP) (config)# wlan ssid-profile <name>
(Instant AP) (SSID Profile <name>)# type {<Employee>|<Voice>|<Guest>}
(Instant AP) (SSID Profile <name>)# mac-authentication
(Instant AP) (SSID Profile <name>)# mac-authentication-delimiter <delim>
(Instant AP) (SSID Profile <name>)# mac-authentication-upper-case
```

```
(Instant AP) (SSID Profile <name>)# external-server
(Instant AP) (SSID Profile <name>)# auth-server <server-name1>
(Instant AP) (SSID Profile <name>)# auth-server <server-name2>
(Instant AP) (SSID Profile <name>)# server-load-balancing
(Instant AP) (SSID Profile <name>)# radius-reauth-interval <minutes>
```

To add users for MAC authentication based on internal authentication server:

```
(Instant AP) (config)# user <username> [<password>] [portal|radius]
```

Configuring MAC Authentication for Wired Profiles

You can configure MAC authentication for a wired profile in the WebUI or the CLI.

In the Old WebUI

To enable MAC authentication for a wired profile:

1. Click the **Wired** link under **More** in the main window. The **Wired** window is displayed.
2. Click **New** under **Wired Networks** to create a new network or select an existing profile for which you want to enable MAC authentication and then click **Edit**.
3. In the **New Wired Network** or the **Edit Wired Network** window, ensure that all the required wired and VLAN attributes are defined, and then click **Next**.
4. Under **Security** tab, select **Enabled** from the **MAC authentication** drop-down list.
5. In the **Authentication server 1** drop-down list, specify the type of authentication server to use.
6. If an internal authentication server is used, perform the following steps to allow MAC-address-based authentication:
 - a. Click the **Users** link beside **Internal server**. The **Users** window is displayed.
 - b. Specify the client MAC address as the username and password.
 - c. Specify the type of the user (employee or guest).
 - d. Click **Add**.
 - e. Repeat the steps to add more users.
 - f. Click **OK**.
7. Configure other parameters as required.
8. Click **Next** to define access rules, and then click **Finish** to apply the changes.

In the New WebUI

To enable MAC authentication for a wired profile:

1. In the **Configuration > Networks** page, click **+** to create a new network profile or select an existing profile for which you want to enable MAC authentication and click **Edit**.
2. Ensure that all required wired and VLAN attributes are defined, and then click **Next**.
3. Under **Security** tab, toggle the **MAC authentication** switch to enable.
4. In the **Authentication server 1** drop-down list, specify the type of authentication server to use.
5. Configure other parameters as required.
6. Click **Next** to define access rules, and then click **Finish** to apply the changes.

In the CLI

To configure MAC-address-based authentication with external server:

```
(Instant AP) (config)# wired-port-profile <name>
(Instant AP) (wired ap profile <name>)# type {<employee>|<guest>}
(Instant AP) (wired ap profile <name>)# mac-authentication
```

```
(Instant AP) (wired ap profile <name>)# auth-server <server-1>
(Instant AP) (wired ap profile <name>)# auth-server <server-2>
(Instant AP) (wired ap profile <name>)# server-load-balancing
(Instant AP) (wired ap profile <name>)# radius-reauth-interval <Minutes>
```

To add users for MAC authentication based on internal authentication server:

```
(Instant AP) (config)# user <username> [<password>] [portal|radius]
```

Configuring MAC Authentication with 802.1X Authentication

This section describes the following procedures:

- [Configuring MAC and 802.1X Authentications for Wireless Network Profiles on page 228](#)
- [Configuring MAC and 802.1X Authentications for Wired Profiles on page 229](#)

Configuring MAC and 802.1X Authentications for Wireless Network Profiles

You can configure MAC authentication with 802.1X authentication for a wireless network profile using the WebUI or the CLI.

In the Old WebUI

1. On the **Networks** tab, click **New** to create a new network profile or select an existing profile for which you want to enable MAC and 802.1X authentications and click **edit**.
2. In the **Edit <profile-name>** or the **New WLAN** window, ensure that all required WLAN and VLAN attributes are defined, and then click **Next**.
3. On the **Security** tab, move the slider to the **Enterprise** security level. Ensure that the required parameters for MAC authentication and 802.1X authentication are configured.
4. Select the **Perform MAC authentication before 802.1X** check box to use 802.1X authentication only when the MAC authentication is successful.
5. Select the **MAC authentication fail-thru** check box to use 802.1X authentication even when the MAC authentication fails.
6. Click **Next** and then click **Finish** to apply the changes.

In the New WebUI

1. In the **Configuration > Networks** section, click + to create a new network profile or select an existing profile for which you want to enable MAC and 802.1X authentications and click **Edit**.
2. Ensure that all required WLAN and VLAN attributes are defined, and then click **Next**.
3. Under **Security** tab, select **Enterprise** from the **Security Level** drop-down list. Ensure that the required parameters for MAC authentication and 802.1X authentication are configured.
4. Select the **Perform MAC authentication before 802.1X** check box to use 802.1X authentication only when the MAC authentication is successful.
5. Select the **MAC authentication fail-thru** check box to use 802.1X authentication even when the MAC authentication fails.
6. Click **Next** and until **Finish** to apply the changes.

In the CLI

```
(Instant AP) (config)# wlan ssid-profile <name>
(Instant AP) (SSID Profile <name>)# type {<Employee>|<Voice>|<Guest>}
(Instant AP) (SSID Profile <name>)# mac-authentication
(Instant AP) (SSID Profile <name>)# l2-auth-failthrough
(Instant AP) (SSID Profile <name>)# auth-server <server-name1>
(Instant AP) (SSID Profile <name>)# radius-reauth-interval <minutes>
```

```
(Instant AP) (SSID Profile <name>)# auth-survivability
(Instant AP) (SSID Profile <name>)# exit
(Instant AP) (config)# auth-survivability cache-time-out <hours>
```

Configuring MAC and 802.1X Authentications for Wired Profiles

You can configure MAC and 802.1X authentications for a wired profile in the WebUI or the CLI.

In the Old WebUI

To enable MAC and 802.1X authentications for a wired profile:

1. Click the **Wired** link under **More** in the main window. The **Wired** window is displayed.
2. Click **New** under **Wired Networks** to create a new network or select an existing profile for which you want to enable MAC authentication and then click **Edit**.
3. In the **New Wired Network** or the **Edit Wired Network** window, ensure that all the required wired and VLAN attributes are defined, and then click **Next**.
4. On the **Security** tab, perform the following steps:
 - Select **Enabled** from the **MAC authentication** drop-down list.
 - Select **Enabled** from the **802.1X authentication** drop-down list.
 - Select **Enabled** from the **MAC authentication fail-thru** drop-down list.
5. In the **Authentication server 1** drop-down list, specify the type of authentication server to use and configure other required parameters. For more information on configuration parameters, see [Configuring Security Settings for a Wired Profile on page 137](#).
6. Click **Next** to define access rules, and then click **Finish** to apply the changes.

In the New WebUI

To enable MAC and 802.1X authentications for a wired profile:

1. In the **Configuration > Networks** section, click + to create a new network profile or select an existing profile for which you want to enable MAC and 802.1X authentications and click **Edit**.
2. Ensure that all required WLAN and VLAN attributes are defined, and then click **Next**.
3. Under **Security** tab, perform the following steps:
 - Toggle the **MAC authentication** switch to enable.
 - Toggle the **802.1X authentication** switch to enable.
 - Toggle the **MAC authentication fail-thru** switch to enable.
4. In the **Authentication server 1** drop-down list, specify the type of authentication server to use and configure other required parameters. For more information on configuration parameters, see [Configuring Security Settings for a Wired Profile on page 137](#).
5. Click **Next** to define access rules, and then click **Finish** to apply the changes.

In the CLI

To enable MAC and 802.1X authentications for a wired profile:

```
(Instant AP) (config)# wired-port-profile <name>
(Instant AP) (wired ap profile "<name>")# type {<employee>|<guest>}
(Instant AP) (wired ap profile "<name>")# mac-authentication
(Instant AP) (wired ap profile "<name>")# dot1x
(Instant AP) (wired ap profile "<name>")# l2-auth-failthrough
(Instant AP) (wired ap profile "<name>")# auth-server <name>
(Instant AP) (wired ap profile "<name>")# server-load-balancing
(Instant AP) (wired ap profile "<name>")# radius-reauth-interval <Minutes>
```

Configuring MAC Authentication with Captive Portal Authentication

The following configuration conditions apply to MAC + captive portal authentication method:

- If the captive portal splash page type is **Internal-Authenticated** or **External-RADIUS Server**, MAC authentication reuses the server configurations.
- If the captive portal splash page type is **Internal-Acknowledged** or **External-Authentication Text** and MAC authentication is enabled, a server configuration page is displayed.

You can configure the MAC authentication with captive portal authentication for a network profile using the WebUI or the CLI.

In the Old WebUI

1. Select an existing wireless or wired profile for which you want to enable MAC with captive portal authentication. Depending on the network profile selected, the **Edit <WLAN-Profile>** or the **Edit Wired Network** window is displayed.



To enable MAC authentication with captive portal authentication on a new WLAN SSID or wired profile, click the **Security** tab on the **New WLAN** window and the **New Wired Network** window.

2. On the **Security** tab, specify the following parameters:
 - a. Select **Enabled** from the **MAC authentication** drop-down list to enable MAC authentication for captive portal users. If the MAC authentication fails, the captive portal authentication role is assigned to the client.
 - b. In case of a wired profile, select the **802.1X authentication** check box in addition to **MAC authentication**.
 - c. To enforce MAC authentication, click the **Access** tab and select **Enforce MAC auth only role** check box.
3. Click **Next** and then click **Finish** to apply the changes.

In the New WebUI

1. In the **Configuration > Networks** section, click **+** to create a new network profile or select an existing profile for which you configure internal captive portal authentication for a WLAN SSID or a wired profile and click **Edit**.



To enable MAC authentication with captive portal authentication on a new WLAN SSID or wired profile, click the **Security** tab on the **Create new network** window.

2. Select the **Security** tab and specify the following parameters:
 - a. Toggle the **MAC authentication** switch to enable MAC authentication for captive portal users. If the MAC authentication fails, the captive portal authentication role is assigned to the client.
 - b. In case of a wired profile for employee access, toggle the **802.1X authentication** switch to enable. This is in addition to enabling MAC authentication.
 - c. In case of a wired profile for guess access, select a profile from the **Captive portal profile** drop-down list. This is in addition to enabling MAC authentication.
 - d. To enforce MAC authentication, go to the **Access** tab, select **Role-based** from the **Access Rules** drop-down list, and toggle the **Enforce MAC auth only role** switch to enable.
3. Click **Next** and then click **Finish** to apply the changes.



The **Enforce MAC auth only role** parameter is not supported on a WLAN profile for employee access.

In the CLI

To configure MAC authentication with captive portal authentication for a wireless profile:

```
(Instant AP) (config)# wlan ssid-profile <name>
(Instant AP) (SSID Profile <name>)# type <guest>
(Instant AP) (SSID Profile <name>)# mac-authentication
(Instant AP) (SSID Profile <name>)# captive-portal {<type> [exclude-uplink <types>]}|external
[Profile <name>] [exclude-uplink <types>]}
(Instant AP) (SSID Profile <name>)# set-role-mac-auth <mac-only>
```

To configure MAC authentication with captive portal authentication for a wired profile:

```
(Instant AP) (config)# wired-port-profile <name>
(Instant AP) (wired ap profile <name>)# type <guest>
(Instant AP) (wired ap profile <name>)# mac-authentication
(Instant AP) (wired ap profile <name>)# captive-portal <type>
(Instant AP) (wired ap profile <name>)# captive-portal {<type> [exclude-uplink
<types>]}|external [Profile <name>] [exclude-uplink <types>]}
(Instant AP) (wired ap profile <name>)# set-role-mac-auth <mac-only>
```

Configuring WISPr Authentication

AOS-W Instant supports the following smart clients:

- iPass
- Boingo

These smart clients enable client authentication and roaming between hotspots by embedding iPass Generic Interface Specification *redirect*, *authentication*, and *logout* messages within HTML messages that are sent to the OAW-IAP.



WISPr authentication is supported only for the **Internal - Authenticated** and **External** captive portal authentication. Select the **Internal - Authenticated** or the **External** option from the **Splash page type** drop-down list to configure WISPr authentication for a WLAN profile.

You can configure WISPr authentication using the WebUI or the CLI.

In the Old WebUI

1. Click the **System** link located directly above the Search bar in the AOS-W Instant main window. The **System** window is displayed.
2. Click **Show advanced options**.
3. Click **WISPr** tab. The **WISPr** tab contents are displayed.
4. Enter the ISO Country Code for the WISPr Location ID in the **ISO country code** text box.
5. Enter the E.164 Area Code for the WISPr Location ID in the **E.164 area code** text box.
6. Enter the operator name of the hotspot in the **Operator name** text box.
7. Enter the E.164 Country Code for the WISPr Location ID in the **E.164 country code** text box.
8. Enter the SSID or the zone name for the WISPr Location ID in the **SSID/Zone** text box.
9. Enter the name of the Hotspot location in the **Location name** text box. If no name is defined, the name of the OAW-IAP to which the user is associated is used.
10. Click **OK** to apply the changes.

In the New WebUI

1. Navigate to the **Configuration > System** page.
2. Click **Show advanced options** at the bottom of the page.
3. Expand **WISPr**.
4. In the **ISO country code** text box enter the ISO Country Code for the WISPr Location ID.
5. In the **E.164 country code** text box enter the E.164 Country Code for the WISPr Location ID.
6. In the **E.164 area code** text box enter the E.164 Area Code for the WISPr Location ID.
7. In the **SSID/Zone** text box enter the SSID or the zone name for the WISPr Location ID.
8. In the **Operator name** text box enter the operator name of the hotspot.
9. In the **Location name** text box enter the name of the Hotspot location. If no name is defined, the name of the OAW-IAP to which the user is associated is used.
10. Click **Save** to apply the changes.

The WISPr RADIUS attributes and configuration parameters are specific to the RADIUS server used by your ISP for the WISPr authentication. Contact your ISP to determine these values. You can find a list of ISO and ITU country and area codes at the ISO and ITU websites (www.iso.org and <http://www.itu.int>).



A Boingo smart client uses a NAS identifier in the <CarrierID>_<VenueID> format for location identification. To support Boingo clients, ensure that you configure the NAS identifier parameter in the RADIUS server profile for the WISPr server.

In the CLI

```
(Instant AP) (config)# wlan wispr-profile
(Instant AP) (WISPr)# wispr-location-id-ac
(Instant AP) (WISPr)# wispr-location-id-cc
(Instant AP) (WISPr)# wispr-location-id-isocc
(Instant AP) (WISPr)# wispr-location-id-network
(Instant AP) (WISPr)# wispr-location-name-location
(Instant AP) (WISPr)# wispr-location-name-operator-name
```

Blacklisting Clients

The client blacklisting denies connection to the blacklisted clients. When a client is blacklisted, it is not allowed to associate with an OAW-IAP in the network. If a client is connected to the network when it is blacklisted, a deauthentication message is sent to force client disconnection.

This section describes the following procedures:

- [Blacklisting Clients Manually on page 232](#)
- [Blacklisting Users Dynamically on page 233](#)

Blacklisting Clients Manually

Manual blacklisting adds the MAC address of a client to the blacklist. These clients are added into a permanent blacklist. These blacklisted clients are not allowed to connect to the network unless they are removed from the blacklist.

You can add a client to the blacklist manually using the WebUI or the CLI.

In the Old WebUI

1. Click the **Security** link located directly above the Search bar in the AOS-W Instant main window.
2. Click the **Blacklisting** tab.

3. Under **Manual Blacklisting**, click **New**.
4. Enter the MAC address of the client to be blacklisted in the **MAC address to add** text box.



For the blacklisting to take effect on the MAC address, you must enable blacklisting in the SSID profile. For more information, see [Blacklisting on page 113](#).

5. Click **OK**. The **Blacklisted Since** column in the **Manual Blacklist** window displays the time at which the current blacklisting has started for the client.
6. To delete a client from the manual blacklist, select the MAC Address of the client under the **Manual Blacklist** window, and then click **Delete**.

In the New WebUI

1. Navigate to the **Configuration > Security** page.
2. Expand **Blacklisting**.
3. Under **Manual Blacklisting**, click **+**.
4. Enter the MAC address of the client to be blacklisted in the **MAC address to add** text box.



For the blacklisting to take effect on the MAC address, you must enable blacklisting in the SSID profile. For more information, see [Blacklisting on page 113](#).

5. Click **OK**. The **Blacklisted Since** column in the **Manual Blacklist** window displays the time at which the current blacklisting has started for the client.
6. To delete a client from the manual blacklist, select the MAC Address of the client under the **Manual Blacklist** window and click **Delete**.
7. Click **Save**.

In the CLI

To blacklist a client:

```
(Instant AP) (config)# blacklist-client <MAC-Address>
```

To enable blacklisting in the SSID profile:

```
(Instant AP) (config)# wlan ssid-profile <name>
(Instant AP) (SSID Profile <name>)# blacklisting
```

To view the blacklisted clients:

```
(Instant AP)# show blacklist-client
Blacklisted Clients
```

```
-----
MAC                Reason          Timestamp      Remaining time(sec)  AP name
---                -
00:1c:b3:09:85:15  user-defined    17:21:29      Permanent            -
```

Blacklisting Users Dynamically

The clients can be blacklisted dynamically when they exceed the authentication failure threshold or when a blacklisting rule is triggered as part of the authentication process.

Authentication Failure Blacklisting

When a client takes time to authenticate and exceeds the configured failure threshold, it is automatically blacklisted by an OAW-IAP.

Session Firewall-Based Blacklisting

In session firewall-based blacklisting, an ACL rule is used to enable the option for dynamic blacklisting. When the ACL rule is triggered, it sends out blacklist information and the client is blacklisted.

Configuring Blacklist Duration

You can set the blacklist duration using the WebUI or the CLI.

In the Old WebUI

To set a blacklist duration:

1. Click the **Security** link located directly above the Search bar in the AOS-W Instant main window.
2. Click the **Blacklisting** tab.
3. Under **Dynamic Blacklisting**:
4. For **Auth failure blacklist time**, the duration in seconds after which the clients that exceed the authentication failure threshold must be blacklisted.
5. For **PEF rule blacklisted time**, enter the duration in seconds after which the clients can be blacklisted due to an ACL rule trigger.
6. Click **OK**.

You can configure a maximum number of authentication failures by the clients, after which a client must be blacklisted. For more information on configuring maximum authentication failure attempts, see [Configuring Security Settings for a WLAN SSID Profile on page 111](#).



To enable session-firewall-based blacklisting, click **New** in the **Networks** tab and navigate to **WLAN Settings > VLAN > Security > Access** window, and click the **Blacklist** check box of the corresponding ACL rule.

In the New WebUI

To set a blacklist duration:

1. Navigate to the **Configuration > Security** page.
2. Expand **Blacklisting**.
3. Expand **Dynamic Blacklisting**.
4. In the **Auth failure blacklist time** field enter the duration after which the clients must be blacklisted.
5. In the **PEF rule blacklisted time** field enter the duration after which the clients can be blacklisted due to an ACL rule trigger.
6. Click **Save**.

You can configure a maximum number of authentication failures by the clients, after which a client must be blacklisted. For more information on configuring maximum authentication failure attempts, see [Configuring Security Settings for a WLAN SSID Profile on page 111](#).



To enable session-firewall-based blacklisting, click + in the **Configuration > Networks** tab, navigate to the **Basic > VLAN > Security > Access** window, click + under **Access Rules for <network>** and click the **Blacklist** check box in the **New rule** window.

In the CLI

To dynamically blacklist clients:

```
(Instant AP) (config)# auth-failure-blacklist-time <seconds>
(Instant AP) (config)# blacklist-time <seconds>
```

To enable blacklisting in the SSID profile:

```
(Instant AP) (config)# wlan ssid-profile <name>
```

```
(Instant AP) (SSID Profile <name>)# blacklisting
```

To view the blacklisted clients:

```
(Instant AP)# show blacklist-client config
Blacklist Time           :60
Auth Failure Blacklist Time :60
Manually Blacklisted Clients
-----
MAC   Time
---  ----
Dynamically Blacklisted Clients
-----
MAC   Reason   Timestamp   Remaining time(sec)  AP IP
---   -
Dyn Blacklist Count   :0
```

Uploading Certificates

A certificate is a digital file that certifies the identity of the organization or products of the organization. It is also used to establish your credentials for any web transactions. It contains the organization name, a serial number, expiration date, a copy of the certificate-holder's public key, and the digital signature of the certificate-issuing authority so that a recipient can ensure that the certificate is real.

There is a default server certificate installed in the switch to demonstrate the authentication of the switch for Captive Portal and WebUI management access. However, this certificate does not guarantee security in production networks. Alcatel-Lucent strongly recommends that you replace the default certificate with a custom certificate issued for your site or domain by a trusted CA.

AOS-W Instant supports the following certificate files:

- Authentication server (PEM format)
- Captive portal server (PEM format)—Customized certificate for internal captive portal server
- CA certificate (PEM or DER format)
- RadSec certificate (PEM or DER format)
- WebUI certificate (PEM format)

This section describes the following procedures:

- [Loading Certificates In the Old WebUI on page 235](#)
- [Loading Certificates In the New WebUI on page 236](#)
- [Loading Certificates Through AOS-W Instant CLI on page 236](#)
- [Removing Certificates on page 237](#)
- [Loading Certificates Through OmniVista 3600 Air Manager on page 237](#)

Loading Certificates In the Old WebUI

To load a certificate in the Old WebUI:

1. Click the **Maintenance** link located directly above the Search bar in the AOS-W Instant main window.
2. Click the **Certificates** tab. The **Certificates** tab contents are displayed.
3. To upload a certificate, click **Upload New Certificate**. The **New Certificate** window is displayed.
4. Browse and select the file to upload.
5. Select any of the following types of certificates from the **Certificate type** drop-down list:
 - **CA**—CA certificate to validate the identity of the client.
 - **Auth Server**—The authentication server certificate to verify the identity of the server to the client.

- **Captive portal server**—Captive portal server certificate to verify the identity of internal captive portal server to the client.
 - **RadSec**—The RadSec server certificate to verify the identity of the server to the client.
 - **RadSec CA**—The RadSec CA certificate for mutual authentication between the OAW-IAP clients and the TLS server.
 - **WebUI**—Customized certificate for WebUI management.
6. Select the certificate format from the **Certificate format** drop-down list.
 7. If you have selected **Auth Server**, **Captive portal server**, **WebUI**, or **RadSec** as the type of certificate, enter a passphrase in **Passphrase** and retype the passphrase. If the certificate does not include a passphrase, there is no passphrase required.
 8. Click **Browse** and select the appropriate certificate file, and click **Upload Certificate**. The **Certificate Successfully Installed** message is displayed.

Loading Certificates In the New WebUI

To load a certificate in the New WebUI:

1. Navigate to the **Maintenance > Certificates** page.
2. To upload a certificate, click **Upload New Certificate**. The **New Certificate** window is displayed.
3. Browse and select the file to upload.
4. Select any of the following types of certificates from the **Certificate type** drop-down list:
 - **CA**—CA certificate to validate the identity of the client.
 - **Auth Server**—The authentication server certificate to verify the identity of the server to the client.
 - **Captive portal server**—Captive portal server certificate to verify the identity of internal captive portal server to the client.
 - **RadSec**—The RadSec server certificate to verify the identity of the server to the client.
 - **RadSec CA**—The RadSec CA certificate for mutual authentication between the OAW-IAP clients and the TLS server.
 - **WebUI**—Customized certificate for WebUI management.
5. Select the certificate format from the **Certificate format** drop-down list.
6. If you have selected **Auth Server**, **Captive portal server**, **WebUI**, or **RadSec** as the type of certificate, enter a passphrase in **Passphrase** and retype the passphrase. If the certificate does not include a passphrase, there is no passphrase required.
7. Click **Browse** and select the appropriate certificate file, and click **Upload Certificate**. The **Certificate Successfully Installed** message is displayed.

The OAW-IAP database can have only one authentication server certificate and one captive portal server certificate at any point in time.



When a Captive Portal server certificate is uploaded with the **WebUI** option selected, the default management certificate on the AOS-W Instant WebUI is also replaced by the Captive portal server certificate.

Loading Certificates Through AOS-W Instant CLI

To upload a CA, server, WebUI, or captive portal certificate:

```
(Instant AP)# copy tftp <ip-address> <filename> {cpserver cert <password> format {p12|pem}|
radsec {ca|cert <password>} format pem|system {1xca format {der|pem}| 1xcert <password> format
pem} uiserver cert <password> format pem}
```

To download RadSec certificates:

```
(Instant AP)# download-cert radsec ftp://192.0.2.7 format pem [psk <psk>]
```

```
(Instant AP)# download-cert radsecca ftp://192.0.2.7 format pem
```

Removing Certificates

To clear a certificate:

```
(Instant AP)# clear-cert {ca|cp|radsec|radsecca|server}
```

Loading Certificates Through OmniVista 3600 Air Manager

You can manage certificates using OmniVista 3600 Air Manager. The AMP directly provisions the certificates and performs basic certificate verification (such as certificate type, format, version, serial number, and so on) before accepting the certificate and uploading to an OAW-IAP network. The AMP packages the text of the certificate into an HTTPS message and sends it to the virtual switch. After the virtual switch receives this message, it draws the certificate content from the message, converts it to the right format, and saves it on the RADIUS server.

To load a certificate in OmniVista 3600 Air Manager:

1. Navigate to **Device Setup > Certificates** and then click **Add** to add a new certificate. The **Certificate** window is displayed.
2. Enter the certificate **Name**, and click **Choose File** to browse and upload the certificate.
3. Select the appropriate **Format** that matches the certificate filename.
 - Select **Server Cert** for certificate **Type**, and provide the passphrase if you want to upload a server certificate.
 - Select either **Intermediate CA** or **Trusted CA** certificate **Type**, if you want to upload a CA certificate.
4. After you upload the certificate, navigate to **Groups**, click the Instant **Group** and then select **Basic**. The Group name is displayed only if you have entered the **Organization** name in the WebUI. For more information, see [Configuring Organization String on page 415](#) for further information.

The **Virtual Controller Certificate** section displays the certificates (CA cert and Server).

5. Click **Save** to apply the changes only to OmniVista 3600 Air Manager. Click **Save and Apply** to apply the changes to the OAW-IAP.
6. To clear the certificate options, click **Revert**.

Loading Customized Certificates from OmniVista 3600 Air Manager

OmniVista 3600 Air Manager also provides users with the option of uploading customized certificates on the OAW-IAP. The customized certificate is uploaded on OmniVista 3600 Air Manager and then pushed to the OAW-IAP from the OmniVista 3600 Air Manager UI.

- Before uploading the new customized certificate, ensure that you uninstall any existing customized certificates on the OAW-IAP:

```
(Instant AP)# clear-cert-airwaveca
```
- Upload the customized certificate to OmniVista 3600 Air Manager and push it to the OAW-IAP. Refer to [Loading Certificates Through OmniVista 3600 Air Manager on page 237](#)
- Once the new customized certificate is uploaded to the OAW-IAP, verify the certification installation using the following command:

```
(Instant AP)# show ap checksum
```

Perform these steps after you have verified that the new customized certificate is successfully installed on the OAW-IAP:

1. Delete PSK configuration from the OAW-IAP using the following command:

```
(Instant AP)(config)# no ams-key
```
2. Add a DNS server and link the AMP IP address with the domain name of the new customized certificate.

3. Configure the AMP IP address

```
(Instant AP) (config)# ams-ip <domain_name>
```

4. In the OmniVista 3600 Air Manager UI, navigate to **AMP Setup > General > Aruba Instant Options > Change SSL Change** and click **Change**. Ensure you delete the ams-key for **cert-only mode** or **cert and psk mode**.

5. Add the OAW-IAP to AMP again.

This chapter describes the procedures for configuring user roles, role assignment, and firewall policies.

- [Firewall Policies on page 239](#)
- [Content Filtering on page 255](#)
- [Configuring User Roles on page 260](#)
- [Configuring Derivation Rules on page 264](#)
- [Using Advanced Expressions in Role and VLAN Derivation Rules on page 272](#)

Firewall Policies

AOS-W Instant firewall provides identity-based controls to enforce application-layer security, prioritization, traffic forwarding, and network performance policies for wired and wireless networks. Using AOS-W Instant firewall, you can enforce network access policies that define access to the network, areas of the network that users may access, and the performance thresholds of various applications.

AOS-W Instant supports a role-based stateful firewall. AOS-W Instant firewall recognizes flows in a network and keeps track of the state of sessions. Instant firewall manages packets according to the first rule that matches the packet. The firewall logs on the OAW-IAPs are generated as syslog messages.

ACL Rules

You can use ACL rules to either permit or deny data packets passing through the OAW-IAP. You can also limit packets or bandwidth available to a set of user roles by defining access rules. By adding custom rules, you can block or allow access based on the service or application, source or destination IP addresses.

You can create access rules to allow or block data packets that match the criteria defined in an access rule. You can create rules for either inbound traffic or outbound traffic. Inbound rules explicitly allow or block the inbound network traffic that matches the criteria in the rule. Outbound rules explicitly allow or block the network traffic that matches the criteria in the rule. For example, you can configure a rule to explicitly block outbound traffic to an IP address through the firewall.

The OAW-IAP clients are associated with user roles, that determine the client's network privileges and the frequency at which clients re-authenticate.

AOS-W Instant supports the following types of ACLs:

- ACLs that permit or deny traffic based on the source IP address of the packet.
- ACLs that permit or deny traffic based on the source or destination IP address, and the source or destination port number.
- ACLs that permit or deny traffic based on network services, application, application categories, web categories, and security ratings.



You can configure up to 256 access control entries in an ACL for a user role.

The maximum configurable universal role is 2048.

Configuring ACL Rules for Network Services

This section describes the procedure for configuring ACLs to control access to network services.

- For information on configuring access rules based on application and application categories, see [Configuring ACL Rules for Application and Application Categories on page 362](#).
- For information on configuring access rules based on web categories and web reputation, see [Configuring Web Policy Enforcement Service on page 367](#).

In the Old WebUI

To configure ACL rules for a user role:

1. Navigate to **Security > Roles**. The **Roles** tab contents are displayed.

Alternatively, you can configure access rules for a wired or wireless client through the WLAN wizard or the Wired Profile window.

a. To configure access rules through the Wired Profile window:

- Navigate to **More > Wired**.
- Click **Edit** and then **Edit Wired Network**.
- Click **Access**.

b. To configure access rules through WLAN wizard:

- Navigate to **Network > WLAN SSID**.
- Click **Edit** and then **Edit WLAN**.
- Click **Access**.

2. Select the role for which you want to configure access rules.
3. In the **Access rules** section, click **New** to add a new rule. The **New Rule** window is displayed.
4. Ensure that the rule type is set to **Access Control**.

The maximum roles configurable on an OAW-IAP is 32.

The maximum ACL entries supported is 2048.

The maximum ACL entries for each role is 256.



5. To configure a rule to control access to network services, select **Network** under the **Service** category and specify the following parameters:

Table 56: Access Rule Configuration Parameters

Service Category	Description
Network	<p>Select a service from the list of available services. You can allow or deny access to any or all of the services based on your requirement:</p> <ul style="list-style-type: none"> ■ any—Access is allowed or denied to all services. ■ custom—Available protocols are TCP, UDP, ethernet, and Other. If you select the TCP or UDP protocol, enter appropriate port numbers. If you select the Other option, enter the appropriate ID. If you select the ethernet option, specify the ethernet type. <p>NOTE: If TCP and UDP use the same port, ensure that you configure separate access rules to permit or deny access.</p>
Action	<p>Select any of following actions:</p> <ul style="list-style-type: none"> ■ Select Allow to allow access to users based on the access rule. ■ Select Deny to deny access to users based on the access rule. ■ Select Destination-NAT to allow making changes to the destination IP address. ■ Select Source-NAT to allow making changes to the source IP address. <ul style="list-style-type: none"> ● Default: All client traffic is directed to the default VLAN. ● Tunnel: The traffic from the Network Assigned clients is directed to the VPN tunnel. ● VLAN: Specify the non-default VLAN ID to which the guest traffic needs to be redirected to.
Destination	<p>Select a destination option for the access rules for network services, applications, and application categories. You can allow or deny access to any the following destinations based on your requirements.</p> <ul style="list-style-type: none"> ■ to all destinations— Access is allowed or denied to all destinations. ■ to a particular server—Access is allowed or denied to a particular server. After selecting this option, specify the IP address of the destination server. ■ except to a particular server—Access is allowed or denied to servers other than the specified server. After selecting this option, specify the IP address of the destination server. ■ to a network—Access is allowed or denied to a network. After selecting this option, specify the IP address and netmask for the destination network. ■ except to a network—Access is allowed or denied to networks other than the specified network. After selecting this option, specify the IP address and netmask of the destination network. ■ to domain name—Access is allowed or denied to the specified domains. After selecting this option, specify the domain name in the Domain Name text box.
Log	<p>Select the Log check box if you want a log entry to be created when this rule is triggered. AOS-W Instant supports firewall-based logging. Firewall logs on the OAW-IAPs are generated as security logs.</p>
Blacklist	<p>Select the Blacklist check box to blacklist the client when this rule is triggered. The blacklisting lasts for the duration specified as Auth failure blacklist time on the Blacklisting tab of the Security window. For more information, see Blacklisting Clients on page 232.</p>
Disable scanning	<p>Select Disable scanning check box to disable ARM scanning when this rule is triggered. The selection of Disable scanning applies only if ARM scanning is enabled. For more information, see Configuring Radio Settings on page 354.</p>
DSCP tag	<p>Select the DSCP tag check box to specify a DSCP value to prioritize traffic when this rule is triggered. Specify a value within the range of 0–63. To assign a higher priority, specify a higher value.</p>
802.1p priority	<p>Select the 802.1p priority check box to specify an 802.1p priority. Specify a value between 0 and 7. To assign a higher priority, specify a higher value.</p> <p>NOTE: This parameter is applicable only for VLAN tagged frames.</p>

6. Click **OK** in the **New Rule** window and then click **OK** in the **Roles** tab.

In the New WebUI

To configure ACL rules for a user role:

1. Navigate to **Configuration > Security > Roles**. The **Roles** tab contents are displayed.

Alternatively, you can configure access rules for a wired or wireless client through the WLAN wizard or the Wired Profile window.

- To configure access rules for a wired or wireless client, go to **Configuration > Networks** tab. Click **+** to create a new network or select the network profile to modify an existing profile.
 - Go to the **Access** tab.
2. Select the role for which you want to configure access rules.
3. In the **Access rules** section, click **+** to add a new rule. The **New rule** window is displayed.
4. Ensure that the rule type is set to **Access Control**.

The maximum roles configurable on an OAW-IAP is 32.

The maximum ACL entries supported is 2048.

The maximum ACL entries for each role is 256.



5. To configure a rule to control access to network services, select **Network** under the **Service** category and specify the following parameters:

Table 57: Access Rule Configuration Parameters

Service Category	Description
Network	<p>Select a service from the list of available services. You can allow or deny access to any or all of the services based on your requirement:</p> <ul style="list-style-type: none"> ■ any—Access is allowed or denied to all services. ■ custom—Available protocols are TCP, UDP, ethernet, and Other. If you select the TCP or UDP protocol, enter appropriate port numbers. If you select the Other option, enter the appropriate ID. If you select the ethernet option, specify the ethernet type. <p>NOTE: If TCP and UDP use the same port, ensure that you configure separate access rules to permit or deny access.</p>
Action	<p>Select any of following actions:</p> <ul style="list-style-type: none"> ■ Select Allow to allow access to users based on the access rule. ■ Select Deny to deny access to users based on the access rule. ■ Select Destination-NAT to allow making changes to the destination IP address. ■ Select Source-NAT to allow making changes to the source IP address. <ul style="list-style-type: none"> ● Default: All client traffic is directed to the default VLAN. ● Tunnel: The traffic from the Network Assigned clients is directed to the VPN tunnel. ● VLAN: Specify the non-default VLAN ID to which the guest traffic needs to be redirected to.
Destination	<p>Select a destination option for the access rules for network services, applications, and application categories. You can allow or deny access to any the following destinations based on your requirements.</p> <ul style="list-style-type: none"> ■ to all destinations— Access is allowed or denied to all destinations. ■ to a particular server—Access is allowed or denied to a particular server. After selecting this option, specify the IP address of the destination server. ■ except to a particular server—Access is allowed or denied to servers other than

Table 57: Access Rule Configuration Parameters

Service Category	Description
	<p>the specified server. After selecting this option, specify the IP address of the destination server.</p> <ul style="list-style-type: none"> ■ to a network—Access is allowed or denied to a network. After selecting this option, specify the IP address and netmask for the destination network. ■ except to a network—Access is allowed or denied to networks other than the specified network. After selecting this option, specify the IP address and netmask of the destination network. ■ to domain name—Access is allowed or denied to the specified domains. After selecting this option, specify the domain name in the Domain Name text box.
Log	Select the Log check box if you want a log entry to be created when this rule is triggered. AOS-W Instant supports firewall-based logging. Firewall logs on the OAW-IAPs are generated as security logs.
Blacklist	Select the Blacklist check box to blacklist the client when this rule is triggered. The blacklisting lasts for the duration specified as Auth failure blacklist time on the Blacklisting tab of the Security window. For more information, see Blacklisting Clients on page 232 .
Disable scanning	Select Disable scanning check box to disable ARM scanning when this rule is triggered. The selection of Disable scanning applies only if ARM scanning is enabled. For more information, see Configuring Radio Settings on page 354 .
DSCP tag	Select the DSCP tag check box to specify a DSCP value to prioritize traffic when this rule is triggered. Specify a value within the range of 0–63. To assign a higher priority, specify a higher value.
802.1p priority	Select the 802.1p priority check box to specify an 802.1p priority. Specify a value between 0 and 7. To assign a higher priority, specify a higher value. NOTE: This parameter is applicable only for VLAN tagged frames.

6. Click **OK** in the **New Rule** window and then click **Save**.

In the CLI

To configure access rules:

```
(Instant AP) (config)# wlan access-rule <access-rule-name>
(Instant AP) (Access Rule <Name>)#rule <dest> <mask> <match/invert> {<protocol> <start-port>
<end-port> {permit|deny|src-nat [vlan <vlan_id>|tunnel]|dst-nat{<IP-address> <port>|<port>}}
[<option1....option9>]
```

Example

```
(Instant AP) (config)# wlan access-rule employee
(Instant AP) (Access Rule "employee")# rule 10.17.88.59 255.255.255.255 match 6 4343 4343 log
classify-media
(Instant AP) (Access Rule "employee")# rule 192.0.2.8 255.255.255.255 invert 6 110 110 permit
(Instant AP) (Access Rule "employee")# rule 192.0.2.2 255.255.255.0 192.0.2.7 255.255.255.0
match tcp 21 21 deny
(Instant AP) (Access Rule "employee")# rule 192.0.2.2 255.255.255.0 192.0.2.7 255.255.255.0
match udp 21 21 deny
(Instant AP) (Access Rule "employee")# rule 192.0.2.2 255.255.255.0 match 6 631 631 permit
(Instant AP) (Access Rule "employee")# rule 192.0.2.8 255.255.255.255 invert 6 21 21 deny
(Instant AP) (Access Rule "employee")# rule 192.0.2.1 255.255.255.0 invert 17 67 69 deny
```

Configuring NAT Rules

NAT is the process of modifying network address information when packets pass through a routing device. The routing device acts as an agent between the public (the Internet) and the private (local network), which allows translation of private network IP addresses to a public address space.

AOS-W Instant supports the NAT mechanism to allow a routing device to use the translation tables for mapping the private addresses into a single IP address. When packets are sent from this address, they appear to originate from the routing device. Similarly, if packets are sent to the private IP address, the destination address is translated as per the information stored in the translation tables of the routing device.

Configuring a Source-NAT Access Rule

The source-NAT action in access rules allows the user to override the routing profile entries. For example, when a routing profile is configured to use 0.0.0.0/0, the client traffic in L3 mode access on an SSID destined to the corporate network is sent to the tunnel. When an access rule is configured with **Source-NAT** action, the users can specify the service, protocol, or destination to which the source-NAT is applied.

You can also configure source-based routing to allow client traffic on one SSID to reach the Internet through the corporate network, while the other SSID can be used as an alternate uplink. You can create an access rule to perform source-NAT by using the WebUI or the CLI.

In the Old WebUI

To configure a source-NAT access rule:

1. Navigate to the WLAN wizard or the Wired settings window:
 - To configure access rules for a WLAN SSID, in the **Network** tab, click **New** to create a new network profile or click **edit** to modify an existing profile.
 - To configure access rules for a wired profile, **More > Wired**. In the **Wired** window, click **New** under **Wired Networks** to create a new network or click **Edit** to select an existing profile.
2. Click the **Access** tab.
3. To configure access rules for the network, move the slider to the **Network-based** access control type. To configure access rules for user roles, move the slider to the **Role-based** access control type.
4. To create a new rule for the network, click **New**. To create an access rule for a user role, select the user role and then click **New**. The **New Rule** window is displayed.
5. In the **New Rule** window, perform the following steps:
 - a. Select **Access control** from the **Rule type** drop-down list.
 - b. Select **Source-NAT** from the **Action** drop-down list, to allow for making changes to the source IP address.
 - c. Select a service from the list of available services.

Default: All client traffic by default will be directed to the native vlan.
Tunnel: All network-based traffic will be directed to the VPN tunnel.
VLAN: All client based traffic will be directed to the specified uplink VLAN using the IP address of the interface that OAW-IAP has on that VLAN. If the interface is not found, this option has no effect.
 - d. Select the required option from the **Destination** drop-down list.
 - e. If required, enable other parameters such as **Log**, **Blacklist**, **Disable scanning**, **DSCP tag**, and **802.1p priority**.
 - f. Click **OK**.
6. Click **Finish**.

In the New WebUI

To configure a source-NAT access rule:

1. Navigate to the WLAN wizard or the Wired settings window:
 - To configure access rules for a wired or wireless client, go to **Configuration > Networks** page. Click **+** to create a new network or select the network profile to modify an existing profile and click **Edit**.
2. Select the **Access** tab.
3. To configure access rules for the network, select the **Network-based** in the **Access Rules** list box. To configure access rules for user roles, select **Role-based**.
4. To create an access rule for the network, click **+**. To create an access rule for a user role, select the user role in the **Roles** window and then click **+** in the **Access Rules for <network>** window. The **New rule** window is displayed.
5. In the **New rule** window, perform the following steps:
 - a. Select **Access control** from the **Rule type** drop-down list.
 - b. Select **Source-NAT** from the **Action** drop-down list, to allow for making changes to the source IP address.
 - c. Select a Service from the list of available services in the **Network** drop down list box.
Default: All client traffic by default will be directed to the native vlan.
Tunnel: All network-based traffic will be directed to the VPN tunnel.
VLAN: All client based traffic will be directed to the specified uplink VLAN using the IP address of the interface that OAW-IAP has on that VLAN. If the interface is not found, this option has no effect.
 - d. Select the required option from the **Destination** drop-down list.
 - e. If required, enable other parameters such as **Log, Blacklist, Disable scanning, DSCP tag, Time Range** and **802.1p priority**.
 - f. Click **OK**.
6. Click **Finish**.

In the CLI

To configure source-NAT access rule:

```
(Instant AP) (config)# wlan access-rule <access_rule>
(Instant AP) (Access Rule "<access_rule>")# rule <dest> <mask> <match> <protocol> <sport>
<eport> src-nat [vlan <vlan_id>|tunnel]
```

Configuring Policy-Based Corporate Access

To allow different forwarding policies for different SSIDs, you can configure policy-based corporate access. The configuration overrides the routing profile configuration and allows any destination or service to be configured to have direct access to the Internet (bypassing VPN tunnel) based on the ACL rule definition. When policy-based corporate access is enabled, the virtual switch performs source-NAT by using its uplink IP address.

To configure policy-based corporate access:

1. Ensure that an L3 subnet with netmask, gateway, VLAN, and IP address is configured. For more information on configuring L3 subnet, see [Configuring Layer-3 Mobility on page 450](#).
2. Ensure that the source IP address is associated with the IP address configured for the L3 subnet.
3. Create an access rule for the SSID profile with Source-NAT action as described in [Configuring a Source-NAT Access Rule on page 244](#). The source-NAT pool is configured and corporate access entry is created.

Configuring a Destination NAT Access Rule

AOS-W Instant supports configuration of the destination NAT rule, which can be used to redirect traffic to the specified IP address and destination port. The destination NAT configuration is supported only in the bridge mode without VPN.

You can configure a destination NAT access rule by using the WebUI or the CLI.

In the Old WebUI

To configure a destination NAT access rule:

1. Navigate to the WLAN wizard or the Wired settings window:
 - To configure access rules for a WLAN SSID, in the **Network** tab, click **New** to create a new network profile or click **edit** to modify an existing profile.
 - To configure access rules for a wired profile, **More > Wired**. In the **Wired** window, click **New** under **Wired Networks** to create a new network or click **Edit** to select an existing profile.
2. Click the **Access** tab.
3. To configure access rules for the network, move the slider to the **Network-based** access control type. To configure access rules for user roles, move the slider to the **Role-based** access control type.
4. To create a new rule for the network, click **New**. To create an access rule for a user role, select the user role and then click **New**. The **New Rule** window is displayed.
5. In the **New Rule** window, perform the following steps:
 - a. Select **Access control** from the **Rule type** drop-down list.
 - b. Select **destination-NAT** from the **Action** drop-down list, to allow for making changes to the source IP address.
 - c. Specify the IP address and port details.
 - d. Select a service from the list of available services.
 - e. Select the required option from the **Destination** drop-down list.
 - f. If required, enable other parameters such as **Log**, **Blacklist**, **Disable scanning**, **DSCP tag**, and **802.1p priority**.
 - g. Click **OK**.
6. Click **Finish**.

In the New WebUI

To configure a destination NAT access rule:

1. Navigate to the WLAN wizard or the Wired settings window:
 - To configure access rules for a wired or wireless client, go to **Configuration > Networks** tab. Click **+** to create a new network or select the network profile to modify an existing profile and click **Edit**.
2. Select the **Access** tab.
3. To configure access rules for the network, select the **Network-based** in the **Access Rules** list box. To configure access rules for user roles, select **Role-based**.
4. To create an access rule for the network, click **+**. To create an access rule for a user role, select the user role in the **Roles** window and then click **+** in the **Access Rules for <network>** window. The **New rule** window is displayed.
5. In the **New rule** window, perform the following steps:
 - a. Select **Access control** from the **Rule type** drop-down list.
 - b. Select **destination-NAT** from the **Action** drop-down list, to allow for making changes to the source IP address.
 - c. Specify the IP address and port details.

- d. Select a Service from the list of available services in the **Network** drop down list box.
 - e. Select the required option from the **Destination** drop-down list.
 - f. If required, enable other parameters such as **Log, Blacklist, Disable scanning, DSCP tag, Time Range** and **802.1p priority**.
 - g. Click **OK**.
6. Click **Finish**.

In the CLI

To configure destination NAT access rule:

```
(Instant AP) (config)# wlan access-rule <access_rule>
(Instant AP) (Access Rule "<access_rule>")# rule <dest> <mask> <match> <protocol> <sport>
<eport> dst-nat ip <IP-address> [<port>]
```

Configuring ALG Protocols

You can enable or disable protocols for ALG using the WebUI or the CLI.

In the Old WebUI

To enable or disable ALG protocols:

1. Click the **Security** link located directly above the Search bar on the AOS-W Instant main window.
2. Click the **Firewall Settings** tab.
3. Select **Enabled** from the corresponding drop-down lists to enable SIP, VOCERA, Alcatel NOE, and Cisco Skinny protocols.
4. Click **OK**.



When the protocols for ALG are set to **Disabled**, the changes are not applied until the existing user sessions expire. Reboot the OAW-IAP and the client, or wait for a few minutes to view the changes.

In the New WebUI

To enable or disable ALG protocols:

1. Go to **Configuration > Security**.
2. Expand **Firewall Settings**.
3. Under **Application Layer Gateway Algorithms**, the **SIP, VOCERA, Alcatel NOE**, and **Cisco Skinny** protocols are enabled by default. To disable a specific protocol, toggle the corresponding switch to disable.
4. Click **Save**.



When the protocols for ALG are disabled, the changes are not applied until the existing user sessions expire. Reboot the OAW-IAP and the client, or wait for a few minutes to view the changes.

In the CLI

To configure protocols for ALG:

```
(Instant AP) (config)# alg
(Instant AP) (ALG)# sccp-disable
(Instant AP) (ALG)# no sip-disable
(Instant AP) (ALG)# no ua-disable
(Instant AP) (ALG)# no vocera-disable
```

To view the ALG configuration:

```
(Instant AP)# show alg
```

Configuring Firewall Settings for Protection from ARP Attacks

You can configure firewall settings to protect the network against ARP attacks using the WebUI or the CLI.

In the Old WebUI

To configure firewall settings:

1. Click the **Security** link located directly above the search bar on the AOS-W Instant main window.
2. Click the **Firewall Settings** tab. The contents of the **Firewall Settings** tab are displayed.
3. To configure protection against security attacks, select the following check boxes:
 - Select **Enable** from the **Drop bad ARP** drop-down list to enable the OAW-IAP to drop the fake ARP packets.
 - Select **Enable** from the **Fix malformed DHCP** drop-down list to enable the OAW-IAP to fix the malformed DHCP packets.
 - Select **Enable** from the **ARP poison check** drop-down list to enable the OAW-IAP to trigger alerts about ARP poisoning that may have been caused by rogue OAW-IAPs. ARP poisoning detection triggers alerts when a known client on the OAW-IAP spoofs the base MAC address of the OAW-IAP.
4. Click **OK**.

In the New WebUI

To configure firewall settings:

1. Go to **Configuration > Security**.
2. Expand **Firewall Settings**.
3. To configure protection against security attacks, under **Protection against wired attacks** select the following check boxes:
 - Toggle the **Drop bad ARP** switch to enable the OAW-IAP to drop the fake ARP packets.
 - Toggle the **Fix malformed DHCP** switch to enable the OAW-IAP to fix the malformed DHCP packets.
 - Toggle the **ARP poison check** switch to enable the OAW-IAP to trigger alerts about ARP poisoning that may have been caused by rogue OAW-IAPs. ARP poisoning detection triggers alerts when a known client on the OAW-IAP spoofs the base MAC address of the OAW-IAP.
4. Click **Save**.

In the CLI

To configure firewall settings to prevent attacks:

```
(Instant AP) (config)# attack
(Instant AP) (ATTACK)# drop-bad-arp-enable
(Instant AP) (ATTACK)# fix-dhcp-enable
(Instant AP) (ATTACK)# no
(Instant AP) (ATTACK)# poison-check-enable
```

To view the configuration status:

```
(Instant AP)# show attack config
Current Attack
-----
Attack          Status
-----
drop-bad-arp    Enabled
fix-dhcp         Enabled
poison-check     Enabled
```

To view the attack statistics

```
(Instant AP)# show attack stats
```



```

attack counters
-----
Counter                               Value
-----
arp packet counter                    0
drop bad arp packet counter           0
dhcp response packet counter          0
fixed bad dhcp packet counter         0
send arp attack alert counter         0
send dhcp attack alert counter        0
arp poison check counter              0
garp send check counter               0

```

Auto Topology Rules

Auto Topology is a feature that automatically adds ACL rules into the firewall. This ensures that any kind of control-plane messages required for the automatic cluster formation are never blocked. By default, this feature is enabled. However, this feature can be disabled when customers prefer full control on the security policy rather than accepting automatic ACL rules. This feature governs all the ACLs and impacts all the traffic that is hit by the ACLs.

Configuring Firewall Settings to Disable Auto Topology Rules

You can disable the rules by configuring firewall settings in the OAW-IAP.

In order to deny auto topology communication outside the OAW-IAP subnet, the inbound firewall settings must be enabled.

When the inbound firewall settings are enabled:

- ACEs must be configured to block auto topology messages, as there is no default rule at the top of predefined ACLs.
- ACEs must be configured to override the guest VLAN auto-expanded ACEs. In other words, the user defined ACEs take higher precedence over guest VLAN ACEs.

For more information on inbound firewall settings, see [Managing Inbound Traffic on page 250](#)



The priority of a particular ACE is determined based on the order in which it is programmed. Ensure that you do not accidentally override the guest VLAN ACEs.

You can change the status of auto topology rules by using the WebUI or the CLI:

In the Old WebUI

To configure auto topology rules:

1. Click the **Security** located directly above the Search bar in the AOS-W Instant main window.
2. Go to the **Firewall Settings** tab.
3. In **Firewall** section, select **Disabled** from the **Auto topology rules** drop-down list.
4. Click **OK**.

In the New WebUI

To configure auto topology rules:

1. Go to **Configuration > Security**.
2. Expand **Firewall Settings**.
3. Under **Firewall**, The **Auto topology rules** setting is enabled by default. To disable this setting, toggle the switch.

4. Click **Save**.

In the CLI

```
(Instant AP) (config)# firewall  
(Instant AP) (firewall)# disable-auto-topology-rules
```

To view the configuration status:

```
(Instant AP) # show firewall
```

Managing Inbound Traffic

AOS-W Instant now supports an enhanced inbound firewall by allowing the configuration of firewall rules and management subnets, and restricting corporate access through an uplink switch.

To allow flexibility in firewall configuration, AOS-W Instant supports the following features:

- Inbound firewall rules
- Configurable management subnets
- Restricted corporate access

Configuring Inbound Firewall Rules

You can now configure firewall rules for the inbound traffic coming through the uplink ports of an OAW-IAP. The rules defined for the inbound traffic are applied if the destination is not a user connected to the OAW-IAP. If the destination already has a user role assigned, the user role overrides the actions or options specified in the inbound firewall configuration. However, if a deny rule is defined for the inbound traffic, it is applied irrespective of the destination and user role. Unlike the ACL rules in a WLAN SSID or a wired profile, the inbound firewall rules can be configured based on the source subnet.

For all subnets, a deny rule is created by default as the last rule. If at least one rule is configured, the deny all rule is applied to the upstream traffic by default.



Management access to the OAW-IAP is allowed irrespective of the inbound firewall rule. For more information on configuring restricted management access, see [Configuring Management Subnets on page 253](#).

The inbound firewall is not applied to traffic coming through the GRE tunnel.

You can configure inbound firewall rules through the WebUI or the CLI.

In the Old WebUI

1. Navigate to **Security > Inbound Firewall**.
2. Under **Inbound Firewall Rules**, click **New**.
3. Configure the following parameters.

Table 58: Inbound Firewall Rule Configuration Parameters

Parameter	Description
Action	<p>Select any of following actions:</p> <ul style="list-style-type: none"> ■ Select Allow to allow to access users based on the access rule. ■ Select Deny to deny access to users based on the access rule. ■ Select Destination-NAT to allow making changes to the destination IP address and the port. ■ Select Source-NAT to allow making changes to the source IP address. <p>The destination NAT and source NAT actions apply only to the network services rules.</p>
Service	<p>Select a service from the list of available services. You can allow or deny access to any or all of the services based on your requirement:</p> <ul style="list-style-type: none"> ■ any—Access is allowed or denied to all services. ■ custom—Available options are TCP, UDP, and Other. If you select the TCP or UDP options, enter appropriate port numbers. If the Other option is selected, ensure that an appropriate ID is entered.
Source	<p>Select any of the following options:</p> <ul style="list-style-type: none"> ■ from all sources—Traffic from all sources is either allowed, denied, or the IP address is translated at the source or the destination as defined in the rule. ■ from a host—Traffic from a particular host is either allowed, denied, or the IP address is translated at the source or the destination as defined in the rule. After selecting this option, specify the IP address of the host. ■ from a network—Traffic from a particular network is either allowed, denied, or the IP address is translated at the source or the destination as defined in the rule. After selecting this option, specify the IP address and netmask of the source network.
Destination	<p>Select a destination option for the access rules for network services, applications, and application categories. You can allow or deny access to any the following destinations based on your requirements.</p> <ul style="list-style-type: none"> ■ to all destinations—Traffic for all destinations is allowed, denied, or the IP address is translated at the source or the destination as defined in the rule. ■ to a particular server—Traffic to a specific server is allowed, denied, or the IP address is translated at the source or the destination as defined in the rule. After selecting this option, specify the IP address of the destination server. ■ except to a particular server—Access is allowed or denied to servers other than the specified server. After selecting this option, specify the IP address of the destination server. ■ to a network—Traffic to the specified network is allowed, denied, or the IP address is translated at the source or the destination as defined in the rule. After selecting this option, specify the IP address and netmask for the destination network. ■ except to a network—Access is allowed or denied to networks other than the specified network. After selecting this option, specify the IP address and netmask of the destination network. ■ to domain name—Traffic to the specified domain is allowed, denied, or the IP address is translated at the source or the destination as defined in the rule. After selecting this option, specify the domain name in the Domain Name text box.
Log	<p>Select the Log check box if you want a log entry to be created when this rule is triggered. AOS-W Instant supports firewall-based logging function. Firewall logs on the OAW-IAPs are generated as security logs.</p>
Blacklist	<p>Select the Blacklist check box to blacklist the client when this rule is triggered. The blacklisting lasts for the duration specified in the Auth failure blacklist time on the Blacklisting tab of the Security window. For more information, see Blacklisting Clients on page 232.</p>
Disable scanning	<p>Select Disable scanning check box to disable ARM scanning when this rule is triggered.</p>

Table 58: Inbound Firewall Rule Configuration Parameters

Parameter	Description
	The selection of Disable scanning applies only if ARM scanning is enabled. For more information, see Configuring Radio Settings on page 354 .
DSCP tag	Select the DSCP tag check box to specify a DSCP value to prioritize traffic when this rule is triggered. Specify a value within the range of 0–63. To assign a higher priority, specify a higher value.
802.1p priority	Select the 802.1p priority check box to specify an 802.1p priority. Specify a value between 0 and 7. To assign a higher priority, specify a higher value.

4. Click **OK** in the **New Rule** window and then click **OK** in the **Inbound Firewall** tab.

In the New WebUI

1. Navigate to the **Configuration > Security** page.
2. Expand **Inbound Firewall**.
3. Under **Inbound Firewall Rules**, click +.
4. Configure the following parameters.

Table 59: Inbound Firewall Rule Configuration Parameters

Parameter	Description
Action	Select any of following actions: <ul style="list-style-type: none"> ■ Select Allow to allow to access users based on the access rule. ■ Select Deny to deny access to users based on the access rule. ■ Select Destination-NAT to allow making changes to the destination IP address and the port. ■ Select Source-NAT to allow making changes to the source IP address. The destination NAT and source NAT actions apply only to the network services rules.
Service	Select a service from the list of available services. You can allow or deny access to any or all of the services based on your requirement: <ul style="list-style-type: none"> ■ any—Access is allowed or denied to all services. ■ custom—Available options are TCP, UDP, and Other. If you select the TCP or UDP options, enter appropriate port numbers. If the Other option is selected, ensure that an appropriate ID is entered.
Source	Select any of the following options: <ul style="list-style-type: none"> ■ from all sources—Traffic from all sources is either allowed, denied, or the IP address is translated at the source or the destination as defined in the rule. ■ from a host—Traffic from a particular host is either allowed, denied, or the IP address is translated at the source or the destination as defined in the rule. After selecting this option, specify the IP address of the host. ■ from a network—Traffic from a particular network is either allowed, denied, or the IP address is translated at the source or the destination as defined in the rule. After selecting this option, specify the IP address and netmask of the source network.
Destination	Select a destination option for the access rules for network services, applications, and application categories. You can allow or deny access to any the following destinations based on your requirements. <ul style="list-style-type: none"> ■ to all destinations—Traffic for all destinations is allowed, denied, or the IP address is translated at the source or the destination as defined in the rule.

Table 59: Inbound Firewall Rule Configuration Parameters

Parameter	Description
	<ul style="list-style-type: none"> ■ to a particular server—Traffic to a specific server is allowed, denied, or the IP address is translated at the source or the destination as defined in the rule. After selecting this option, specify the IP address of the destination server. ■ except to a particular server—Access is allowed or denied to servers other than the specified server. After selecting this option, specify the IP address of the destination server. ■ to a network—Traffic to the specified network is allowed, denied, or the IP address is translated at the source or the destination as defined in the rule. After selecting this option, specify the IP address and netmask for the destination network. ■ except to a network—Access is allowed or denied to networks other than the specified network. After selecting this option, specify the IP address and netmask of the destination network. ■ to domain name—Traffic to the specified domain is allowed, denied, or the IP address is translated at the source or the destination as defined in the rule. After selecting this option, specify the domain name in the Domain Name text box.
Log	Select the Log check box if you want a log entry to be created when this rule is triggered. AOS-W Instant supports firewall-based logging function. Firewall logs on the OAW-IAPs are generated as security logs.
Blacklist	Select the Blacklist check box to blacklist the client when this rule is triggered. The blacklisting lasts for the duration specified in the Auth failure blacklist time on the Blacklisting tab of the Security window. For more information, see Blacklisting Clients on page 232 .
Disable scanning	Select Disable scanning check box to disable ARM scanning when this rule is triggered. The selection of Disable scanning applies only if ARM scanning is enabled. For more information, see Configuring Radio Settings on page 354 .
DSCP tag	Select the DSCP tag check box to specify a DSCP value to prioritize traffic when this rule is triggered. Specify a value within the range of 0–63. To assign a higher priority, specify a higher value.
802.1p priority	Select the 802.1p priority check box to specify an 802.1p priority. Specify a value between 0 and 7. To assign a higher priority, specify a higher value.

5. Click **OK** in the **New Rule** window and then click **Save**.

In the CLI

To configure inbound firewall rules:

```
(Instant AP) (config)# inbound-firewall
(Instant AP) (inbound-firewall)# rule <subnet> <smask> <dest> <mask> <protocol> <sport> <eport>
{permit|deny|src-nat|dst-nat <IP-address> <port>} [<option1...option9>]
```

Configuring Management Subnets

You can configure subnets to ensure that the OAW-IAP management is carried out only from these subnets. When the management subnets are configured, access through Telnet, SSH, and UI is restricted to these subnets only.

You can configure management subnets by using the WebUI or the CLI.

In the Old WebUI

To configure management subnets:

1. Navigate to the **Security > Inbound Firewall** tab.

2. To add a new management subnet:
 - In the **Add new management subnet** section, enter the subnet address in **Subnet**.
 - Enter the subnet mask in **Mask**.
 - Click **Add**.
3. To add multiple subnets, repeat step 2.
4. Click **OK**.

In the New WebUI

To configure management subnets:

1. Navigate to the **Configuration > Security** page.
2. Expand **Inbound Firewall**.
3. To add a new management subnet:
 - Under **Management Subnets**, click **+**. The **Add new management subnet** window is displayed.
 - Enter the subnet IP address in **Subnet**.
 - Enter the subnet mask in **Mask**.
 - Click **OK**.
4. To add multiple subnets, repeat step 3.
5. Click **Save**.

In the CLI

To configure a management subnet:

```
(Instant AP) (config) # restricted-mgmt-access <subnet-IP-address> <subnet-mask>
```

Configuring Restricted Access to Corporate Network

You can configure restricted corporate access to block unauthorized users from accessing the corporate network. When restricted corporate access is enabled, corporate access is blocked from the uplink port of master OAW-IAP, including clients connected to a slave OAW-IAP. You can configure restricted corporate access by using the WebUI or the CLI.

In the Old WebUI

To configure restricted corporate access:

1. Navigate to the **Security > Inbound Firewall** tab.
2. Select **Enabled** from the **Restrict Corporate Access** drop-down list.
3. Click **OK**.

In the New WebUI

To configure restricted corporate access:

1. Navigate to the **Configuration > Security** page.
2. Expand **Inbound Firewall** tab.
3. Select **Enabled** from the **Restrict Corporate Access** drop-down list.
4. Click **Save**.

In the CLI

To configure restricted management access:

```
(Instant AP) (config) # restrict-corp-access
```

Content Filtering

The content filtering feature allows you to route DNS requests to the OpenDNS platform and create content filtering policies.

With content filter, you can achieve the following:

- Allow all DNS requests to the non-corporate domains on a wireless or wired network to be sent to the OpenDNS server. When the OpenDNS credentials are configured, the OAW-IAP uses these credentials to access OpenDNS and provide enterprise-level content filtering. For more information, see [Configuring OpenDNS Credentials on page 393](#).
- Block certain categories of websites based on your organization policy. For example, if you block the **web-based-email** category, clients who are assigned this policy will not be able to visit email-based websites such as mail.yahoo.com.
- Prevent known malware hosts from accessing your wireless network.
- Improve employee productivity by limiting access to certain websites.
- Reduce bandwidth consumption significantly.



Regardless of whether content filtering is disabled or enabled, the DNS requests to <http://instant.alcatel-lucentnetworks.com> are always resolved internally on AOS-W Instant.

The content filtering configuration applies to all OAW-IAPs in the network and the service is enabled or disabled globally across the wireless or wired network profiles.

Enabling Content Filtering

This section describes the following procedures:

- [Enabling Content Filtering for a Wireless Profile on page 255](#)
- [Enabling Content Filtering for a Wired Profile on page 256](#)

Enabling Content Filtering for a Wireless Profile

To enable content filtering for a wireless SSID, perform the following steps:

In the Old WebUI

Enabling content filtering for a WLAN profile:

1. Select a wireless profile in the **Network** tab and then click the **edit** link. The window for editing the WLAN SSID profile is displayed.
2. Click **Show advanced options**.
3. Under **Miscellaneous**, select **Enabled** from **Content Filtering** drop-down list, and click **Next** to continue.

In the New WebUI

Enabling content filtering for a WLAN profile:

1. Select a wireless profile in the **Configuration > Networks** section and click **Edit**. The window for editing the WLAN SSID profile is displayed.
2. Click **Show advanced options** at the bottom of the window.
3. Under **Miscellaneous**, toggle the **Content filtering** switch to enable.
4. Click **Next** to continue.

You can also enable content filtering while adding a new WLAN profile. For more information, see [Configuring WLAN Settings for an SSID Profile on page 101](#).

In the CLI

To enable content filtering on a WLAN SSID:

```
(Instant AP) (config)# wlan ssid-profile <name>
(Instant AP) (SSID Profile <name>)# content-filtering
```

Enabling Content Filtering for a Wired Profile

To enable content filtering for a wired profile, perform the following steps:

In the Old WebUI

Enabling content filtering for a wired profile:

1. Click the **Wired** link under **More** in the AOS-W Instant main window. The **Wired** window is displayed.
2. In the **Wired** window, select the wired profile to modify.
3. Click **Edit**. The **Edit Wired Network** window is displayed.
4. In the **Wired Settings** tab, select **Enabled** from the **Content Filtering** drop-down list, and click **Next** to continue.

In the New WebUI

Enabling content filtering for a wired profile:

1. Select a wired profile in the **Configuration > Networks** section and click **Edit**. The window for editing the wired profile is displayed.
2. Click **Show advanced options** at the bottom of the window.
3. Under **Miscellaneous**, toggle the **Content filtering** switch to enable.
4. Click **Next** to continue.

In the CLI

To enable content filtering for a wired profile in the CLI:

```
(Instant AP) (config)# wired-port-profile test
(Instant AP) (wired ap profile <name>)# content-filtering
```

Configuring Enterprise Domains

The enterprise domain names list displays the DNS domain names that are valid on the enterprise network. This list is used to determine how client DNS requests must be routed. When **Content Filtering** is enabled, the DNS request of the clients is verified and the domain names that do not match the names in the list are sent to the OpenDNS server.

You can configure an enterprise domain through the WebUI or the CLI.

In the Old WebUI

To manually add a domain:

1. Click the **Tunnelling** link under **More** in the AOS-W Instant main window.
2. In the **Tunnelling** window, select **Enterprise Domains**.
3. Click **New** and enter a new domain name.
4. Click **OK**.
5. Click **Finish**.

To delete a domain, select the domain and click **Delete**. This will remove the domain name from the list.

In the New WebUI

To manually add a domain:

1. Go to **Configuration > Tunnelling** .
2. Expand **Enterprise Domains**.
3. Click **+** and enter a new domain name.
4. Click **OK** .
5. Click **Save**.

To delete a domain, select the domain and delete. This will remove the domain name from the list.

In the CLI

To configure an enterprise domain:

```
(Instant AP) (config)# internal-domains
(Instant AP) (domain)# domain-name <name>
```

Configuring URL Filtering Policies

You can configure URL filtering policies to block certain categories of websites based on your organization specifications by defining ACL rules either through the WebUI or the CLI.

In the Old WebUI

To control access based on web categories and security settings:

1. Navigate to **Security > Roles**.
2. In the **Roles** window, select any WLAN SSID or wired profile role, and click **New** in the **Access Rules for <network>** section. The **New Rule** window is displayed.
3. Select **Access Control** from the **Rule Type** drop-down list.
4. To set an access policy based on the web category:
 - a. Under **Service** section, select **Web category** and expand the drop-down list that contains the web categories.
 - b. Select the categories to which you want to deny or allow access. You can also search for a web category and select the required option.
 - c. From the **Action** drop-down list, select **Allow** or **Deny** as required.
 - d. Click **OK**.
5. To filter access based on the security ratings of the website:
 - a. Select **Web reputation** under **Service** section.
 - b. Move the slider to the required security rating level.
 - c. From the **Action** drop-down list, select **Allow** or **Deny** as required.
6. To set a bandwidth limit based on web category or web reputation score, select the **Application Throttling** check box and specify the downstream and upstream rates in Kbps. For example, you can set a higher bandwidth for trusted sites and a low bandwidth rate for high-risk sites.
7. Click **OK** to save the rules.
8. Click **OK** in the **Roles** tab to save the changes to the role for which you defined ACL rules.

In the New WebUI

To control access based on web categories and security settings:

1. Navigate to **Configuration > Security**.
2. Expand **Roles**.

3. In the **Roles** window, select any WLAN SSID or wired profile role, and click **+** in the **Access Rules for <network>** section. The **New rule** window is displayed.
4. Select **Access Control** from the **Rule type** drop-down list.
5. To set an access policy based on the web category:
 - a. Under **Service** section, select **Web category** and expand the drop-down list that contains the web categories.
 - b. Select the categories to which you want to deny or allow access. You can also search for a web category and select the required option.
 - c. From the **Action** drop-down list, select **Allow** or **Deny** as required.
6. To filter access based on the security ratings of the website:
 - a. Select **Web reputation** under **Service**.
 - b. Move the slider to the required security rating level.
 - c. From the **Action** drop-down list, select **Allow** or **Deny** as required.
7. To set a bandwidth limit based on web category or web reputation score, select the **Application Throttling** check box and specify the downstream and upstream rates in Kbps. For example, you can set a higher bandwidth for trusted sites and a low bandwidth rate for high-risk sites.
8. Click **OK** to save the rules.
9. Click **Save** to save the changes to the role for which you defined ACL rules.

In the CLI

To control access based on web categories and security ratings:

```
(Instant AP) (config)# wlan access-rule <access_rule>
(Instant AP) (Access Rule "<access-rule>")# rule <dest> <mask> <match> webcategory <webgrp>
{permit| deny} [<option1...option9>]
(Instant AP) (Access Rule "<access-rule>")# rule <dest> <mask> <match> webreputation <webrep>
{permit|deny} [<option1...option9>]
```

Creating Custom Error Page for Web Access Blocked by AppRF Policies

You can create a list of URLs to which the users are redirected when they access blocked websites. You can define an access rule to use these redirect URLs and assign the rule to a user role in the WLAN network.

Creating a List of Error Page URLs

You can create a list of custom URLs and ACL rules for blocked websites either through the WebUI or the CLI.

In the Old WebUI

To create a list of error page URLs:

1. Navigate to **Security > Custom Blocked Page URL**.
2. Click **New** and enter the URL that you want to block.
3. Repeat the procedure to add more URLs. You can add up to 8 URLs to the blocked page list.
4. Click **OK** in the **URL** window.
5. Click **OK** in the **Custom Blocked Page URL** tab.

In the New WebUI

To create a list of error page URLs:

1. Navigate to **Configuration > Security > Custom Blocked Page URL**.
2. Click **+** and enter the URL that you want to block.
3. Repeat the procedure to add more URLs. You can add up to 8 URLs to the blocked page list.

4. Click **OK** in the **URL** window.
5. Click **Save**.

In the CLI

To create a list of error page URLs:

```
(Instant AP) (config)# dpi-error-page-url <idx> <url>
```

Configuring ACL Rules to Redirect Blocked HTTP Websites to a Custom Error Page URL

To redirect blocked HTTP websites to a custom error page URL:

In the Old WebUI

1. Navigate to **Security > Roles**.
2. In the **Roles** window, select any WLAN SSID or Wired profile role, and click **New** in the **Access Rules for <network>** section.
3. In the **New Rule** window, select the rule type as **Redirect Page URL**.
4. Select the URLs from the existing list of custom redirect URLs. To add a new URL, click **New**, add the URL, and click **OK** in the **URL** window.
5. Click **OK** in the **Roles** tab to save the changes.

In the New WebUI

1. Navigate to **Configuration > Security > Roles**.
2. In the **Roles** window, select any WLAN SSID or Wired profile role, and click **+** in the **Access Rules for <network>** section.
3. In the **New rule** window, select the rule type as **Redirect Page URL**.
4. Select the URLs from the existing list of custom redirect URLs and click **OK**.
5. Click **Save**.

In the CLI

To configure an ACL rule to redirect blocked HTTP websites to a custom error page URL:

```
(Instant AP) (config)# wlan access-rule <access_rule_name>  
(Instant AP) (Access Rule "<access_rule_name>")# dpi-error-page-url <idx>
```

Configuring ACL Rules to Redirect Blocked HTTPS Websites to a Custom Blocked Page URL

Before you configure an ACL rule for a specific WLAN SSID or Wired profile to redirect HTTPS websites to a custom error page, you must ensure that the Blocked Page URL rule is configured for the HTTP websites blocked for the same WLAN SSID or Wired profile. In this scenario, all the blocked HTTP and HTTPS websites will be redirected to the custom error page URL.



To redirect blocked HTTPS websites to a custom error page URL

In the Old WebUI

1. Navigate to **Security > Roles**.
2. Select any WLAN SSID or Wired profile role, and click **New** in the **Access Rules for <network>** section.
3. In the **New Rule** window, select the rule type as **Redirect Blocked HTTPS**.
4. Click **OK** in the **New Rule** window.
5. Click **OK** in the **Roles** tab to save the changes.

In the New WebUI

1. Navigate to **Configuration > Security > Roles**.
2. Select any WLAN SSID or Wired profile role, and click + in the **Access Rules for <network>** section.
3. In the **New Rule** window, select the rule type as **Redirect Blocked HTTPS**.
4. Click **OK** in the **New rule** window..
5. Click **Save**.

In the CLI

To configure an ACL rule to redirect blocked HTTPS to a custom error page URL:

```
(Instant AP) (config)# wlan access-rule <access_rule_name>
(Instant AP) (Access Rule "<access_rule_name>")# dpi-error-page-url <idx>
(Instant AP) (Access Rule "<access_rule_name>")# redirect-blocked-https-traffic
```

Configuring User Roles

Every client in the AOS-W Instant network is associated with a user role that determines the network privileges for a client, the frequency of reauthentication, and the applicable bandwidth contracts.



AOS-W Instant allows you to configure up to 32 user roles. If the number of roles exceed 32, an error message is displayed.

The user role configuration on an OAW-IAP involves the following procedures:

- [Creating a User Role on page 260](#)
- [Assigning Bandwidth Contracts to User Roles on page 261](#)
- [Configuring Machine and User Authentication Roles on page 262](#)
- [Configuring Downloadable User Roles \(DUR\) on page 263](#)
- [ClearPass Policy Manager Certificate Validation for Downloadable User Roles \(DUR\) on page 264](#)

Creating a User Role

You can create a user role by using the WebUI or the CLI.

In the Old WebUI

To create a user role:

1. Click the **Security** link located directly above the Search bar in the AOS-W Instant main window. The **Security** window is displayed.
2. Click the **Roles** tab. The Roles tab contents are displayed.
3. Under Roles, click **New**.
4. Enter a name for the new role and click **OK**.
5. Click **OK** in the **Roles** tab to save the changes.

In the New WebUI

To create a user role:

1. Go to **Configuration > Security**.
2. Click the **Roles** tab. The **Roles** tab contents are displayed.
3. Under **Roles**, click +.
4. Enter a name for the new role and click **OK**.

5. Click **Save** in the **Roles** tab.



You can also create a user role when configuring wireless or wired network profiles. For more information, see [Configuring Access Rules for a WLAN SSID Profile on page 121](#) and [Configuring Access Rules for a Wired Profile on page 140](#).

In the CLI

To configure user roles and access rules:

```
(Instant AP) (config)# wlan access-rule <access-rule-name>
(Instant AP) (Access Rule <Name>)# rule <dest> <mask> <match> <protocol> <start-port> <end-
port> {permit|deny|src-nat [vlan <vlan_id>|tunnel]|dst-nat {<IP-address> <port>|<port>}}
[<option1...option9>]
```

Assigning Bandwidth Contracts to User Roles

The administrators can manage bandwidth utilization by assigning either maximum bandwidth rates, or bandwidth contracts to user roles. The administrator can assign a bandwidth contract configured in Kbps to upstream (client to the OAW-IAP) or downstream (OAW-IAP to clients) traffic for a user role.

By default, all users that belong to the same role share a configured bandwidth rate for upstream or downstream traffic. The assigned bandwidth will be served and shared among all the users. You can also assign bandwidth rate per user to provide every user a specific bandwidth within a range of 1–65,535 Kbps. If there is no bandwidth contract specified for a traffic direction, unlimited bandwidth is allowed.



In the earlier releases, bandwidth contract could be assigned per SSID. In the current release, the bandwidth contract can also be assigned for each SSID user. If the bandwidth contract is assigned for an SSID in the AOS-W Instant 6.2.1.0-3.4.0.0 version, and when the OAW-IAP is upgraded to a later release version, the bandwidth configuration per SSID will be treated as a per-user downstream bandwidth contract for that SSID.

The bandwidth contract for a user role can be applied to an OAW-IAP or to a cluster.

Example

In a cluster of 5 OAW-IAPs with an upstream WAN limit of 100 Mbps, you must set the WAN limit to 20 Mbps for each OAW-IAP, in order to meet the requirement of maintaining the WAN limit of 100 Mbps. However, clients cannot exceed 20 Mbps when needed, even if the cluster output is less than 100 Mbps.

If you want to add more OAW-IAPs, you must re-calculate the WAN limit and manually apply it. It is recommended that you apply the WAN limit at cluster level as it is more flexible. Also, there is no need to manually re-calculate the WAN limit if additional OAW-IAPs are added or removed, in order to meet the upstream WAN constraints.

In the Old WebUI

1. Click the **Security** link located directly above the Search bar in the AOS-W Instant main window. The **Security** window is displayed.
2. Click the **Roles** tab. The **Roles** tab contents are displayed.
3. Create a new role (see [Creating a User Role on page 260](#)) or select an existing role.
4. Under **Access Rules**, click **New**. The **New Rule** window is displayed.
5. Select **Bandwidth Contract** from the **Rule type** drop-down list.
6. Specify the downstream and upstream rates in Kbps. If the assignment is specific for each user, select the **Per user** check box.
7. Click **OK**.
8. Click **OK** in the **Roles** tab to save the changes.

9. Associate the user role to a WLAN SSID or a wired profile.
10. To associate the user role to a WLAN SSID or a wired profile, navigate to the WLAN wizard or Wired window.
 - Go to the **Access** tab. Move the slider to **Role-based** in the **Access Rules** section.
 - Under **Role Assignment Rules**, click **New**.
 - Select the user role from the **Role** drop-down list and then click **OK**.
 - Click **Next** and then click **Finish**.

In the New WebUI

1. Go to **Configuration** > **Security**.
2. Expand **Roles** tab.
3. Create a new role (see [Creating a User Role on page 260](#)) or select an existing role.
4. Under **Access Rules**, click +. The **New rule** window is displayed.
5. Select **Bandwidth Contract** from the **Rule type** drop-down list.
6. Specify the downstream and upstream rates in Kbps. If the assignment is specific for each user, select the **Per user** check box.
7. Click **OK**.
8. Click **Save**.
9. To associate the user role to a WLAN SSID or a wired profile, navigate to the WLAN wizard or Wired window.
 - Go to **Configuration** > **Networks** and select a network profile to modify and click **Edit**.
 - Select **Access** tab. Select **Role-based** in the **Access Rules** drop-down list.
 - Under **Role Assignment Rules**, click +.
 - Select the user role from the **Role** drop-down list and then click **OK**.
 - Click **Finish**.

In the CLI:

To assign a bandwidth contract in the CLI:

```
(Instant AP) (config)# wlan access-rule <name>
(Instant AP) (Access Rule <name>)# bandwidth-limit {downstream <kbps>|upstream <kbps>|peruser
{downstream <kbps>| upstream <kbps>}}
```

To associate the access rule to a wired profile:

```
(Instant AP) (config)# wired-port-profile <name>
(Instant AP) (wired ap profile <name>)# access-rule-name <access-rule-name>
```

Configuring Machine and User Authentication Roles

You can assign different rights to clients based on whether their hardware device supports machine authentication. Machine authentication is only supported on Windows devices, so that this can be used to distinguish between Windows devices and other devices such as iPads.

You can create any of the following types of rules:

- **Machine Auth only** role—This indicates a Windows machine with no user logged in. The device supports machine authentication and has a valid RADIUS account, but a user has not yet logged in and authenticated.
- **User Auth only** role—This indicates a known user or a non-Windows device. The device does not support machine authentication or does not have a RADIUS account, but the user is logged in and authenticated.

When a device does both machine and user authentication, the user obtains the default role or the derived role based on the RADIUS attribute.

You can configure machine authentication with role-based access control using the WebUI or the CLI.

In the Old WebUI

To configure machine authentication with role-based access control:

1. In the **Access** tab of the WLAN wizard (**New WLAN** or **Edit <WLAN-profile>**) or in the wired profile configuration window (**New Wired Network** or **Edit Wired Network**), click the **Enforce Machine Authentication** check box.
2. Configure access rules for these roles by selecting the roles in the **Machine auth only** and **User auth only** drop-down lists. For more information on configuring access rules, see [Configuring ACL Rules for Network Services on page 240](#).
3. Select **Enforce Machine Authentication** and select the **Machine auth only** and **User auth only** roles.
4. Click **Finish** to apply these changes.

In the New WebUI

To configure machine authentication with role-based access control:

1. Go to **Configuration > Networks**. To modify an existing network profile, select the profile and click **Edit**. To create a new network, click **+**.
2. Select the **Access** tab.
3. Select **Role-based** from the **Access Rules** drop-down list.
4. Toggle the **Enforce Machine Authentication** switch to enable.
5. Configure access rules for these roles by selecting the roles in the **Machine auth only** and **User auth only** drop-down lists. For more information on configuring access rules, see [Configuring ACL Rules for Network Services on page 240](#).
6. Click **Next** and then click **Finish** to apply these changes.

In the CLI

To configure machine and user authentication roles for a WLAN SSID:

```
(Instant AP) (config)# wlan ssid-profile <name>
(Instant AP) (SSID Profile <name>)# set-role-machine-auth <machine_only> <user_only>
```

To configure machine and user authentication roles for a wired profile:

```
(Instant AP) (config)# wired-port-profile <name>
(Instant AP) (wired ap profile <name>)# set-role-machine-auth <machine_only> <user_only>
```

Configuring Downloadable User Roles (DUR)

Alcatel-Lucent AOS-W Instant and ClearPass Policy Manager include support for centralized policy definition and distribution. Alcatel-Lucent AOS-W Instant now supports downloadable user roles. When ClearPass Policy Manager successfully authenticates a user, the user is assigned a role by ClearPass Policy Manager. If the role is not defined on the OAW-IAP, the role attributes can also be downloaded automatically.

In order to provide highly granular per-user level access, user roles can be created when a user has been successfully authenticated. During the configuration of a policy enforcement profile in ClearPass Policy Manager, the administrator can define a role that should be assigned to the user after successful authentication. In RADIUS authentication, when ClearPass Policy Manager successfully authenticates a user, the user is assigned a role by ClearPass Policy Manager. If the role is not defined on the OAW-IAP, the role

attributes can also be downloaded automatically. This feature supports roles obtained by the following authentication methods:

- 802.1X (WLAN and wired users)
- MAC authentication
- Captive Portal

In the CLI

You can enable role download using the AOS-W Instant CLI:

```
(Instant AP) (config)# wlan ssid-profile <profile_name>
(Instant AP) (SSID Profile <profile_name>)# download-role
(Instant AP) (SSID Profile <profile_name>)# end
(Instant AP)# commit apply
```

To configure a ClearPass Policy Manager username and password for RADIUS authentication:

```
(Instant AP) (config)# wlan auth-server <profile_name>
(Instant AP) (Auth Server <profile_name>)# cppm {username <username> password <password>}
(Instant AP) (Auth Server <profile_name>)# end
(Instant AP)# commit apply
```

Execute the following command to check if role download is enabled on the network profile:

```
(Instant AP)# show network <profile_name>
```

ClearPass Policy Manager Certificate Validation for Downloadable User Roles (DUR)

When a ClearPass Policy Manager server is configured as the domain for RADIUS authentication for downloading user roles, in order to validate the ClearPass Policy Manager customized CA, OAW-IAPs are required to publish the root CA for the HTTPS server to the well-known URI (**<http://<clearpass-fqdn>/well-known/aruba/clearpass/https-root.pem>**). The OAW-IAP must ensure that an FQDN is defined in the above URI for the RADIUS server and then attempt to fetch the trust anchor by using the RADIUS FQDN.

Upon configuring the domain of the ClearPass Policy Manager server for RADIUS authentication along with a username and password, the OAW-IAP tries to retrieve the CA from the above well-known URI and store it in flash memory. However, if there is more than one ClearPass Policy Manager server configured for authentication, the CA must be uploaded manually.

In the CLI:

To retrieve the CA from the ClearPass Policy Manager FQDN:

```
(Instant AP)# download-cert clearpassca <url> format pem
```

To copy the ClearPass Policy Manager CA from the TFTP server to the OAW-IAP:

```
(Instant AP)# copy tftp <addr> <file> clearpassca format pem
```

To clear the ClearPass Policy Manager CA from the OAW-IAP:

```
(Instant AP)# clear-cert clearpassca
```

To view the current ClearPass Policy Manager CA uploaded on the OAW-IAP:

```
(Instant AP)# show clearpassca
```

To view the ClearPass Policy Manager CA count in the AP checksum:

```
(Instant AP)# show ap checksum
```

Configuring Derivation Rules

AOS-W Instant allows you to configure role and VLAN derivation-rules. You can configure these rules to assign a user role or a VLAN to the clients connecting to an SSID or a wired profile.

Understanding Role Assignment Rule

When an SSID or a wired profile is created, a default role for the clients connecting to this SSID or wired profile is assigned. You can assign a user role to the clients connecting to an SSID by any of the following methods. The role assigned by some methods may take precedence over the roles assigned by the other methods.

RADIUS VSA Attributes

The user role can be derived from Alcatel-Lucent VSA for RADIUS server authentication. The role derived from an Alcatel-Lucent VSA takes precedence over roles defined by other methods.

MAC-Address Attribute

The first three octets in a MAC address are known as OUI, and are purchased from the IEEE, Incorporated RA. This identifier uniquely identifies a vendor, manufacturer, or other organization (referred to by the IEEE as the “assignee”) globally and effectively reserves a block of each possible type of derivative identifier (such as MAC addresses) for the exclusive use of the assignee.

OAW-IAPs use the OUI part of a MAC address to identify the device manufacturer and can be configured to assign a desired role for users who have completed 802.1X authentication and MAC authentication. The user role can be derived from the user attributes after a client associates with an OAW-IAP. You can configure rules to assign a user role to clients that match a MAC-address-based criteria. For example, you can assign a voice role to any client with a MAC address starting with a0:a1:a2.

Roles Based on Client Authentication

The user role can be the default user role configured for an authentication method, such as 802.1X authentication. For each authentication method, you can configure a default role for the clients who are successfully authenticated using that method.

Understanding Device Identification

The device identification feature allows you to assign a user role or VLAN to a specific device type by identifying a DHCP option and signature for that device. If you create a user role with the **DHCP-Option** rule type, the first two characters in the attribute value must represent the hexadecimal value of the DHCP option that this rule should match with, while the rest of the characters in the attribute value indicate the DHCP signature the rule should match with. To create a rule that matches DHCP option 12 (host name), the first two characters of the in the attribute value must be the hexadecimal value of 12, which is 0C. To create a rule that matches DHCP option 55, the first two characters in the attribute value must be the hexadecimal value of 55, which is 37.

The following table describes some of the DHCP options that are useful for assigning a user role or VLAN:

Table 60: DHCP Option Values

DHCP Option	Description	Decimal Value	Hexadecimal Value
Hostname	The name of the client device.	12	0C
Parameter Request List	The configuration values requested by the client.	55	37
Vendor Class Identifier	Vendors use the option to convey configuration information about the client to the Server.	60	3C

DHCP Option	Description	Decimal Value	Hexadecimal Value
Client Identifier	Clients use this option to uniquely identify themselves and value corresponds to the MAC address of client.	61	3D
Client FQDN	The FQDN name of the client with the domain name.	81	51

DHCP Option and DHCP Fingerprinting

The DHCP fingerprinting allows you to identify the operating system of a device by looking at the options in the DHCP frame. Based on the operating system type, a role can be assigned to the device.

For example, to create a role assignment rule with the DHCP option, select **equals** from the **Operator** drop-down list and enter 370103060F77FC in the **String** text box. Since 370103060F77FC is the fingerprint for Apple iOS devices such as iPad and iPhone, OAW-IAP assigns Apple iOS devices to the role that you choose.

Table 61: Validated DHCP Fingerprint

Device	DHCP Option	DHCP Fingerprint
Apple iOS	Option 55	370103060F77FC
Android	Option 60	3C64686370636420342E302E3135
Blackberry	Option 60	3C426C61636B4265727279
Windows 7/Vista Desktop	Option 55	37010f03062c2e2f1f2179f92b
Windows XP (SP3, Home, Professional)	Option 55	37010f03062c2e2f1f21f92b
Windows Mobile	Option 60	3c4d6963726f736f66742057696e646f777320434500
Windows 7 Phone	Option 55	370103060f2c2e2f
Apple Mac OS X	Option 55	370103060f775ffc2c2e2f

Creating a Role Derivation Rule

You can configure rules for determining the role that is assigned for each authenticated client.



When creating more than one role assignment rule, the first matching rule in the rule list is applied.

You can create a role assignment rule by using the WebUI or the CLI.

In the Old WebUI

- Navigate to the WLAN wizard or the Wired settings window:
 - To configure access rules for a WLAN SSID, in the **Network** tab, click **New** to create a new network profile or **edit** to modify an existing profile.
 - To configure access rules for a wired profile, go to **More > Wired**. In the **Wired** window, click **New** under **Wired Networks** to create a new network or click **Edit** to select an existing profile.
- Click the **Access** tab.

3. Under **Role Assignment Rules**, click **New**. The **New Role Assignment** window allows you to define a match method by which the string in *Operand* is matched with the attribute value returned by the authentication server.
4. Select the attribute that matches with the rule from the **Attribute** drop-down list. The list of supported attributes includes RADIUS attributes, dhcp-option, dot1x-authentication-type, mac-address, and mac-address-and-dhcp-options. For information on a list of RADIUS attributes, see [RADIUS Server Authentication with VSA on page 194](#).
5. Select the operator from the **Operator** drop-down list. The following types of operators are supported:
 - **contains**—The rule is applied only if the attribute value contains the string specified in *Operand*.
 - **Is the role**—The rule is applied if the attribute value is the role.
 - **equals**—The rule is applied only if the attribute value is equal to the string specified in *Operand*.
 - **not-equals**—The rule is applied only if the attribute value is not equal to the string specified in *Operand*.
 - **starts-with**—The rule is applied only if the attribute value starts with the string specified in *Operand*.
 - **ends-with**—The rule is applied only if the attribute value ends with the string specified in *Operand*.
 - **matches-regular-expression**—The rule is applied only if the attribute value matches the Regex pattern specified in *Operand*. This operator is available only if the **mac-address-and-dhcp-options** attribute is selected in the **Attribute** drop-down list. The **mac-address-and-dhcp-options** attribute and **matches-regular-expression** are applicable only for the WLAN clients.
6. Enter the string to match the attribute in the **String** text box.
7. Select the appropriate role from the **Role** drop-down list.
8. Click **OK**.
9. Click **Finish**.

In the New WebUI

1. Navigate to the WLAN wizard or the Wired settings window:
 - Go to **Configuration > Networks**. To modify an existing network profile, select the profile and click **Edit**. To create a new network, click **+**.
2. Select the **Access** tab.
3. Select **Role-based** in the **Access Rules** drop-down list.
4. Under **Role Assignment Rules**, click **+**. The **New Role Assignment** window allows you to define a match method by which the string in *Operand* is matched with the attribute value returned by the authentication server.
5. Select the attribute that matches with the rule from the **Attribute** drop-down list. The list of supported attributes includes RADIUS attributes, dhcp-option, dot1x-authentication-type, mac-address, and mac-address-and-dhcp-options. For more information on a list of RADIUS attributes, see [RADIUS Server Authentication with VSA on page 194](#).
6. Select the operator from the **Operator** drop-down list. The following types of operators are supported:
 - **contains**—The rule is applied only if the attribute value contains the string specified in *Operand*.
 - **Is the role**—The rule is applied if the attribute value is the role.
 - **equals**—The rule is applied only if the attribute value is equal to the string specified in *Operand*.
 - **not-equals**—The rule is applied only if the attribute value is not equal to the string specified in *Operand*.
 - **starts-with**—The rule is applied only if the attribute value starts with the string specified in *Operand*.
 - **ends-with**—The rule is applied only if the attribute value ends with the string specified in *Operand*.
 - **matches-regular-expression**—The rule is applied only if the attribute value matches the Regex pattern specified in *Operand*. This operator is available only if the **mac-address-and-dhcp-options**

attribute is selected in the **Attribute** drop-down list. The **mac-address-and-dhcp-options** attribute and **matches-regular-expression** are applicable only for the WLAN clients.

7. Enter the string to match the attribute in the **String** text box.
8. Select the appropriate role from the **Role** drop-down list.
9. Click **OK**.
10. Click **Finish**.

When **Enforce Machine Authentication** is enabled, both the device and the user must be authenticated for the role assignment rule to apply.



Each device type may not have a unique DHCP fingerprint signature. For example, devices from different manufacturers may use vendor class identifiers that begin with similar strings. If you create a DHCPOption rule that uses the **starts-with** condition instead of the **equals** condition, the rule may assign a role or VLAN to more than one device type.

In the CLI

To configure role assignment rules for a WLAN SSID:

```
(Instant AP) (config)# wlan ssid-profile <name>
(Instant AP) (SSID Profile <name>)# set-role <attribute>{{equals|not-equals|starts-with|ends-with|contains|matches-regular-expression} <operator><role>|value-of}
```

To configure role assignment rules for a wired profile:

```
(Instant AP) (config)# wired-port-profile <name>
(Instant AP) (wired ap profile <name>)# set-role <attribute>{{equals|not-equal|starts-with|ends-with|contains}<operator> <role>|value-of}
```

Example

```
(Instant AP) (config)# wlan ssid-profile Profile1
(Instant AP) (SSID Profile "Profile1")# set-role mac-address-and-dhcp-options matches-regular-expression \bring\b Profile1
```

Understanding VLAN Assignment

You can assign VLANs to a client based on the following configuration conditions:

- The default VLAN configured for the WLAN can be assigned to a client.
- If VLANs are configured for a WLAN SSID or an Ethernet port profile, the VLAN for the client can be derived before the authentication, from the rules configured for these profiles.
- If a rule derives a specific VLAN, it is prioritized over the user roles that may have a VLAN configured.
- The user VLANs can be derived from the default roles configured for 802.1X authentication or MAC authentication.
- After client authentication, the VLAN can be derived from VSA for RADIUS server authentication.
- The DHCP-based VLANs can be derived for captive portal authentication.
- After client authentication, the VLAN can be derived from Microsoft Tunnel attributes (Tunnel-Type, Tunnel Medium Type, and Tunnel Private Group ID). All three attributes must be present as shown below. This does not require a server-derived rule. For example:

```
Tunnel-Type="VLAN" (13)
Tunnel-Medium-Type="IEEE-802" (6)
Tunnel-Private-Group-Id="101"
```



AOS-W Instant supports role derivation based on the DHCP option for captive portal authentication. When the captive portal authentication is successful, the role derivation based on the DHCP option assigns a new user role to the guest users, instead of the pre-authenticated role.

VSA

When an external RADIUS server is used, the user VLAN can be derived from the **Alcatel-Lucent-User-Vlan** VSA. The VSA is then carried in an *Access-Accept* packet from the RADIUS server. The OAW-IAP can analyze the return message and derive the value of the VLAN which it assigns to the user.

Figure 5 RADIUS Access-Accept Packets with VSA

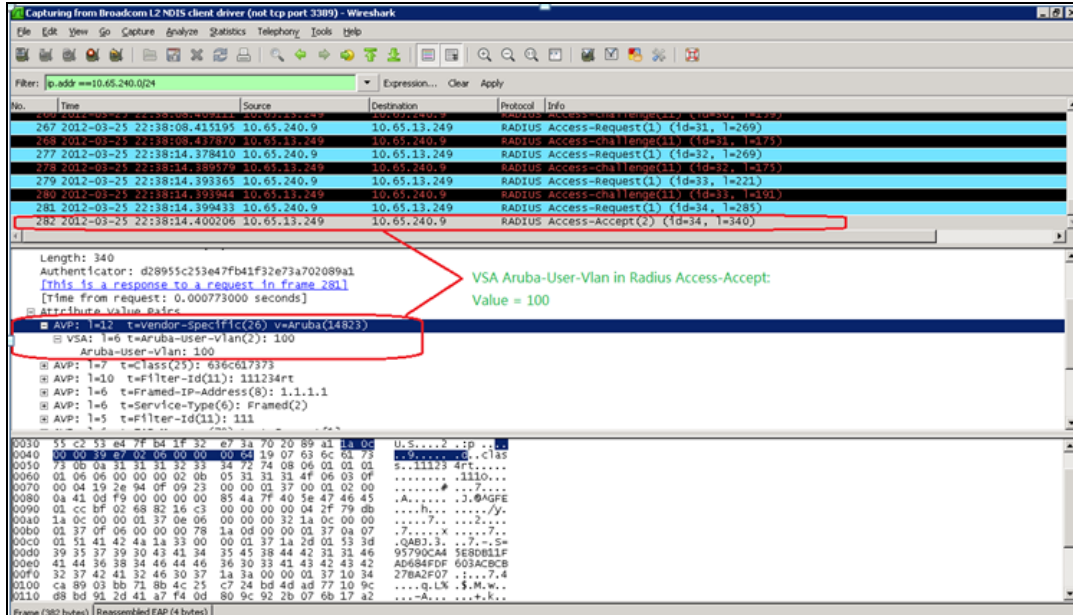
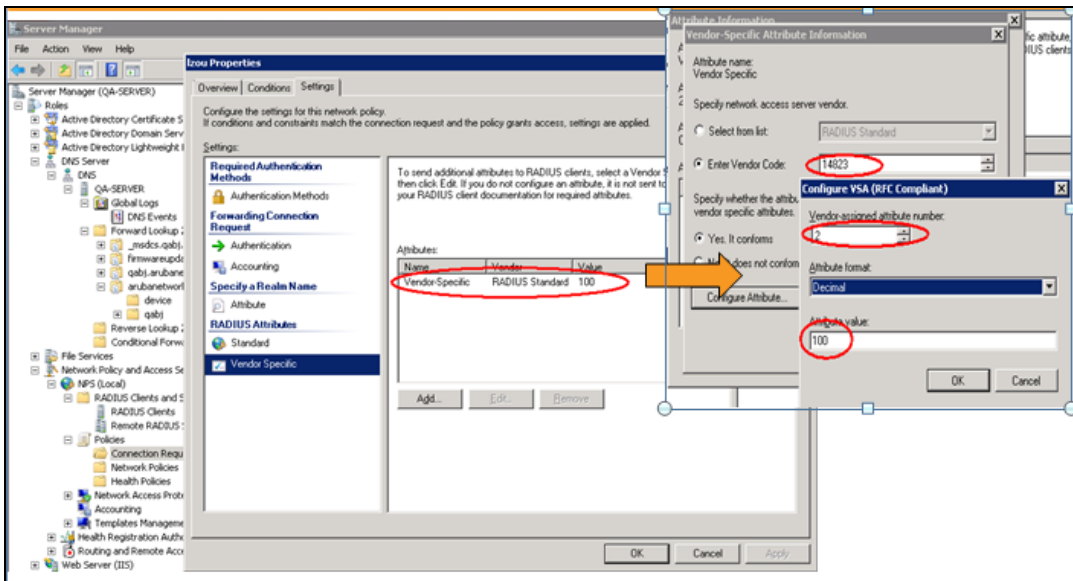

Figure 6 Configure VSA on a RADIUS Server



VLAN Assignment Based on Derivation Rules

When an external RADIUS server is used for authentication, the RADIUS server may return a reply message for authentication. If the RADIUS server supports return attributes, and sets an attribute value to the reply message, the OAW-IAP can analyze the return message and match attributes with a user pre-defined VLAN derivation rule. If the rule is matched, the VLAN value defined by the rule is assigned to the user. For a complete list of RADIUS server attributes, see [RADIUS Server Authentication with VSA on page 194](#).

Figure 7 Configuring RADIUS Attributes on the RADIUS Server

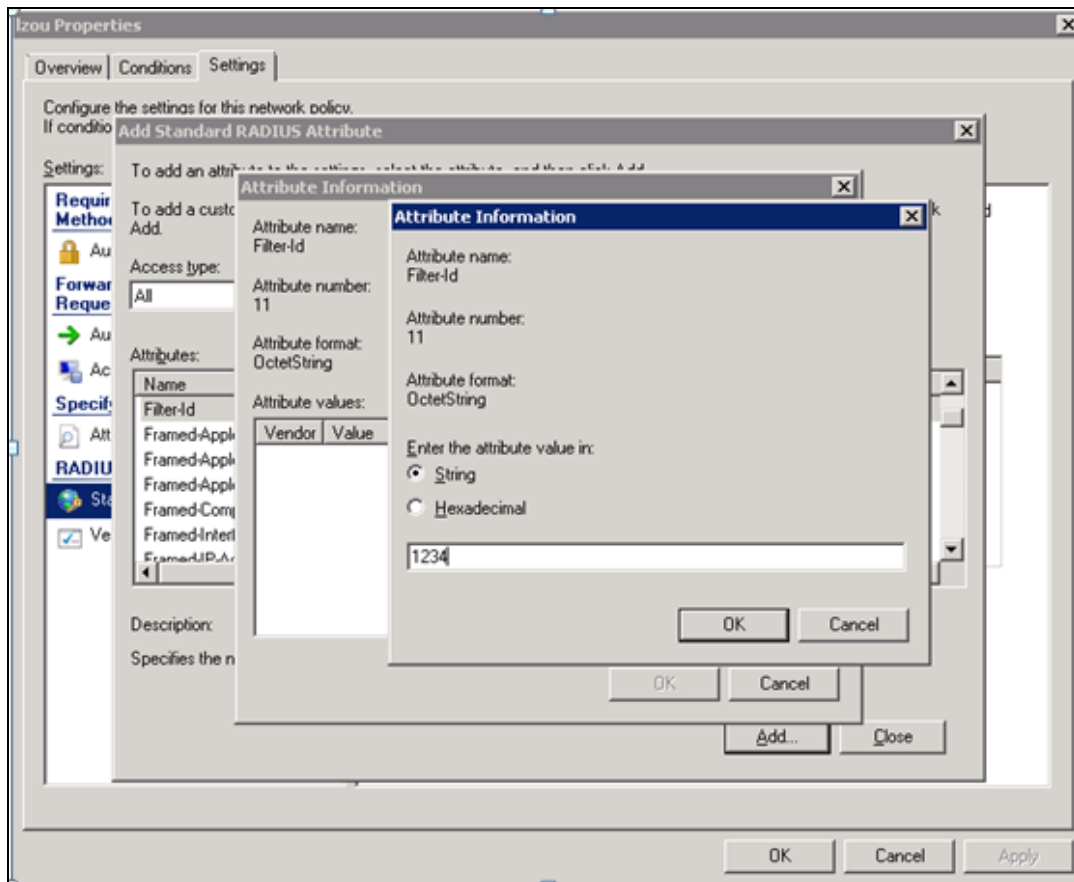

User Role

If the VSA and VLAN derivation rules are not matching, then the user VLAN can be derived by a user role.

VLANs Created for an SSID

If the VSA and VLAN derivation rules are not matching, and the User Role does not contain a VLAN, the user VLAN can be derived by VLANs configured for an SSID or an Ethernet port profile.

Configuring VLAN Derivation Rules

The VLAN derivation rules allow administrators to assign a VLAN to the OAW-IAP clients based on the attributes returned by the RADIUS server.

You can configure VLAN derivation rules for an SSID profile by using the WebUI or the CLI.

In the Old WebUI

To configure VLAN derivation rules:

1. Perform the following steps:
 - To configure VLAN derivation rule for a WLAN SSID profile, navigate to **Network > New > New WLAN > VLAN** or **Network > edit > Edit <WLAN-profile> > VLAN**. Select the **Dynamic** radio button under **Client VLAN assignment**. The **Dynamic** radio button is visible only when the **Client IP assignment** is set to **Network assigned**.

- To configure VLAN derivation rule for a wired network profile, navigate to **Wired > New > New Wired Network > VLAN** or **Wired > Edit > Edit Wired Network > VLAN**. The **VLAN** tab contents are displayed.
2. Under **VLAN Assignment Rules**, click **New** to create a VLAN assignment rule. The **New VLAN Assignment Rule** window is displayed. In this window, you can define a match method by which the string in *Operand* is matched with the attribute values returned by the authentication server.
 3. Select the attribute from the **Attribute** drop-down list. The list of supported attributes includes RADIUS attributes, dhcp-option, dot1x-authentication-type, mac-address, and mac-address-and-dhcp-options. For information on a list of RADIUS attributes, see [RADIUS Server Authentication with VSA on page 194](#).
 4. Select the operator from the **Operator** drop-down list. The following types of operators are supported:
 - **contains**—The rule is applied only if the attribute value contains the string specified in *Operand*.
 - **Is the VLAN**—The rule is applied if the VLAN is the same as the one returned by the RADIUS attribute.
 - **equals**—The rule is applied only if the attribute value is equal to the string specified in *Operand*.
 - **not-equals**—The rule is applied only if the attribute value is not equal to the string specified in *Operand*.
 - **starts-with**—The rule is applied only if the attribute value starts with the string specified in *Operand*.
 - **ends-with**—The rule is applied only if the attribute value ends with the string specified in *Operand*.
 5. Enter the string to match the attribute in the **String** text box.
 6. Select the appropriate VLAN ID from the **VLAN** text box.
 7. Click **OK**.
 8. Ensure that the required security and access parameters are configured.
 9. Click **Finish** to apply the changes.

In the New WebUI

To configure VLAN derivation rules:

1. Perform the following steps:
 - To configure VLAN derivation rule for a WLAN SSID profile or a Wired network, navigate to **Configuration > Networks**.
 - To create a new network, click **+**. To edit an existing network, select the profile and click **Edit**.
 - Select the **VLAN** tab.
 - Set **Client IP assignment** to **Network assigned**.
 - Select the **Dynamic** radio button under **Client VLAN assignment**. This step is applicable only to WLAN profiles.
2. Under **VLAN Assignment Rules**, click **+** to create a VLAN assignment rule. The **New VLAN Assignment Rule** window is displayed. In this window, you can define a match method by which the string in *Operand* is matched with the attribute values returned by the authentication server.
3. Select the attribute from the **Attribute** drop-down list. The list of supported attributes includes RADIUS attributes, dhcp-option, dot1x-authentication-type, mac-address, and mac-address-and-dhcp-options. For information on a list of RADIUS attributes, see [RADIUS Server Authentication with VSA on page 194](#).
4. Select the operator from the **Operator** drop-down list. The following types of operators are supported:
 - **contains**—The rule is applied only if the attribute value contains the string specified in *Operand*.
 - **Is the VLAN**—The rule is applied if the VLAN is the same as the one returned by the RADIUS attribute.
 - **equals**—The rule is applied only if the attribute value is equal to the string specified in *Operand*.
 - **not-equals**—The rule is applied only if the attribute value is not equal to the string specified in *Operand*.
 - **starts-with**—The rule is applied only if the attribute value starts with the string specified in *Operand*.
 - **ends-with**—The rule is applied only if the attribute value ends with the string specified in *Operand*.

- **matches-regular-expression**—The rule is applied only if the attribute value matches the regular expression pattern specified in *Operand*. This operator is available only if the **mac-address-and-dhcp-options** attribute is selected in the **Attribute** drop-down list. The **mac-address-and-dhcp-options** attribute and **matches-regular-expression** are applicable only for the WLAN clients.
5. Enter the string to match the attribute in the **String** text box.
 6. Enter the appropriate VLAN ID in the **VLAN** text box.
 7. Click **OK** and then click **Next**.
 8. Ensure that the required security and access parameters are configured.
 9. Click **Finish** to apply the changes.

In the CLI

To create a VLAN assignment rule for a WLAN SSID:

```
(Instant AP) (config)# wlan ssid-profile <name>
(Instant AP) (SSID Profile <name>)# set-vlan <attribute>{equals|not-equals|starts-with|ends-with|contains}<operator><VLAN-ID>|value-of}
```

To configure a VLAN assignment rule for a wired profile:

```
(Instant AP) (config)# wired-port-profile <nname>
(Instant AP) (wired ap profile <name>)# set-vlan <attribute>{equals|not-equals|starts-with|ends-with|contains}<operator><VLAN-ID>|value-of}
```

Using Advanced Expressions in Role and VLAN Derivation Rules

For complex policies of role and VLAN derivation using device DHCP fingerprints, you can use a Regex to match with the combined string of the MAC address and the DHCP options. The combined string is formed by concatenating the hexadecimal presentation of the MAC address and all of the DHCP options sent by a particular device. The Regex is a powerful pattern description language that can be used to perform advanced pattern matching of the above string.

If the combined device fingerprint string matches the specified Regex, the role or VLAN can be set to the WLAN client.

The following table lists some of the most commonly used Regex, which can be used in user role and user VLAN derivation rules:

Table 62: *Regex*

Operator	Description
.	Matches any character. For example, l..k matches lack, lark, link, lock, look, Lync, and so on.
\	Matches the character that follows the backslash. For example, \192.\0\.. matches IP address ranges that start with 192.0, such as 192.0.1.1. The expression looks up only for the single characters that match.
[]	Matches any one character listed between the brackets. For example, [bc]lock matches block and clock.
\b	Matches the words that begin and end with the given expression. For example, \bdown matches downlink, linkdown, shutdown.
\B	Matches the middle of a word. For example, \Bvice matches services, devices, serviceID, deviceID, and so on.

Operator	Description
^	Matches the characters at starting position in a string. For example, ^bcd matches bcde or bcdf, but not abcd.
[^]	Matches any characters that are not listed between the brackets. For example, [^u]link matches downlink, link, but not uplink.
?	Matches any one occurrence of the pattern. For example, ?est matches best, nest, rest, test, and so on.
\$	Matches the end of an input string. For example, eth\$ matches Eth, but not Ethernet.
*	Matches the declared element multiple times if it exists. For example, eth* matches all occurrences of eth, such as Eth, Ethernet, Eth0, and so on.
+	Matches the declared element one or more times. For example, aa+ matches occurrences of aa and aaa.
()	Matches nested characters. For example, (192)* matches any number of the character string 192.
	Matches the character patterns on either side of the vertical bar. You can use this expression to construct a series of options.
\<	Matches the beginning of the word. For example, \<wire matches wired, wireless, and so on.
\>	Matches the end of the word. For example, \>list matches blacklist, whitelist, and so on.
{n}	Where n is an integer. Matches the declared element exactly n times. For example, {2}link matches uplink, but not downlink.
{n,}	Where n is an integer. Matches the declared element at n times. For example, {2,}ink matches downlink, but not uplink.

For information on how to use a Regex in role and VLAN derivation rules, see the following topics:

- [Creating a Role Derivation Rule on page 266](#)
- [Configuring VLAN Derivation Rules on page 270](#)

Configuring a User Role for VLAN Derivation

This section describes the following procedures:

- [Creating a User VLAN Role on page 273](#)
- [Assigning User VLAN Roles to a Network Profile on page 274](#)

Creating a User VLAN Role

You can create a user role for VLAN derivation using the WebUI or the CLI.

In the Old WebUI

To configure a user role for VLAN derivation:

1. Click the **Security** link located directly above the Search bar in the AOS-W Instant main window.
2. Click the **Roles** tab. The Roles tab contents are displayed.
3. Under **Roles**, click **New**.

4. Enter a name for the new role and click **OK**.
5. Under **Access rules**, click **New**.
6. Select the **Rule type** as **VLAN assignment**.
7. Enter the ID of the VLAN in the **VLAN ID** text box.
8. Click **OK** in the **New Rule** window.
9. Click **OK** in the **Roles** tab.

In the New WebUI

To configure a user role for VLAN derivation:

1. Go to **Configuration > Security**.
2. Expand the **Roles** tab.
3. Under **Roles**, click **+**.
4. Enter a name for the new role and click **OK**.
5. Under **Access rules**, click **+**. The **New rule** window is displayed.
6. Select the **Rule type** as **VLAN assignment**.
7. Enter the ID of the VLAN in the **VLAN ID** text box.
8. Click **OK** in the **New rule** window.
9. Click **Save** in the **Roles** tab.

In the CLI

To create a VLAN role:

```
(Instant AP) (config)# wlan access-rule <rule-name>
(Instant AP) (Access Rule <rule-name>)# vlan 200
```

Assigning User VLAN Roles to a Network Profile

You can configure user VLAN roles for a network profile using WebUI or the CLI.

In the Old WebUI

To assign a user VLAN role:

1. Click **Networks > New > New WLAN > Access** or click **Network > edit > Edit <WLAN-profile > Access**.
2. On the **Access** tab, ensure that the slider is at the **Role-based** option.
3. Click **New** under the **Role Assignment Rules** window. The **New Role Assignment Rule** window is displayed.
4. Configure the following parameters:
 - a. Select the attribute from the **Attribute** drop-down list.
 - b. Select the operator to match attribute from the **Operator** drop-down list.
 - c. Enter the string to match in the **String** text box.
 - d. Select the role to be assigned from the **Role** text box.
5. Click **OK** in the **New Role Assignment Rule** window.
6. Click **Finish** in the **Access** tab.

In the New WebUI

To assign a user VLAN role:

1. Under **Configuration > Networks**, click **+** to create a new WLAN profile or select a network profile to modify and click **Edit**.

2. Select the **Access** tab.
3. Select **Role-based** from the **Access Rules** drop-down list.
4. Click + under the **Role Assignment Rules** window. The **New Role Assignment Rule** window is displayed.
5. Configure the following parameters:
 - a. Select the attribute from the **Attribute** drop-down list.
 - b. Select the operator to match attribute from the **Operator** drop-down list.
 - c. Enter the string to match in the **String** text box.
 - d. Select the role to be assigned from the **Role** text box.
6. Click **OK** in the **New Role Assignment Rule** window.
7. Click **Finish**.

In the CLI

To assign VLAN role to a WLAN profile:

```
(Instant AP) (config)# wlan ssid-profile <name>
(Instant AP) (SSID Profile <name>)# set-role <attribute>{{equals <operator> <role>|not-equals
<operator> <role>|starts-with <operator> <role>|ends-with <operator> <role>|contains
<operator> <role>}}|value-of}
```

This chapter provides the following information:

- [Configuring DHCP Scopes on page 276](#)
- [Configuring the Default DHCP Scope for Client IP Assignment on page 290](#)

Configuring DHCP Scopes

The virtual switch supports different modes of DHCP address assignment. With each DHCP address assignment mode, various client traffic forwarding modes are associated. For more information on client traffic forwarding modes for IAP-VPN, see [IAP-VPN Forwarding Modes on page 312](#).

When using a local DHCP scope in an OAW-IAP cluster, ensure that the VLANs configured for this DHCP scope is allowed in the uplink switch.



In a single OAW-IAP network, when using a client DHCP scope for wired clients, ensure that client VLAN is not added in the allowed VLAN list for the port to which the OAW-IAP Ethernet 0 port is connected.

This section describes the following procedures:

- [Configuring Local DHCP Scopes on page 276](#)
- [Configuring Distributed DHCP Scopes on page 280](#)
- [Enabling DHCP Relay Agent Information Option \(Option 82\) on page 284](#)
- [Enabling DHCP Relay Agent Information Option \(Option 82\) on page 284](#)

Configuring Local DHCP Scopes

You can configure Local, Local L2, and Local L3 DHCP scopes through the WebUI or the CLI.

- **Local**—In this mode, the virtual switch acts as both the DHCP server and the default gateway. The configured subnet and the corresponding DHCP scope are independent of the subnets configured in other OAW-IAP clusters. The virtual switch assigns an IP address from a local subnet and forwards traffic to both **corporate** and **non-corporate** destinations. The network address is translated appropriately and the packet is forwarded through the IPsec tunnel or through the uplink. This DHCP assignment mode is used in the NAT forwarding mode.
- **Local, L2**—In this mode, the virtual switch acts as a DHCP server and the gateway located outside the OAW-IAP.
- **Local, L3**—This DHCP assignment mode is used with the L3 forwarding mode. In this mode, the virtual switch acts as a DHCP server and the gateway, and assigns an IP address from the local subnet. The OAW-IAP routes the packets sent by clients on its uplink. The Local L3 subnets can access corporate network through the IPsec tunnel. The network address for all client traffic, which is generated in the Local L3 subnets and destined to the corporate network, is translated at the source with the tunnel inner IP. However, if corporate access to Local L3 is not required, you can configure ACL rules to deny access.

In the Old WebUI

To configure a Local or a Local L3 DHCP scope:

1. Click **More > DHCP Server**. The **DHCP Servers** window is displayed.

2. To configure a **Local, Local, L2**, or **Local, L3** DHCP scope, click **New** under **Local DHCP Scopes**. The **New DHCP Scope** window is displayed.
3. Based on the type of DHCP scope selected, configure the following parameters:

Table 63: Local DHCP Mode Configuration Parameters

Parameter	Description
Name	Enter a name for the DHCP scope.
Type	Select any of the following options: <ul style="list-style-type: none"> ■ Local—On selecting Local, the DHCP server for local branch network is used for keeping the scope of the subnet local to the OAW-IAP. In the NAT mode, the traffic is forwarded through the IPsec tunnel or the uplink. ■ Local, L2—On selecting Local, L2, the virtual switch acts as a DHCP server and a default gateway in the local network that is used. ■ Local, L3—On selecting Local, L3, the virtual switch acts as a DHCP server and a gateway. In this mode, the network address for traffic destined to the corporate network is translated at the source with the inner IP of the IPsec tunnel and is forwarded through the IPsec tunnel. The traffic destined to the non-corporate network is routed.
VLAN	Specify a VLAN ID. To use this subnet, ensure that the VLAN ID specified here is assigned to an SSID profile. For more information on SSID profile configuration, see Configuring VLAN Settings for a WLAN SSID Profile on page 108 and Configuring VLAN for a Wired Profile on page 136 .
Network	Specify the network to use.
Netmask	If Local, Local, L2 , or Local, L3 is selected, specify the subnet mask. The subnet mask and the network determine the size of the subnet.
Excluded address	Specify a range of IP addresses to exclude. You can add up to two exclusion ranges. Based on the size of the subnet and the value configured for Excluded address , the IP addresses either before or after the defined range are excluded.
Default Router	If Local, L2 is selected for type of DHCP scope, specify the IP address of the default router.
DNS Server	If required, specify the IP address of a DNS server for the Local; Local, L2; and Local, L3 scopes. You can configure up to 4 DNS servers for each DHCP scope.
Domain Name	If required, specify the domain name for the Local; Local, L2; and Local, L3 scopes.
Lease Time	Specify a lease time for the client in minutes within a range of 2–1440 minutes. The default value is 720 minutes.
Option	Specify the type and a value for the DHCP option. You can configure the organization-specific DHCP options supported by the DHCP server. For example, 176, 242, and 161. Click + to add multiple DHCP options.

4. Click **OK**.
5. Click **OK** in the **DHCP Servers** window.

In the New WebUI

To configure a Local or a Local L3 DHCP scope:

1. Click **Configuration > DHCP Server**. The **DHCP Servers** window is displayed.
2. To configure a **Local, Local,L2**, or **Local,L3** DHCP scope, click + under **Local DHCP Scopes**.
3. Based on the type of DHCP scope selected, configure the following parameters:

Table 64: Local DHCP Mode Configuration Parameters

Parameter	Description
Name	Enter a name for the DHCP scope.
Type	Select any of the following options: <ul style="list-style-type: none"> ■ Local—On selecting Local, the DHCP server for local branch network is used for keeping the scope of the subnet local to the OAW-IAP. In the NAT mode, the traffic is forwarded through the IPsec tunnel or the uplink. ■ Local,L2—On selecting Local,L2, the virtual switch acts as a DHCP server and a default gateway in the local network that is used. ■ Local,L3—On selecting Local,L3, the virtual switch acts as a DHCP server and a gateway. In this mode, the network address for traffic destined to the corporate network is translated at the source with the inner IP of the IPsec tunnel and is forwarded through the IPsec tunnel. The traffic destined to the non-corporate network is routed.
VLAN	Specify a VLAN ID. To use this subnet, ensure that the VLAN ID specified here is assigned to an SSID profile. For more information on SSID profile configuration, see Configuring VLAN Settings for a WLAN SSID Profile on page 108 and Configuring VLAN for a Wired Profile on page 136 .
Network	Specify the network to use.
Netmask	If Local , Local,L2 , or Local,L3 is selected, specify the subnet mask. The subnet mask and the network determine the size of the subnet.
Excluded address	Specify a range of IP addresses to exclude. You can add up to two exclusion ranges. Based on the size of the subnet and the value configured for Excluded address , the IP addresses either before or after the defined range are excluded.
Default router	If Local,L2 is selected for type of DHCP scope, specify the IP address of the default router.
DNS server	If required, specify the IP address of a DNS server for the Local ; Local,L2 ; and Local,L3 scopes. You can configure up to 4 DNS servers for each DHCP scope.
Domain name	If required, specify the domain name for the Local ; Local,L2 ; and Local,L3 scopes.
Lease time	Specify a lease time for the client in minutes within a range of 2-1440 minutes. The default value is 720 minutes.
Option	Specify the type and a value for the DHCP option. You can configure the organization-specific DHCP options supported by the DHCP server. For example, 176, 242, and 161. Click + to add multiple DHCP options.

4. Click **OK**.
5. Click **Save** in the **DHCP Servers** window.

In the CLI

To configure a Local DHCP scope:

```
(Instant AP) (config)# ip dhcp <profile-name>
(Instant AP) (DHCP Profile <profile-name>)# server-type <local>
(Instant AP) (DHCP Profile <profile-name>)# server-vlan <vlan-ID>
(Instant AP) (DHCP Profile <profile-name>)# subnet <IP-address>
(Instant AP) (DHCP Profile <profile-name>)# subnet-mask <subnet-mask>
(Instant AP) (DHCP Profile <profile-name>)# dns-server <dns_server>
(Instant AP) (DHCP Profile <profile-name>)# domain-name <domain-name>
(Instant AP) (DHCP Profile <profile-name>)# lease-time <seconds>
(Instant AP) (DHCP Profile <profile-name>)# option <type> <value>
```

To configure a Local L2 DHCP scope:

```
(Instant AP) (config)# ip dhcp <profile-name>
(Instant AP) (DHCP Profile <profile-name>)# server-type <local,l2>
(Instant AP) (DHCP Profile <profile-name>)# server-vlan <vlan-ID>
(Instant AP) (DHCP Profile <profile-name>)# subnet <IP-address>
(Instant AP) (DHCP Profile <profile-name>)# subnet-mask <subnet-mask>
(Instant AP) (DHCP Profile <profile-name>)# exclude-address <IP-address>
(Instant AP) (DHCP Profile <profile-name>)# default-router
(Instant AP) (DHCP Profile <profile-name>)# dns-server <dns_server>
(Instant AP) (DHCP Profile <profile-name>)# domain-name <domain-name>
(Instant AP) (DHCP Profile <profile-name>)# lease-time <seconds>
(Instant AP) (DHCP Profile <profile-name>)# option <type> <value>
```

To configure a Local L3 DHCP scope:

```
(Instant AP) (config)# ip dhcp <profile-name>
(Instant AP) (DHCP Profile <profile-name>)# server-type <local,l3>
(Instant AP) (DHCP Profile <profile-name>)# server-vlan <vlan-ID>
(Instant AP) (DHCP Profile <profile-name>)# subnet <IP-address>
(Instant AP) (DHCP Profile <profile-name>)# subnet-mask <subnet-mask>
(Instant AP) (DHCP Profile <profile-name>)# exclude-address <IP-address>
(Instant AP) (DHCP Profile <profile-name>)# dns-server <dns_server>
(Instant AP) (DHCP Profile <profile-name>)# domain-name <domain-name>
(Instant AP) (DHCP Profile <profile-name>)# lease-time <seconds>
(Instant AP) (DHCP Profile <profile-name>)# option <type> <value>
```

VLAN and Default Router Settings

AOS-W Instant supports DHCP scopes in which both, the DHCP server and the default gateway on a virtual switch can configure a default gateway IP address. For the Centralized,L3, Local, Local,L2, and Local,L3 scopes, an option is introduced to configure a VLAN IP address to the existing service VLAN of a DHCP pool. This feature can prevent changes that may occur in DHCP range exclusions.

You can configure a local DHCP profile by using the WebUI or CLI.

In the Old WebUI

To configure a default router and VLAN parameters in a local DHCP profile:

1. Click **More > DHCP Server**. The **DHCP Servers** window is displayed.
2. To configure a local DHCP scope, click **New** under **Local DHCP Scopes**. The **New DHCP Scope** window is displayed.
3. Select the **Type** and configure the parameters available in the WebUI. The **Default router** parameter can be set on Local and Local L3 profiles. The **VLAN IP** and **Netmask** parameters can be set only on the Local L2 profile.
4. Click **OK**.

In the New WebUI

To configure a default router and VLAN parameters in a local DHCP profile:

1. Click **Configuration > DHCP Server**. The **DHCP Servers** window is displayed.
2. To configure a local DHCP scope, click **+** under **Local DHCP Scopes**. The **New DHCP Scope** window is displayed.
3. Select the **Type** and configure the parameters available in the WebUI. The **Default router** parameter can be set on Local and Local L3 profiles. The **VLAN IP** and **VLAN mask** parameters can be set only on the Local L2 profile.
4. Click **OK**.

In the CLI

To configure VLAN IP in a Local DHCP profile:

```
(Instant AP) (config)# ip dhcp <profile-name>
(Instant AP) (DHCP Profile <profile-name>)# vlan-ip <VLAN_IP> mask <VLAN mask>
```

To configure a default router in a Local DHCP profile:

```
(Instant AP) (config)# ip dhcp <profile-name>
(Instant AP) (DHCP Profile <profile-name>)# default-router <default_router>
```



The value of the VLAN IP and default router for the Local or Local,L3 profile must be the same.

Configuring Distributed DHCP Scopes

AOS-W Instant allows you to configure the DHCP address assignment for the branches connected to the corporate network through VPN. You can configure the range of DHCP IP addresses used in the branches and the number of client addresses allowed per branch. You can also specify the IP addresses that must be excluded from those assigned to clients, so that they are assigned statically.

AOS-W Instant supports the following distributed DHCP scopes:

- **Distributed, L2**—In this mode, the virtual switch acts as the DHCP server, but the default gateway is in the data center. Based on the number of clients specified for each branch, the range of IP addresses is divided. Based on the IP address range and client count configuration, the DHCP server in the virtual switch controls a scope that is a subset of the complete IP address range for the subnet distributed across all the branches. This DHCP assignment mode is used with the L2 forwarding mode.
- **Distributed, L3**—In this mode, the virtual switch acts as the DHCP server and the default gateway. Based on the number of clients specified for each branch, the range of IP addresses is divided. Based on the IP address range and client count configuration, the DHCP server in the virtual switch is configured with a unique subnet and a corresponding scope.

You can configure distributed DHCP scopes such as Distributed L2 or Distributed L3 by using the WebUI or the CLI.

In the Old WebUI

To configure distributed DHCP scopes such as Distributed L2 or Distributed L3:

1. Click **More** > **DHCP Server**. The **DHCP Servers** window is displayed.
2. To configure a distributed DHCP mode, click **New** under **Distributed DHCP Scopes**. The **New DHCP Scope** window is displayed.
3. Based on the type of distributed DHCP scope, configure the following parameters in the **Network** tab:

Table 65: Distributed DHCP Mode Configuration Parameters

Parameter	Description
Name	Enter a name for the DHCP scope.
Type	Select any of the following options: <ul style="list-style-type: none"> ■ Distributed, L2—On selecting Distributed, L2, the virtual switch acts as the DHCP server but the default gateway is in the data center. Traffic is bridged into VPN tunnel. ■ Distributed, L3—On selecting Distributed, L3, the virtual switch acts as both DHCP server and default gateway. Traffic is routed into the VPN tunnel.
VLAN	Specify a VLAN ID. To use this subnet, ensure that the VLAN ID specified here is assigned to an SSID profile. For more information on SSID profile configuration, see Configuring VLAN Settings for a WLAN SSID Profile on page 108 and Configuring VLAN for a Wired Profile on page 136 .
Netmask	If Distributed, L2 is selected for the type of DHCP scope, specify the subnet mask. The subnet mask and the network determine the size of subnet.
Default router	If Distributed, L2 is selected for the type of DHCP scope, specify the IP address of the default router.
DNS server	If required, specify the IP address of a DNS server. You can configure upto four DNS servers at the same time. Use commas to separate the DNS servers.
Domain name	If required, specify the domain name.
Lease time	Specify a lease time for the client in minutes within a range of 2–1440 minutes. The default value is 720 minutes.
Dynamic DNS	Select the Dynamic DNS check box to enable dynamic DNS on the Distributed L3 client. Key —Enter the TSIG shared secret key.
IP Address Range	Specify a range of IP addresses to use. Click + to add another range. You can specify up to four different ranges of IP addresses. <ul style="list-style-type: none"> ■ For the Distributed, L2 mode, ensure that all IP ranges are in the same subnet as the default router. On specifying the IP address ranges, a subnet validation is performed to ensure that the specified ranges of IP address are in the same subnet as the default router and subnet mask. The configured IP range is divided into blocks based on the configured client count. ■ For the Distributed, L3 mode, you can configure any discontinuous IP ranges. The configured IP range is divided into multiple IP subnets that are sufficient to accommodate the configured client count. NOTE: You can allocate multiple branch IDs per subnet. The OAW-IAP generates a subnet name from the DHCP IP configuration, which the switch can use as a subnet identifier. If static subnets are configured in each branch, all of them are assigned the with branch ID 0, which is mapped directly to the configured static subnet.
Option	Specify the type and a value for the DHCP option. You can configure the organization-specific DHCP options supported by the DHCP server. For example, 176, 242, 161, and so on. Click + to add multiple DHCP options. You can add up to eight DHCP options.

4. Click **Next**.

5. In the **Branch Size** tab, specify the number of clients to use per branch in the **Clients per branch** text box. The client count configured for a branch determines the use of IP addresses from the IP address range defined for a DHCP scope. For example, if 20 IP addresses are available in an IP address range configured for a DHCP scope and a client count of 9 is configured, only a few IP addresses (in this example, 9) from this

range will be used and allocated to a branch. The OAW-IAP does not allow the administrators to assign the remaining IP addresses to another branch, although a lower value is configured for the client count.

6. Click **Next**. The **Static IP** tab is displayed.
7. In the **Reserve first** and **Reserve last** text boxes, specify the number of first and last IP addresses to reserve in the subnet.
8. Click **Finish**.
9. Click **OK** in the **DHCP Servers** window.

In the New WebUI

To configure distributed DHCP scopes such as Distributed L2 or Distributed L3:

1. Click **Configuration > DHCP Server**. The **DHCP Servers** window is displayed.
2. To configure a distributed DHCP mode, click **+** under **Distributed DHCP Scopes**. The **New DHCP Scope** window is displayed.
3. Based on the type of distributed DHCP scope, configure the following parameters in the **Network** tab:

Table 66: *Distributed DHCP Mode Configuration Parameters*

Parameter	Description
Name	Enter a name for the DHCP scope.
Type	Select any of the following options: <ul style="list-style-type: none"> ■ Distributed,L2—On selecting Distributed,L2, the virtual switch acts as the DHCP server but the default gateway is in the data center. Traffic is bridged into VPN tunnel. ■ Distributed,L3—On selecting Distributed,L3, the virtual switch acts as both DHCP server and default gateway. Traffic is routed into the VPN tunnel.
VLAN	Specify a VLAN ID. To use this subnet, ensure that the VLAN ID specified here is assigned to an SSID profile. For more information on SSID profile configuration, see Configuring VLAN Settings for a WLAN SSID Profile on page 108 and Configuring VLAN for a Wired Profile on page 136 .
Netmask	If Distributed,L2 is selected for the type of DHCP scope, specify the subnet mask. The subnet mask and the network determine the size of subnet.
Default router	If Distributed,L2 is selected for the type of DHCP scope, specify the IP address of the default router.
DNS server	If required, specify the IP address of a DNS server. You can configure up to four DNS servers at the same time. Use commas to separate the DNS servers.
Domain name	If required, specify the domain name.
Lease time	Specify a lease time for the client in minutes within a range of 2–1440 minutes. The default value is 720 minutes.

Table 66: Distributed DHCP Mode Configuration Parameters

Parameter	Description
Dynamic DNS	Click the Dynamic DNS toggle switch to enable dynamic DNS on the Distributed L3 client. Key —Enter the TSIG shared secret key.
IP Address Range	Specify a range of IP addresses to use. Click + to add another range. You can specify up to four different ranges of IP addresses. <ul style="list-style-type: none"> For the Distributed, L2 mode, ensure that all IP ranges are in the same subnet as the default router. On specifying the IP address ranges, a subnet validation is performed to ensure that the specified ranges of IP address are in the same subnet as the default router and subnet mask. The configured IP range is divided into blocks based on the configured client count. For the Distributed,L3 mode, you can configure any discontinuous IP ranges. The configured IP range is divided into multiple IP subnets that are sufficient to accommodate the configured client count. NOTE: You can allocate multiple branch IDs per subnet. The OAW-IAP generates a subnet name from the DHCP IP configuration, which the switch can use as a subnet identifier. If static subnets are configured in each branch, all of them are assigned the with branch ID 0, which is mapped directly to the configured static subnet.
Option	Specify the type and a value for the DHCP option. You can configure the organization-specific DHCP options supported by the DHCP server. For example, 176, 242, 161, and so on. Click + to add multiple DHCP options. You can add up to eight DHCP options.

4. Click **Next**.

5. In the **Branch Size** tab, specify the number of clients to use per branch in the **Clients per branch** text box. The client count configured for a branch determines the use of IP addresses from the IP address range defined for a DHCP scope. For example, if 20 IP addresses are available in an IP address range configured for a DHCP scope and a client count of 9 is configured, only a few IP addresses (in this example, 9) from this range will be used and allocated to a branch. The OAW-IAP does not allow the administrators to assign the remaining IP addresses to another branch, although a lower value is configured for the client count.

6. Click **Next**. The **Static IP** tab is displayed.

7. In the **Reserve first** and **Reserve last** text boxes, specify the number of first and last IP addresses to reserve in the subnet.

8. Click **Finish**.

9. Click **Save** in the **DHCP Servers** window.

In the CLI

To configure a Distributed L2 DHCP scope:

```
(Instant AP) (config)# ip dhcp <profile-name>
(Instant AP) (DHCP Profile <profile-name>)# ip dhcp server-type <Distributed,L2>
(Instant AP) (DHCP Profile <profile-name>)# server-vlan <vlan-ID>
(Instant AP) (DHCP Profile <profile-name>)# subnet-mask <subnet-mask>
(Instant AP) (DHCP Profile <profile-name>)# default-router <IP-address>
(Instant AP) (DHCP Profile <profile-name>)# client-count <number>
(Instant AP) (DHCP Profile <profile-name>)# dns-server <name>
(Instant AP) (DHCP Profile <profile-name>)# domain-name <domain-name>
(Instant AP) (DHCP Profile <profile-name>)# lease-time <seconds>
(Instant AP) (DHCP Profile <profile-name>)# ip-range <start-IP> <end-IP>
(Instant AP) (DHCP Profile <profile-name>)# reserve {first|last} <count>
(Instant AP) (DHCP Profile <profile-name>)# option <type> <value>
```

To configure a Distributed L3 DHCP scope:

```

(Instant AP) (config)# ip dhcp <profile-name>
(Instant AP) (DHCP Profile <profile-name>)# ip dhcp server-type <Distributed,L3>
(Instant AP) (DHCP Profile <profile-name>)# server-vlan <vlan-ID>
(Instant AP) (DHCP Profile <profile-name>)# client-count <number>
(Instant AP) (DHCP Profile <profile-name>)# dns-server <name>
(Instant AP) (DHCP Profile <profile-name>)# domain-name <domain-name>
(Instant AP) (DHCP Profile <profile-name>)# lease-time <seconds>
(Instant AP) (DHCP Profile <profile-name>)# dynamic-dns [key <TSIG KEY>]
(Instant AP) (DHCP Profile <profile-name>)# ip-range <start-IP> <end-IP>
(Instant AP) (DHCP Profile <profile-name>)# reserve {first|last} <count>
(Instant AP) (DHCP Profile <profile-name>)# option <type> <value>

```

Enabling DHCP Relay Agent Information Option (Option 82)

The DHCP Relay Agent Information option (Option 82) allows the DHCP Relay Agent to insert circuit specific information into a request that is being forwarded to a DHCP server.

The master OAW-IAP, when acting as a DHCP relay agent, inserts information about the slave OAW-IAP and SSID through which a client connects to the DHCP request. Many service providers use this mechanism to make access control decisions.

Option 82 can be customized to cater to the requirements of any ISP using the master OAW-IAP. To facilitate customization using a XML definition, multiple parameters for Circuit ID and Remote ID options of DHCP Option 82 have been introduced. The XML file is used as the input from the user and is validated against an XSD file in the master OAW-IAP. The format in the XML file is parsed and stored in the DHCP relay which is used to insert Option 82 related values in the DHCP request packets sent from the client to the server.

When IP Helper is enabled on an L3 interface, DHCP discover broadcast is filtered at the datapath level and is unicast to the configured helper device.



DHCP Option-82 is supported only for IPv4.

DHCP Option-82 on L2 VLAN can be enabled without the helper address.

Sample XML Format

The following is a sample XML file which specifies DHCP Option-82 circuit and remote IDs.

```

<?xml version="1.0" encoding="UTF-8"?>
  <dhcpopt82>
    <circuit_id>
      <param>
        <type>var</type>
        <val>apmac</val>
        <delim>-</delim>
      </param>
    </circuit_id>
    <remote_id>
      <param>
        <type>var</type>
        <val>uemac</val>
        <delim>:</delim>
      </param>
    </remote_id>
  </dhcpopt82>

```

The table below lists the elements introduced in the **param** sub-options of the **Circuit ID** and **Remote ID** fields:

XML File Parameters

Parameter	Description
Type	Listed below are the types available: <ul style="list-style-type: none"> ■ var-A DHCP option-82 allowed keyword ■ hex-A hexadecimal string with a maximum of 64 characters ■ str-An ASCII string with a maximum of 64 characters
Val	This field contains either a hexadecimal string or ASCII string limited to 64 characters, if the type is hex or str. If the type is var then one of the following DHCP option-82 keywords: <ul style="list-style-type: none"> ■ apname/APNAME-AP name ■ apgrpname/APGRPNAME-AP group name (zone name) ■ apmac/APMAC-AP MAC ■ ssid/SSID-SSID Type ■ bssid/BSSID-BSSID of AP ■ uemac/UEMAC-User MAC (Client)
Delim	The delim option is available only for mac based keywords - apmac/APMAC , uemac/UEMAC , and bssid/BSSID . The delim field is used if MAC addresses are required to be in ASCII format with octets separated with either a colon (:) or a hyphen (-). By default, the ASCII MAC separated by a delimiter, will be in lower case. If the user wants to use upper case then the respective MAC-based val keywords must be written in upper case in XML file. For example: <pre><param> <type>var</type> <val>UEMAC</val> <delim>:</delim> </param></pre> If the delim field is not present in MAC-based keywords, then the MAC addresses are sent in option82 in hexadecimal format. For example: <pre><param> <type>var</type> <val>apmac</val> (sent in hex format) </param></pre>

Configuring XML Based DHCP Option 82 Specification

Listed below is the sequence of steps to be followed if a user wants to use XML based DHCP option 82:

1. From the master OAW-IAP, upload the XML file containing Option 82 specification to flash using the **download-dhcpopt82 xml <URL>** command. For example:

```
(Instant AP) #download-dhcpopt82 xml http://10.20.52.131/dhcp_option82_1.xml
```



If the XML file is not in the specified format, then the incorrect file will not be loaded to flash. This can be checked using the **show dhcp opt82 xml-config** command, where the load status will be set to **Success** or **Fail**. If the load fails, the error is displayed in the output of the **show dhcp opt82 xml-config** command.

2. In the configuration terminal, execute the following command:

```
(Instant AP) (config) #dhcp option82-xml <mydhcpoption82.xml>
```

The XML file is always saved in flash with the name **mydhcpoption82.xml**. For example:

```
(Instant AP) (config) # dhcp option82-xml mydhcpoption82.xml
```

You can see the parameters configured for Option 82 by executing the **show dhcp opt82 xml-config** command.



This command is not successful if the **option82 alu** parameter is enabled in any of the centralized L2 or L3 DHCP profiles. If **option82 alu** is enabled, then disable it in the respective DHCP profile using the **no option82** parameter.

3. After the **dhcp option82-xml mydhcproption82.xml** command is executed, then execute the **dhcp option82 xml** command in a centralized L2 or L3 DHCP profile configuration to apply the **option82 xml** configuration to the DHCP packets that need to be relayed from that centralized L2 or L3 DHCP profile.

For example:

```
(Instant AP) (config) # ip dhcp <profile-name>
(Instant AP) (DHCP Profile <profile-name>)# server-type <centralized>
(Instant AP) (DHCP Profile <profile-name>)# server-vlan <vlan-ID>
(Instant AP) (DHCP Profile <profile-name>) # option82 xml
```

4. Execute the following command if the user wants to remove global option82 configuration:

```
(Instant AP) (config)# no dhcp option82-xml
```



This command is not successful if there is a DHCP profile configured with the **option82 xml** parameter. To remove the **option82 xml** configuration, go to the respective DHCP profile and execute the **no option82** command, and then execute the **no dhcp option82-xml** command.

If there are multiple centralized L2 or L3 DHCP profiles configured, each profile can have only one type of Option 82 configured at the same time. For example, no two or more profiles can have **option82 xml** and **option82 alu** enabled at the same time.

Configuring ALU Based DHCP Option 82 Specification

1. The Alcatel based DHCP Option 82 configuration in a DHCP profile is similar to the XML-based configuration.

For example:

```
(Instant AP) (config)# ip dhcp <profile-name>
(Instant AP) (DHCP Profile <profile-name>)# server-type <centralized>
(Instant AP) (DHCP Profile <profile-name>)# server-vlan <vlan-ID>
(Instant AP) (DHCP Profile <profile-name>)# option82 alu
```

Before you configure the **option82 alu** parameter in any of the centralized L2 or L3 DHCP profiles, ensure that no other DHCP profile is configured with **option82 xml**, from the specific DHCP profile. Disable it using the **no option82** command and ensure that the global XML configuration is not enabled. Now, disable it using the **no dhcp option82-xml** command in configuration mode.

2. To remove ALU based Option 82 configuration, execute the **no option82** command from the specific DHCP profile.

```
(Instant AP) (config)# ip dhcp <profile-name>
(Instant AP) (DHCP Profile <profile-name>)# no option82
```

Configuring Centralized DHCP Scopes

When a centralized DHCP scope is configured, the following points are to be noted:

- The virtual switch does not assign an IP address to the client and the DHCP traffic is directly forwarded to the DHCP server.
- For Centralized L2 clients, the virtual switch bridges the DHCP traffic to the switch over the VPN or GRE tunnel. The IP address is obtained from the DHCP server behind the switch serving the VLAN or GRE of the client. This DHCP assignment mode also allows you to add the DHCP option 82 to the DHCP traffic forwarded to the switch. You can configure up to 32 VLAN IDs in a single DHCP profile when split-tunnel is disabled. Totally 192 VLAN IDs can be configured for Centralized, L2 clients, 32 VLAN IDs per Centralized, L2 DHCP scope.

- For Centralized L3 clients, the virtual switch acts as a DHCP relay agent that forwards the DHCP traffic to the DHCP server located either in the corporate or local network. The Centralized L3 VLAN IP is used as the source IP. The IP address is obtained from the DHCP server.

You can configure a centralized DHCP scope through the WebUI or the CLI.

In the Old WebUI

To configure a centralized DHCP scope:

1. Click **More > DHCP Server**. The **DHCP Servers** window is displayed.
2. To configure a centralized DHCP scope, click **New** under **Centralized DHCP Scopes**. The **New DHCP Scopes** window is displayed.
3. To configure a centralized profile, select the profile type as **Centralized, L2** or **Centralized, L3** and configure the following parameters.

Table 67: Centralized DHCP Mode Configuration Parameters

Parameter	Description
Name	Enter a name for the DHCP scope.
Type	Set the type as follows: <ul style="list-style-type: none"> ■ Centralized, L2 for the Centralized L2 profile ■ Centralized, L3 for the Centralized L3 profile
VLAN	Specify a VLAN ID. You can specify up to 32 VLAN IDs for Centralized, L2. To use this subnet, ensure that the VLAN ID specified here is assigned to an SSID profile. For more information on SSID profile configuration, see Configuring VLAN Settings for a WLAN SSID Profile on page 108 and Configuring VLAN for a Wired Profile on page 136 .
Split tunnel	Set this to Enabled or Disabled for split tunnel functionality for the Centralized L2 subnet. Enabling split tunnel allows a VPN user to access a public network and a local LAN or WAN network at the same time through the same physical network connection. For example, a user can use a remote access VPN software client connecting to a corporate network using a home wireless network. The user with split tunneling enabled is able to connect to file servers, database servers, mail servers, and other servers on the corporate network through the VPN connection. When the user connects to Internet resources (websites, FTP sites, and so on), the connection request goes directly to the gateway provided by the home network. The split-DNS functionality intercepts DNS requests from clients for non-corporate domains (as configured in Enterprise Domains list) and forwards to the OAW-IAP's own DNS server. When split-tunnel is disabled, all the traffic including the corporate and Internet traffic is tunneled irrespective of the routing profile specifications. If the GRE tunnel is down and when the corporate network is not reachable, the client traffic is dropped.
DHCP relay	If you are configuring a Centralized L2 DHCP profile, you can select Enabled to allow the OAW-IAPs to intercept the broadcast packets and relay DHCP requests to the centralized DHCP server. NOTE: The DHCP relay option is not available for Centralized L3 profile configuration.
Helper address	Specify the IP address of the DHCP server. NOTE: For Centralized L3 DHCP profiles, the Helper address option is displayed only when DHCP relay is enabled.

Table 67: Centralized DHCP Mode Configuration Parameters

Parameter	Description
VLAN IP	Specify the Centralized L3 DHCP subnet gateway IP.
VLAN Mask	Specify the subnet mask of the Centralized L3 DHCP subnet gateway IP.
Option 82	<p>Select Alcatel to enable DHCP Option 82 and allow clients to send DHCP packets with the Option 82 string. The Option 82 string is available only in the Alcatel format. The Alcatel format for the Option 82 string consists of the following:</p> <ul style="list-style-type: none"> ■ Remote Circuit ID; X AP-MAC; SSID; SSID-Type ■ Remote Agent; X IDUE-MAC <p>NOTE: The Option 82 string is specific to Alcatel and is not configurable.</p>

4. Click **OK**.
5. Click **OK** in the **DHCP Servers** window.

In the New WebUI

To configure a centralized DHCP scope:

1. Navigate to the **Configuration > DHCP Server** page.
2. To configure a centralized DHCP scope, click **+** under **Centralized DHCP Scopes**.
3. To configure a centralized profile, select the profile type as **Centralized,L2** or **Centralized,L3** and configure the following parameters.

Table 68: Centralized DHCP Mode Configuration Parameters

Parameter	Description
Name	Enter a name for the DHCP scope.
Type	<p>Set the type as follows:</p> <ul style="list-style-type: none"> ■ Centralized,L2 for the Centralized L2 profile ■ Centralized,L3 for the Centralized L3 profile
VLAN	Specify a VLAN ID. To use this subnet, ensure that the VLAN ID specified here is assigned to an SSID profile. For more information on SSID profile configuration, see Configuring VLAN Settings for a WLAN SSID Profile on page 108 and Configuring VLAN for a Wired Profile on page 136 .
Split tunnel	<p>Click the toggle switch depending on whether you want to enable or disable the split tunnel functionality for the Centralized L2 subnet.</p> <p>Enabling split tunnel allows a VPN user to access a public network and a local LAN or WAN network at the same time through the same physical network connection. For example, a user can use a remote access VPN software client connecting to a corporate network using a home wireless network. The user with split tunneling enabled is able to connect to file servers, database servers, mail servers, and other servers on the corporate network through the VPN connection. When the user connects to Internet resources (websites, FTP sites, and so on), the connection request goes directly to the gateway provided by the home network. The split-DNS functionality intercepts DNS requests from clients for non-corporate domains (as configured in Enterprise Domains list) and forwards to the OAW-IAP's own DNS server.</p> <p>When split-tunnel is disabled, all the traffic including the corporate and Internet traffic is tunneled irrespective of the routing profile specifications. If the GRE tunnel is down and when the corporate network is not reachable, the client traffic is dropped.</p>

Table 68: Centralized DHCP Mode Configuration Parameters

Parameter	Description
DHCP relay	If you are configuring a Centralized L2 DHCP profile, click the the DHCP relay toggle switch to allow the OAW-IAPs to intercept the broadcast packets and relay DHCP requests to the centralized DHCP server. NOTE: The DHCP relay option is not available for Centralized L3 profile configuration.
Helper address	Specify the IP address of the DHCP server. NOTE: For Centralized L3 DHCP profiles, the Helper address option is displayed only when DHCP relay is enabled.
VLAN IP	Specify the Centralized L3 DHCP subnet gateway IP.
VLAN Mask	Specify the subnet mask of the Centralized L3 DHCP subnet gateway IP.
Option 82	Select Alcatel to enable DHCP Option 82 and allow clients to send DHCP packets with the Option 82 string. The Option 82 string is available only in the Alcatel format. The Alcatel format for the Option 82 string consists of the following: <ul style="list-style-type: none"> ■ Remote Circuit ID; X AP-MAC; SSID; SSID-Type ■ Remote Agent; X IDUE-MAC NOTE: The Option 82 string is specific to Alcatel and is not configurable.

4. Click **OK**.

5. Click **Save** in the **DHCP Servers** window.

The following table describes the behavior of the DHCP Relay Agent and Option 82 in the OAW-IAP.

Table 69: DHCP Relay and Option 82

DHCP Relay	Option 82	Result
Enabled	Enabled	DHCP packet relayed with the ALU-specific Option 82 string
Enabled	Disabled	DHCP packet relayed without the ALU-specific Option 82 string
Disabled	Enabled	DHCP packet not relayed, but broadcast with the ALU-specific Option 82 string
Disabled	Disabled	DHCP packet not relayed, but broadcast without the ALU-specific Option 82 string

In the CLI

To configure a Centralized L2 DHCP profile:

```
(Instant AP) (config)# ip dhcp <profile-name>
(Instant AP) (DHCP Profile <profile-name>)# server-type <centralized>
(Instant AP) (DHCP Profile <profile-name>)# server-vlan <vlan-ID>
(Instant AP) (DHCP Profile <profile-name>)# option82 alu
(Instant AP) (DHCP Profile <profile-name>)# disable-split-tunnel
```

To configure a Centralized L3 DHCP profile:

```
(Instant AP) (config)# ip dhcp <profile-name>
(Instant AP) (DHCP Profile <profile-name>)# server-type <centralized>
(Instant AP) (DHCP Profile <profile-name>)# server-vlan <vlan-ID>
(Instant AP) (DHCP Profile <profile-name>)# dhcp-relay
(Instant AP) (DHCP Profile <profile-name>)# dhcp-server <DHCP-relay-server>
(Instant AP) (DHCP Profile <profile-name>)# vlan-ip <DHCP IP address> mask <VLAN mask>
```

Configuring the Default DHCP Scope for Client IP Assignment

The DHCP server is a built-in server, used for networks in which clients are assigned IP address by the virtual switch. You can customize the DHCP pool subnet and address range to provide simultaneous access to more number of clients. The largest address pool supported is 2048. The default size of the IP address pool is 512.

When a DHCP server is configured and if the **Client IP assignment** parameter for an SSID profile is set to **Virtual Controller Assigned**, the virtual switch assigns the IP addresses to the WLAN or the wired clients. By default, the OAW-IAP automatically determines a suitable DHCP pool for **Virtual Controller Assigned** networks.

OAW-IAPs typically select the 172.31.98.0/23 subnet. If the IP address of the OAW-IAP is within the 172.31.98.0/23 subnet, the OAW-IAP selects the 10.254.98.0/23 subnet. However, this mechanism does not guarantee that it would avoid all possible conflicts with the wired network. If your wired network uses either 172.31.98.0/23 or 10.254.98.0/23, and you experience problems with the **Virtual Controller Assigned** networks after upgrading to Alcatel-Lucent AOS-W Instant 6.2.1.0-3.4.0.0 or later, manually configure the DHCP pool by following the steps described in this section.



You can configure a domain name, DNS server, and DHCP server for client IP assignment using the WebUI or the CLI.

In the Old WebUI

To configure a DHCP pool:

1. Navigate to the **More > DHCP Server** tab.
2. Enter the domain name of the client in the **Domain name** text box.
3. Enter the IP addresses of the DNS servers separated by a comma (,) in the **DNS Server(s)** text box.
4. Enter the duration of the DHCP lease in the **Lease time** text box. Select any of the following values from the drop-down list next to **Lease time**:
 - **Minutes**—For minutes, specify a value between 2 and 59.
 - **Hours**—For hours, specify a value between 1 and 23.
 - **Days**—For days, specify a value between 1 and 30.

The default lease time is 0.

5. Enter the network range for the client IP addresses in the **Network** text box. The system generates a network range automatically that is sufficient for 254 addresses. If you want to provide simultaneous access to more number of clients, specify a larger range.
6. Specify the subnet mask details for the network range in the **Mask** text box.
7. Click **OK** to apply the changes.

In the New WebUI

To configure a DHCP pool:

1. Navigate to the **Configuration > DHCP Server** page.
2. Enter the domain name of the client in the **Domain name** text box.
3. Enter the IP addresses of the DNS servers separated by a comma (,) in the **DNS Server(s)** text box.
4. Enter the network range for the client IP addresses in the **Network** text box. The system generates a network range automatically that is sufficient for 254 addresses. If you want to provide simultaneous access to more number of clients, specify a larger range.
5. Specify the subnet mask details for the network range in the **Mask** text box.
6. Enter the duration of the DHCP lease in the **Lease time** text box. Select any of the following values from the drop-down list next to **Lease time**:
 - **Minutes**—For minutes, specify a value between 2 and 59.

- **Hours**—For hours, specify a value between 1 and 23.
- **Days** —For days, specify a value between 1 and 30.

The default lease time is 0.

7. Click **Save** to apply the changes.

In the CLI

To configure a DHCP pool:

```
(Instant AP) (config)# ip dhcp pool
(Instant AP) (DHCP)# domain-name <domain>
(Instant AP) (DHCP)# dns-server <DNS-IP-address>
(Instant AP) (DHCP)# lease-time <minutes>
(Instant AP) (DHCP)# subnet <IP-address>
(Instant AP) (DHCP)# subnet-mask <subnet-mask>
```

To view the DHCP database:

```
(Instant AP)# show ip dhcp database
```

This chapter describes time range profiles and the procedure for configuring time-based services. It includes the following topics:

- [Time Range Profiles on page 292](#)
- [Configuring a Time Range Profile on page 293](#)
- [Applying a Time Range Profile to a WLAN SSID on page 294](#)
- [Applying a Time Range Profile to a Role on page 295](#)
- [Verifying the Configuration on page 295](#)

Time Range Profiles

Starting from AOS-W Instant 6.4.3.4-4.2.1.0, OAW-IAPs allow you to enable or disable an SSID for users at a particular time of the day. You can now create a time range profile and assign it to a WLAN SSID, so that user access to the Internet or network is restricted during a specific time period.

OAW-IAPs support the configuration of both absolute and periodic time range profiles. You can configure an absolute time range profile to execute during a specific timeframe or create a periodic profile to execute at regular intervals based on the periodicity specified in the configuration.

The following configuration conditions apply to the time-based services:

- Time-based services require an active NTP server connection. OAW-IAPs use the default NTP server for time synchronization. However, the administrators can also configure an NTP server on the OAW-IAP. To verify the time synchronization between the NTP server and the OAW-IAP, execute the **show time-range** command and check if the time on the NTP server is in synchronization with the local time. For more information on NTP server configuration, see [NTP Server](#).
- For a time range profile configured to **enable** an SSID on the OAW-IAP:
 - When the timer starts, if the current time is greater than the start time and lesser than the end time, the SSID will be broadcast in the list of available networks by the AP. If an ACL rule is linked to the time profile, it is re-programmed and the rule which is time-based is applied. All the user sessions having this role assigned will be deleted.
 - When the timer ends, if the current time is greater than the end time, the SSID is disabled. If the SSID is already disabled, then there is no effect on the SSID.
 - If the SSID profile itself is disabled using the following configuration, then it will remain disabled and not be broadcast according to time range profile configuration.

```
(Instant AP) (SSID Profile "<profile_name>")# wlan ssid-profile <profile_name>
(Instant AP) (SSID Profile "<profile_name>")# disable
(Instant AP) (SSID Profile "<profile_name>")# time-range <profile_name> enable
```



In the above example, the time-range configuration will be accepted, but there will be no impact on the SSID and will continue to remain disabled.

- For a time range profile configured to **disable** an SSID on the OAW-IAP:
 - When the timer starts, if the current time is greater than the start time and lesser than the end time, the SSID will not be broadcast by the AP in the list of available networks. If an ACL rule is linked to the time profile, it is re-programmed and the rule which is time-based is not applied. All the user sessions having this role assigned will be deleted.

- When the timer ends, if the current time is greater than the end time, the SSID is broadcast by the AP. If the SSID is already enabled, then there is no effect on the SSID.
- The enable and disable time-range profiles cannot be applied to an SSID profile at the same time.
- If an SSID has two time range profiles configured with an overlapping duration, the overlapping time range is rejected by the AP.

Configuring a Time Range Profile

You can create time range profiles using the WebUI or the CLI.

In the Old WebUI

To create a time range profile:

1. Navigate to **System > Show advanced options > Time Based Services**.
2. Click **New** under **Time Range Profiles**. The **New profile** window for creating time range profiles is displayed.
3. Configure the parameters listed in the following table:

Table 70: Time Range Profile Configuration Parameters

Parameter	Description
Name	Specify a name for the time range profile.
Type	Select the type of time range profile. Periodic —When configured, the state of the OAW-IAP changes based on the time range configured in the profile. Absolute —When configured, the state of the OAW-IAP changes during a specific date, day, and time.
Period type	For periodic time range profiles, specify a periodic interval (day, weekday, weekend, or daily) at which the time range profile must be applied.
Start Day and End Day	For absolute time range profiles, specify the start day and the end day to configure a specific time period during which the time range profile is applied. NOTE: Ensure that the year selected for Start Day and End Day cannot exceed 2037.
Start Time	Select the start time for the time range profile in the hh:mm format.
End Time	Select the end time for the time range profile in hh:mm format.

4. Click **OK**.
5. Click **OK** in the **System** window.

In the New WebUI

To create a time range profile:

1. Navigate to **Configuration > System** page.
2. Click **Show advanced options** at the bottom of the window.
3. Expand **Time Based Services**.
4. Click **+** under **Time Range Profiles**.
5. Configure the parameters listed in the following table:

Table 71: Time Range Profile Configuration Parameters

Parameter	Description
Name	Specify a name for the time range profile.
Type	Select the type of time range profile. Periodic —When configured, the state of the OAW-IAP changes based on the time range configured in the profile. Specify a periodic interval (day, weekday, weekend, or daily) at which the time range profile must be applied. Absolute —When configured, the state of the OAW-IAP changes during a specific date, day, and time.
Start Day and End Day	For absolute time range profiles, specify the start day and the end day to configure a specific time period during which the time range profile is applied. NOTE: Ensure that the year selected for Start Day and End Day cannot exceed 2037.
Start Time	Select the start time for the time range profile in the hh:mm format.
End Time	Select the end time for the time range profile in hh:mm format.

6. Click **OK**.
7. Click **Save**.

In the CLI:

To create an absolute time range profile:

```
(Instant AP) (config)# time-range <name> absolute start <startday> <starttime> end <endday> <endtime>
```

To configure a periodic time range profile:

```
(Instant AP) (config)# time-range <name> periodic {<startday>|daily|weekday|weekend} <starttime> to <endtime>
```

Applying a Time Range Profile to a WLAN SSID

You can apply a time range profile to a WLAN SSID using the WebUI.

In the Old WebUI

Applying a time range profile:

1. Navigate to the WLAN SSID profile configuration wizard.
 - a. Click **Networks > New** or
 - b. Select an existing WLAN SSID and click **edit**.
2. Click **Show advanced options**.
3. In the **Time Range** section, click the **Edit** link, select a time range profile from the list, then select a value from the **Status** drop-down list, and then click **OK**.
 - When a time range profile is enabled on an SSID, the SSID is made available to the users for the configured time range. For example, if the specified time range is 12:00–13:00, the SSID becomes available only between 12 PM and 1 PM on a given day.
 - If a time range is disabled, the SSID becomes unavailable for the configured time range. For example, if the configured time range is 14:00–17:00, the SSID is made unavailable from 2 PM to 5 PM on a given day.
4. Click **Next** in the **WLAN Settings**, **VLAN**, and **Security** tabs and then click **Finish** in the **Access** tab.

In the New WebUI

Applying a time range profile:

1. Navigate to the WLAN SSID profile configuration wizard.
 - a. Go to **Configuration > Networks**.
 - b. Click **+** to add a new profile or select an existing WLAN SSID profile and click **Edit**.
2. Click **Show advanced options** at the bottom of the page.
3. In the **Time Range** section, click **Edit** for **Time Range Profiles**, select a time range profile from the list, then select a value from the **Status** drop-down list, and then click **OK**.
 - When a time range profile is enabled on an SSID, the SSID is made available to the users for the configured time range. For example, if the specified time range is 12:00–13:00, the SSID becomes available only between 12 PM and 1 PM on a given day.
 - If a time range is disabled, the SSID becomes unavailable for the configured time range. For example, if the configured time range is 14:00–17:00, the SSID is made unavailable from 2 PM to 5 PM on a given day.
4. Click **Next** until **Finish**.

In the CLI

To enable an SSID during a specific time-range:

```
(Instant AP) (config)# wlan ssid-profile <profile_name>
(Instant AP) (SSID Profile "<name>")# time-range <profile_name> enable
```

To disable an SSID during a specific time-range:

```
(Instant AP) (config)# wlan ssid-profile <profile_name>
(Instant AP) (SSID Profile "<name>")# time-range <profile_name> disable
```

Verifying the Configuration

To view the time range profiles created on an OAW-IAP:

```
(Instant AP) # show time-range
```

To view the list of time range profiles configured on an OAW-IAP:

```
(Instant AP)# show time-profile
```

Applying a Time Range Profile to a Role

You can apply a time range profile to a rule using the WebUI.

In the Old WebUI

Applying a time range profile:

1. Navigate to **Security > Roles**.
 - a. Click **Roles > New** and create a new role or
 - b. Select an existing role under **Roles** and click **Access Rules for <Role> > New**.
2. Select **Time Range** and select a time range from the drop-down list.
3. Click **OK**.
 - When a time range profile is enabled on a role, the role is made available to the users for the configured time range. For example, if the specified time range is 12:00–13:00, the role becomes available only between 12 PM and 1 PM on a given day.

- If a time range is disabled, the role becomes unavailable for the configured time range. For example, if the configured time range is 14:00–17:00, the role is made unavailable from 2 PM to 5 PM on a given day.

In the New WebUI

Applying a time range profile:

1. Navigate to **Configuration > Security > Roles**.
 - a. Click **Roles > +** and create a new role or
 - b. Select an existing role under **Roles** and click **Access Rules for <Role> > New**.
2. Select **Time Range** and select a time range from the drop-down list.
3. Click **OK**.
 - When a time range profile is enabled on a role, the role is made available to the users for the configured time range. For example, if the specified time range is 12:00–13:00, the role becomes available only between 12 PM and 1 PM on a given day.
 - If a time range is disabled, the role becomes unavailable for the configured time range. For example, if the configured time range is 14:00–17:00, the role is made unavailable from 2 PM to 5 PM on a given day.

In the CLI

To enable a role during a specific time-range:

```
(Instant AP) (config)# wlan access-rule <profile_name>
(Instant AP) (SSID Profile "<name>")# rule ... time-range <profile_name>
```

To disable a role during a specific time-range:

```
(Instant AP) (config)# wlan access-rule <profile_name>
(Instant AP) (SSID Profile "<name>")# no rule ... time-range <profile_name>
```

This chapter describes the following VPN configuration procedures:

- [Understanding VPN Features on page 297](#)
- [Configuring a Tunnel from an OAW-IAP to an OmniAccess Mobility Controller on page 299](#)
- [Configuring Routing Profiles on page 305](#)

Understanding VPN Features

As OAW-IAPs use a virtual switch architecture, the OAW-IAP network does not require a physical switch to provide the configured WLAN services. However, a physical switch is required for terminating VPN tunnels from the OAW-IAP networks at branch locations to data centers, where the Alcatel-Lucent switch acts as a VPN concentrator.

When a VPN is configured, the OAW-IAP acting as the virtual switch creates a VPN tunnel to an OmniAccess Mobility Controller in your corporate office. The switch acts as a VPN endpoint and does not supply the OAW-IAP with any configuration.

The VPN features are recommended for the following setups:

- Enterprises with many branches that do not have a dedicated VPN connection to the corporate office.
- Branch offices that require multiple OAW-IAPs.
- Individuals working from home and, connecting to the VPN.

The survivability feature of OAW-IAPs with the VPN connectivity of OAW-RAPs allows you to provide corporate connectivity on non-corporate networks.

Supported VPN Protocols

AOS-W Instant supports the following VPN protocols for remote access:

Table 72: VPN Protocols

VPN Protocol	Description
Alcatel-Lucent IPsec	<p>IPsec is a protocol suite that secures IP communications by authenticating and encrypting each IP packet of a communication session.</p> <p>You can configure an IPsec tunnel to ensure that the data flow between the networks is encrypted. However, you can configure a split-tunnel to encrypt only the corporate traffic. When IPsec is configured, ensure that you add the OAW-IAP MAC addresses to the whitelist database stored on the switch or an external server. IPsec supports Local, L2, and L3 modes of IAP-VPN operations.</p> <p>NOTE: The OAW-IAPs support IPsec only with Alcatel-Lucent switches.</p>
Layer-2 GRE	<p>GRE is a tunnel protocol for encapsulating multicast, broadcast, and L2 packets between a GRE-capable device and an endpoint. OAW-IAPs support the configuration of L2 GRE tunnel with an Alcatel-Lucent switch to encapsulate the packets sent and received by the OAW-IAP.</p> <p>You can use the GRE configuration for L2 deployments when there is no encryption requirement between the OAW-IAP and switch for client traffic.</p> <p>OAW-IAPs support two types of GRE configuration:</p> <ul style="list-style-type: none">■ Manual GRE—The manual GRE configuration sends unencrypted client traffic with an additional GRE header and does not support failover. When manual GRE is configured on the OAW-IAP, ensure that the GRE tunnel settings are enabled on the switch.■ Aruba GRE—With Aruba GRE, no configuration on the switch is required except for adding the OAW-IAP MAC addresses to the whitelist database stored on the switch or an external server. Aruba GRE reduces manual configuration when Per-AP tunnel configuration is required and supports failover between two GRE endpoints. <p>NOTE: OAW-IAPs support manual and Aruba GRE configuration only for L2 mode of operations. Aruba GRE configuration is supported only on Alcatel-Lucent switches.</p>

Diffie-Hellman Algorithm

Diffie-Hellman is a key agreement algorithm that allows two parties to agree upon a shared secret, and is used within IKE to securely establish session keys.

AOS-W Instant supports the following Diffie-Hellman groups:

- Group 2: 1024-bit Diffie-Hellman prime modulus group
- Group 14: 2048-bit Diffie-Hellman prime modulus group

By default, OAW-IAPs attempt to use Diffie-Hellman Group 2 to set up an IAP VPN connection. If the switch rejects Diffie-Hellman Group 2, the OAW-IAPs can use Diffie-Hellman Group 14.



Diffie-Hellman Group 2 is not permitted if FIPS mode is enabled on an OAW-IAP.

Enabling Cipher Algorithms

Starting from AOS-W Instant 8.4.0.0, you can configure the following ciphers based on your preference, to establish an SSH connection with the OAW-IAP:

- AES-CBC
- AES-CTR



You cannot disable both the ciphers together. At any given point in time, either one of both the ciphers will be enabled.

By default, these ciphers are enabled. You can configure the ciphers by using the CLI.

In the CLI

The following command enables AES-CBC and disables AES-CTR on the SSH server:

```
(Instant AP) (config) #ssh disable-ciphers aes-ctr
```

The following command enables the disabled cipher encryptions on the SSH server:

```
(Instant AP) (config) #no ssh disable-ciphers
```

The following command displays the SSH configuration details:

```
(Instant AP) #show ssh
```

Configuring a Tunnel from an OAW-IAP to an OmniAccess Mobility Controller

OAW-IAP supports the configuration of tunneling protocols such as GRE and IPsec. This section describes the procedure for configuring VPN host settings on an OAW-IAP to enable communication with a switch in a remote location:

- [Configuring an IPsec Tunnel on page 299](#)
- [Configuring an L2-GRE Tunnel on page 301](#)

Configuring an IPsec Tunnel

An IPsec tunnel is configured to ensure that the data flow between the networks is encrypted. When configured, the IPsec tunnel to the switch secures corporate data.

You can configure an IPsec tunnel from the virtual switch using the WebUI or the CLI.

In the Old WebUI

To configure a tunnel for IPsec protocol:

1. Go to **More > Tunneling**.
2. Select **Aruba IPsec** from the **Protocol** drop-down list.
3. Enter the IP address or FQDN for the primary VPN or IPsec endpoint in the **Primary host** text box.
4. Enter the IP address or FQDN for the backup VPN or IPsec endpoint in the **Backup host** text box. This entry is optional. When you specify the primary and backup host details, the following details are displayed:
 - a. To allow the VPN tunnel to switch back to the primary host when it becomes available again, select **Enabled** from the **Preemption** drop-down list. This step is optional.
 - b. If **Preemption** is enabled, specify a value in seconds for **Hold time**. When preemption is enabled and the primary host comes up, the VPN tunnel switches back to the primary host after the specified hold-time. The default value for **Hold time** is 600 seconds.
 - c. To allow the OAW-IAP to create a backup VPN tunnel to the switch along with the primary tunnel, and maintain both the primary and backup tunnels separately, select **Enabled** from the **Fast failover** drop-down list. When fast failover is enabled and if the primary tunnel fails, the OAW-IAP can switch the data stream to the backup tunnel. This reduces the total failover time to less than one minute.
 - d. To disconnect all wired and wireless users when the system switches during VPN tunnel transition from primary to backup and backup to primary, set **Reconnect User On Failover** to **Enabled**.
 - e. To configure an interval during which the wired and wireless users are disconnected during a VPN tunnel switch, specify a value in seconds for **Reconnect Time On Failover** within a range of 30–900 seconds. By default, the reconnection duration is set to 60 seconds.
5. Specify the following parameters:

- a. Specify a value in seconds for **Secs between test packets**. Based on the configured frequency, the OAW-IAP can verify if an active VPN connection is available. The default value is 5 seconds, which means that the OAW-IAP sends one packet to the switch every 5 seconds.
 - b. Enter a value for **Max allowed test packet loss** to define a number for lost packets, exceeding which the OAW-IAP can determine that the VPN connection is unavailable. The default value is 2.
6. Click **Next** to create routing profiles. When the IPsec tunnel configuration is completed, the packets that are sent from and received by an OAW-IAP are encrypted.
 7. Click **Finish**.

In the New WebUI

To configure a tunnel for IPsec protocol:

1. Go to the **Configuration > Tunneling** page.
2. Under **Controller**, select **Aruba IPsec** from the **Protocol** drop-down list.
3. Enter the IP address or FQDN for the primary VPN or IPsec endpoint in the **Primary host** text box.
4. Enter the IP address or FQDN for the backup VPN or IPsec endpoint in the **Backup host** text box. This entry is optional. When you specify the primary and backup host details, the following details are displayed:
 - c. To allow the VPN tunnel to switch back to the primary host when it becomes available again, click the **Preemption** toggle switch. This step is optional.
 - d. If **Preemption** is enabled, specify a value in seconds for **Hold time**. When preemption is enabled and the primary host comes up, the VPN tunnel switches back to the primary host after the specified hold-time. The default value for **Hold time** is 600 seconds.
 - e. To allow the OAW-IAP to create a backup VPN tunnel to the switch along with the primary tunnel, and maintain both the primary and backup tunnels separately, toggle the **Fast failover** switch. When fast failover is enabled and if the primary tunnel fails, the OAW-IAP can switch the data stream to the backup tunnel. This reduces the total failover time to less than one minute.
 - f. To disconnect all wired and wireless users when the system switches during VPN tunnel transition from primary to backup and backup to primary, toggle the **Reconnect User On Failover** switch.
 - g. To configure an interval during which the wired and wireless users are disconnected during a VPN tunnel switch, specify a value in seconds for **Reconnect Time On Failover** within a range of 30–900 seconds. By default, the reconnection duration is set to 60 seconds.
5. Specify the following parameters:
 - a. Specify a value in seconds for **Secs between test packets**. Based on the configured frequency, the OAW-IAP can verify if an active VPN connection is available. The default value is 5 seconds, which means that the OAW-IAP sends one packet to the switch every 5 seconds.
 - b. Enter a value for **Max allowed test packet loss** to define a number for lost packets, exceeding which the OAW-IAP can determine that the VPN connection is unavailable. The default value is 2.
6. Click **Save**.

In the CLI

To configure an IPsec VPN tunnel:

```
(Instant AP) (config)# vpn primary <name>
(Instant AP) (config)# vpn backup <name>
(Instant AP) (config)# vpn fast-failover
(Instant AP) (config)# vpn hold-time <seconds>
(Instant AP) (config)# vpn preemption
(Instant AP) (config)# vpn monitor-pkt-send-freq <frequency>
(Instant AP) (config)# vpn monitor-pkt-lost-cnt <count>
(Instant AP) (config)# vpn reconnect-user-on-failover
(Instant AP) (config)# vpn reconnect-time-on-failover <down_time>
```

Example

```
(Instant AP) (config)# vpn primary 192.0.2.18
(Instant AP) (config)# vpn backup 192.0.2.20
(Instant AP) (config)# vpn fast-failover
(Instant AP) (config)# vpn preemption

(Instant AP) (config)# ip dhcp distl2
(Instant AP) (DHCP Profile "distL2")# server-type Distributed,L2
(Instant AP) (DHCP Profile "distL2")# server-vlan 2
(Instant AP) (DHCP Profile "distL2")# ip-range 10.15.205.0 10.15.205.255
(Instant AP) (DHCP Profile "distL2")# subnet-mask 255.255.255.0
(Instant AP) (DHCP Profile "distL2")# lease-time 86400
(Instant AP) (DHCP Profile "distL2")# default-router 10.15.205.254
(Instant AP) (DHCP Profile "distL2")# dns-server 10.13.6.110,10.1.1.50
(Instant AP) (DHCP Profile "distL2")# domain-name alcatel-lucent.com
(Instant AP) (DHCP Profile "distL2")# client-count 5

(Instant AP) (config)# ip dhcp local
(Instant AP) (DHCP Profile "local")# server-type Local
(Instant AP) (DHCP Profile "local")# server-vlan 200
(Instant AP) (DHCP Profile "local")# subnet 172.16.200.1
(Instant AP) (DHCP Profile "local")# subnet-mask 255.255.255.0
(Instant AP) (DHCP Profile "local")# lease-time 86400
(Instant AP) (DHCP Profile "local")# dns-server 10.13.6.110,10.1.1.50
(Instant AP) (DHCP Profile "local")# domain-name alcatel-lucent.com
```

To view the VPN configuration:

```
(Instant AP)# show vpn config
```

Configuring an L2-GRE Tunnel

This section describes the following procedures:

- [Configuring Manual GRE Parameters](#)
- [Configuring Aruba GRE Parameters](#)

Configuring Manual GRE Parameters

You can configure a GRE tunnel between the OAW-IAP and the switch using either the virtual switch IP or the OAW-IAP IP, based on the following OAW-IAP settings:

- If a virtual switch IP is configured and if **Per-AP tunnel** is disabled, use virtual switch IP.
- If a virtual switch IP is not configured or if **Per-AP tunnel** is enabled, use the OAW-IAP IP.

For information on the GRE tunnel configuration on the switch, refer to the *AOS-W User Guide*.

In the Old WebUI

To configure a GRE tunnel:

1. Go to **More > Tunneling**.
2. Select **Manual GRE** from the **Protocol** drop-down list.
3. Specify the following parameters:
 - a. Enter an IP address or an FQDN for the main VPN or GRE endpoint in the **Primary host** text box.
 - b. Enter a value in the **GRE type** text box.
 - c. Select **Enabled** or **Disabled** from the **Per-AP tunnel** drop-down list. Enable this option to create a GRE tunnel from each OAW-IAP to the VPN or GRE endpoint rather than the tunnels created just from the master OAW-IAP. When enabled, the traffic to the corporate network is sent through a Layer-2 GRE tunnel from the OAW-IAP itself and need not be forwarded through the master OAW-IAP.



By default, the **Per-AP tunnel** option is disabled.

4. Click **Next** to continue. When the GRE tunnel configuration is completed on both the OAW-IAP and the switch, the packets sent from and received by an OAW-IAP are encapsulated, but not encrypted.
5. Click **Finish**.

In the New WebUI

To configure a GRE tunnel:

1. Go to the **Configuration > Tunneling** page.
2. Expand the **Controller** section, select **Manual GRE** from the **Protocol** drop-down list.
3. Specify the following parameters:
 - a. Enter an IP address or an FQDN for the main VPN or GRE endpoint in the **Primary host** text box.
 - b. Enter a value in the **GRE type** text box.
 - c. Toggle the **Per-AP tunnel** switch to create a GRE tunnel from each OAW-IAP to the VPN or GRE endpoint rather than the tunnels created just from the master OAW-IAP. When enabled, the traffic to the corporate network is sent through a Layer-2 GRE tunnel from the OAW-IAP itself and need not be forwarded through the master OAW-IAP. By default, this parameter is disabled.
4. Click **Save**.

In the CLI

To configure a manual GRE VPN tunnel:

```
(Instant AP) (config)# gre primary <name>
(Instant AP) (config)# gre type <type>
(Instant AP) (config)# gre per-ap-tunnel
```

To view VPN configuration details:

```
(Instant AP)# show vpn config
```

To configure GRE tunnel on the switch:

```
(Instant AP) (config)# interface tunnel <Number>
(Instant AP) (config-tunnel)# description <Description>
(Instant AP) (config-tunnel)# tunnel mode gre <ID>
(Instant AP) (config-tunnel)# tunnel source <controller-IP>
(Instant AP) (config-tunnel)# tunnel destination <AP-IP>
(Instant AP) (config-tunnel)# trusted
(Instant AP) (config-tunnel)# tunnel vlan <allowed-VLAN>
```

Configuring Aruba GRE Parameters

The Aruba GRE feature uses the IPsec connection between the OAW-IAP and the switch to send the control information for setting up a GRE tunnel. When Aruba GRE configuration is enabled, a single IPsec tunnel between the OAW-IAP cluster and the switch, and one or several GRE tunnels are created based on the Per-AP tunnel configuration on the OAW-IAP. For Aruba GRE, no manual configuration is required on the switch to create the GRE tunnel.

Aruba GRE is supported on Alcatel-Lucent switches running AOS-W 6.4.x.x or later versions.



OAW-IAPs can send IPsec and GRE heartbeat packets to Alcatel-Lucent switches. By default, OAW-IAPs verify the status of heartbeat messages every 5 seconds, and look for lost packets 6 times before marking down the IPsec tunnel. However, these time intervals can be modified.

In the Old WebUI

To configure Aruba GRE:

1. Go to **More > Tunneling**.
2. Select **Aruba GRE** from the **Protocol** drop-down list.
3. Enter the IP address or the FQDN for the main VPN or IPsec endpoint in the **Primary host** text box.
4. Enter the IP address or the FQDN for the backup VPN or IPsec endpoint in the **Backup host** text box. This entry is optional. When you enter the primary host IP address and backup host IP address, the following details are displayed:
 - a. To allow the VPN tunnel to switch back to the primary host when it becomes available again, select **Enabled** from the **Preemption** drop-down list. This step is optional.
 - b. If **Preemption** is enabled, specify a value in seconds for **Hold time**. When preemption is enabled and the primary host comes up, the VPN tunnel switches to the primary host after the specified hold time. The default value for **Hold time** is 600 seconds.
 - c. To allow the OAW-IAP to create a backup VPN tunnel to the switch along with the primary tunnel, and maintain both the primary and backup tunnels separately, select **Enabled** from the **Fast failover** drop-down list. If this option is enabled, when the primary tunnel fails, the OAW-IAP can switch the data stream to the backup tunnel. This reduces the total failover time to less than one minute.
 - d. To disconnect all wired and wireless users when the system switches during VPN tunnel transition from primary to backup and backup to primary, set **Reconnect User on Failover** to **Enabled**.
 - e. To configure an interval for which wired and wireless users are disconnected during a VPN tunnel switch, specify a value in seconds for **Reconnect Time on Failover** within the range of 30–900 seconds. By default, the reconnection duration is set to 60 seconds.
5. Specify the following parameters:
 - a. Specify a value in seconds for **Secs between test packets**. Based on the configured frequency, the OAW-IAP can verify if an active VPN connection is available. The default value is 5 seconds, which means that the OAW-IAP sends one packet to the switch every 5 seconds.
 - b. Enter a value for **Max allowed test packet loss** to define a number for lost packets, exceeding which the OAW-IAP can determine that the VPN connection is unavailable. The default value is 2.
 - c. Select **Enabled** or **Disabled** from the **Per-AP tunnel** drop-down list. The administrator can enable this option to create a GRE tunnel from each OAW-IAP to the VPN or GRE endpoint rather than the tunnels created just from the master OAW-IAP. When enabled, the traffic to the corporate network is sent through a Layer-2 GRE tunnel from the OAW-IAP itself and need not be forwarded through the master OAW-IAP.
6. Click **Next**.
7. Click **Finish**.

In the New WebUI

To configure Aruba GRE:

1. Go to the **Configuration > Tunneling** page.
2. Expand **Controller**.
3. Select **Aruba GRE** from the **Protocol** drop-down list.
4. Enter the IP address or the FQDN for the main VPN or IPsec endpoint in the **Primary host** text box.
5. Enter the IP address or the FQDN for the backup VPN or IPsec endpoint in the **Backup host** text box. This entry is optional. When you enter the primary host IP address and backup host IP address, the following details are displayed:

- a. To allow the VPN tunnel to switch back to the primary host when it becomes available again, click the **Preemption** toggle switch. This step is optional.
 - b. If **Preemption** is enabled, specify a value in seconds for **Hold time**. When preemption is enabled and the primary host comes up, the VPN tunnel switches to the primary host after the specified hold time. The default value for **Hold time** is 600 seconds.
 - c. To allow the OAW-IAP to create a backup VPN tunnel to the switch along with the primary tunnel, and maintain both the primary and backup tunnels separately, toggle the **Fast failover** switch. If this option is enabled, when the primary tunnel fails, the OAW-IAP can switch the data stream to the backup tunnel. This reduces the total failover time to less than one minute.
 - d. To disconnect all wired and wireless users when the system switches during VPN tunnel transition from primary to backup and backup to primary, toggle the **Reconnect User on Failover** switch.
 - e. To configure an interval for which wired and wireless users are disconnected during a VPN tunnel switch, specify a value in seconds for **Reconnect Time on Failover** within the range of 30–900 seconds. By default, the reconnection duration is set to 60 seconds.
6. Specify the following parameters:
- a. Specify a value in seconds for **Secs between test packets**. Based on the configured frequency, the OAW-IAP can verify if an active VPN connection is available. The default value is 5 seconds, which means that the OAW-IAP sends one packet to the switch every 5 seconds.
 - b. Specify a value for **Max allowed test packet loss** to define a number for lost packets, exceeding which the OAW-IAP can determine that the VPN connection is unavailable. The default value is 2.
 - c. Enable or disable the **Per-AP tunnel** toggle switch as required. The administrator can enable this option to create a GRE tunnel from each OAW-IAP to the VPN or GRE endpoint rather than the tunnels created just from the master OAW-IAP. When enabled, the traffic to the corporate network is sent through a Layer-2 GRE tunnel from the OAW-IAP itself and need not be forwarded through the master OAW-IAP.
7. Click **Save**.

In the CLI

To enable Aruba GRE tunnel:

```
(Instant AP) (config)# vpn gre-outside
(Instant AP) (config)# vpn primary <name/IP-address>
(Instant AP) (config)# vpn backup <<name/IP-address>>
(Instant AP) (config)# vpn fast-failover
(Instant AP) (config)# vpn hold-time <seconds>
(Instant AP) (config)# vpn preemption
(Instant AP) (config)# vpn monitor-pkt-send-freq <frequency>
(Instant AP) (config)# vpn monitor-pkt-lost-cnt <count>
(Instant AP) (config)# vpn reconnect-user-on-failover
(Instant AP) (config)# vpn reconnect-time-on-failover <down_time>
```

To view VPN configuration details:

```
(Instant AP)# show vpn config
```

Support for IAP-VPN Termination on Mobility Controller Virtual Appliance

Starting from Alcatel-Lucent AOS-W Instant 8.3.0.0, IAP-VPN is supported on Mobility Controller Virtual Appliance by using default self-signed certificate (Aruba PKI). For OAW-IAP to establish IPsec connection with Mobility Controller Virtual Appliance, the switch presents a default self-signed certificate which is uploaded on the OAW-IAP using Activate.



Mobility Masters (Mobility Master Hardware Appliance, Mobility Master Virtual Appliance, and Master switch Mode)

do not support any AP termination including Campus APs, Remote APs and IAP-VPN tunnels.

Through Activate, you can push only one default self-signed certificate to OAW-IAP which can be used to establish IPsec tunnel with Mobility Controller Virtual Appliance.

VPN features are ideal for:

- enterprises with many branches that do not have a dedicated VPN connection to the Head Quarter.
- branch offices that require multiple APs.
- individuals working from home, connecting to the VPN.

This new architecture and form factor seamlessly adds the survivability feature of Instant APs with the VPN connectivity of RAPs — providing corporate connectivity to branches.

Configuring Multiple Active Tunnels

Starting from Alcatel-Lucent AOS-W Instant 8.4.0.0, you can configure multiple active VPN tunnels on an OAW-IAP. You can configure up to four pairs of Primary and Backup VPN tunnels. Only one IPsec tunnel can be selected for each VPN primary and backup pair and a default VPN tunnel must be configured if you wish to keep more than one active VPN tunnel to pass Centralized, L2 traffic.

Configuring Routing Profiles

OAW-IAPs can terminate a single VPN connection on an OmniAccess Mobility Controller. The routing profile defines the corporate subnets which need to be tunneled through IPsec. You can configure routing profiles for policy based routing into the VPN tunnel using the WebUI or the CLI.

In the Old WebUI

To configure a routing profile:

1. Go to **More > Routing**. The **Routing** window is displayed.
2. Click **New**. The **Route** window is displayed.
3. Update the following parameters:
 - **Destination**— Specify the destination network that is reachable through the VPN tunnel. This defines the IP or subnet that must reach through the IPsec tunnel. Traffic to the IP or subnet defined here will be forwarded through the IPsec tunnel.
 - **Netmask**—Specify the subnet mask to the destination.
 - **Gateway**—Specify the gateway to which the traffic must be routed. This IP address must be the switch IP address on which the VPN connection is terminated. If you have a primary and backup host, configure two routes with the same destination and netmask, but ensure that the gateway is the primary switch IP for one route and the backup switch IP for the second route.
 - **Metric**—The default metric value is 15. Specify a metric value for the datapath route. When two routes or more routes with the same network destination are available for data forwarding, the route with the least metric value takes preference.
4. Repeat step 3 to create the required number of routing profiles.
5. Click **OK** in **Route** and then click **OK** in **Routing**.

In the New WebUI

To configure a routing profile:

1. Navigate to the **Configuration > Routing** page.
2. In the **Routing** table, click **+**.

3. Update the following parameters:

- **Destination**— Specify the destination network that is reachable through the VPN tunnel. This defines the IP or subnet that must reach through the IPsec tunnel. Traffic to the IP or subnet defined here will be forwarded through the IPsec tunnel.
- **Netmask**—Specify the subnet mask to the destination.
- **Gateway**—Specify the gateway to which the traffic must be routed. This IP address must be the switch IP address on which the VPN connection is terminated. If you have a primary and backup host, configure two routes with the same destination and netmask, but ensure that the gateway is the primary switch IP for one route and the backup switch IP for the second route.
- **Metric**—The default metric value is 15. Specify a metric value for the datapath route. When two routes or more routes with the same network destination are available for data forwarding, the route with the least metric value takes preference.

4. Repeat steps 2 and 3 to create the required number of routing profiles.

5. Click **OK**.

6. Click **Save**.

In the CLI

```
(Instant AP) (config)# routing-profile  
(Instant AP) (Routing-profile)# route <destination> <mask> <gateway> {<metric>}
```



Routing profile is primarily used for IAP-VPN scenarios, to control which traffic should flow between the master OAW-IAP and the VPN tunnel, and which traffic should flow outside of the tunnel.

This chapter describes the procedure for configuring Dynamic DNS on OAW-IAPs and their Distributed, L3 clients. It includes the following topics:

- [Enabling Dynamic DNS on page 307](#)
- [Configuring Dynamic DNS Updates for Clients on page 309](#)
- [Verifying the Configuration on page 310](#)

Enabling Dynamic DNS

Starting from AOS-W Instant 6.4.4.4-4.2.3.0, AOS-W Instant APs support the dynamic DNS feature which enables updating the host name of the AOS-W Instant AP and the DL3 clients connected to it. In a scenario where the public IP address is dynamically handed to the AOS-W Instant AP by the ISP, the connectivity to the AOS-W Instant AP is lost when there is a change in the public IP address. Similarly, in case of DL3 clients, where the AOS-W Instant AP acts as a DHCP server, the host becomes unreachable when the dynamically assigned IP address is changed. The dynamic DNS feature eliminates these issues by configuring a host name, thus providing a uniform approach to access the AOS-W Instant AP and the DL3 clients. The IP address of the AOS-W Instant AP and the DL3 client is mapped to the host name and this gets automatically updated to the DNS server each time the IP address is changed.

You can enable Dynamic DNS using the WebUI or the CLI.

In the Old WebUI

To enable dynamic DNS:

1. Navigate to **More > Services > Dynamic DNS**.
2. Select the **Enable Dynamic DNS** check box.

Table 73: Dynamic DNS Configuration Parameters

Parameter	Description	Example
Key	<p>Configures a Transaction Signature shared secret key to secure the dynamic updates.</p> <p>The following algorithm names are supported:</p> <ul style="list-style-type: none">■ hmac-md5 (used by default if algo-name is not specified)■ hmac-sha1■ hmac-sha256 <p>NOTE: When the Key value is configured, the update is successful only if the OAW-IAP and the DNS server clocks are in sync.</p>	<code>hmac-sha1:arubaddns: 16YuLPdH21rQ6PuK9udsVLTJw3Y=</code>
Server IP	<p>Enter the server IP address of the DNS server to which the client updates are sent.</p> <p>NOTE: If the DNS server IP address is not specified in the Dynamic DNS window, the OAW-IAP's updates will be sent to the OAW-IAP's DNS server instead.</p>	<code>10.17.132.85</code>
Interval	<p>Specify the time interval (in seconds) at which the DNS updates are to be synced to the server. The default time interval is 12 hours, minimum time interval is 15 minutes, and maximum time interval is 100 days.</p>	<code>900</code>

3. Click **OK**.

In the New WebUI

To enable dynamic DNS:

1. Navigate to the **Configuration > Services** page.
2. Expand **Dynamic DNS**.
3. Toggle the **Enable Dynamic DNS** switch to enable.

Table 74: Dynamic DNS Configuration Parameters

Parameter	Description	Example
Key	Configures a Transaction Signature shared secret key to secure the dynamic updates. The following algorithm names are supported: <ul style="list-style-type: none"> ■ hmac-md5 (used by default if algo-name is not specified) ■ hmac-sha1 ■ hmac-sha256 NOTE: When the Key value is configured, the update is successful only if the OAW-IAP and the DNS server clocks are in sync.	hmac-sha1:arubaddns: 16YuLPdH21rQ6PuK9udsVLTJw3Y=
Server IP	Enter the server IP address of the DNS server to which the client updates are sent. NOTE: If the DNS server IP address is not specified in the Dynamic DNS window, the OAW-IAP's updates will be sent to the OAW-IAP's DNS server instead.	10.17.132.85
Interval	Specify the time interval (in seconds) at which the DNS updates are to be synced to the server. The default time interval is 12 hours, minimum time interval is 15 minutes, and maximum time interval is 100 days.	900

4. Click **Save**.

In the CLI:

To enable dynamic DNS on an OAW-IAP

```
(Instant AP) (config)# dynamic-dns-ap
```

To configure a TSIG key and server IP address:

```
(Instant AP) (config)# dynamic-dns-ap key <algo-name:keyname:keystring>
```

```
(Instant AP) (config)# dynamic-dns-ap server <ddns_server>
```

To configure a time interval:

```
(Instant AP) (config)# dynamic-dns-interval <ddns_interval>
```

Configuring Dynamic DNS Updates for Clients

You can enable DDNS updates when creating or editing a DHCP scope for **Distributed, L3** clients. When enabled, the DDNS updates of the clients are periodically sent during the specified time to the DNS server that is configured in the DHCP profile. For the DL3 clients, if the DNS server IP is not configured in the DHCP profile, the client updates will be dropped. The DDNS updates are secured by using TSIG shared secret keys, when communicating between the client and the server. For more information, refer to [Enabling Dynamic DNS on page 307](#) and [Configuring Distributed DHCP Scopes on page 280](#).

In the Old WebUI

To enable DDNS for clients:

1. Navigate to **More > DHCP Server**, select the distributed L3 DHCP Scope under **Distributed DHCP Scopes** and click **Edit**.
2. Select the **Dynamic DNS** check box.
3. Enter the TSIG shared secret **key**.

4. Click **Next** and then click **Finish**.

In the New WebUI

To enable DDNS for clients:

1. Navigate to the **Configuration > DHCP Server** page.
2. Select the distributed L3 DHCP Scope under **Distributed DHCP Scopes** to modify a DHCP scope.
3. Toggle the **Dynamic DNS** switch to enable.
4. In the **Key** text box, enter the TSIG shared secret key.
5. Click **Next** until **Finish**.

In the CLI

To enable DDNS for OAW-IAP clients:

```
(Instant AP) (config)# ip dhcp <profile name>
(Instant AP) (DHCP profile "<name>")# dynamic-dns
(Instant AP) (DHCP profile "<name>")# server-type <Distributed,L3>
(Instant AP) (DHCP profile "<name>")# dynamic-dns key <algo-name:keyname:keystring>
```

Verifying the Configuration

To view the DDNS status on an OAW-IAP:

```
(Instant AP)# show ddns
```

To view the list of DDNS clients:

```
(Instant AP)# show ddns clients
```

DHCP profile name is None for the Master OAW-IAP update sent.

The **show running-config** command displays the key in the encrypted format.

You can also configure dynamic DNS on an OAW-IAP or clients using the privileged execution mode in the CLI. For more information, refer to the **show ddns clients** command in the latest *Alcatel-Lucent AOS-W Instant CLI Reference Guide*.



This section provides the following information:

- [Understanding IAP-VPN Architecture on page 311](#)
- [Configuring OAW-IAP and switch for IAP-VPN Operations on page 314](#)
- [IAP-VPN Deployment Scenarios on page 322](#)

Understanding IAP-VPN Architecture

The IAP-VPN architecture includes the following two components:

- OAW-IAPs at branch sites
- switch at the datacenter

The master OAW-IAP at the branch site acts as the VPN endpoint and the switch at the datacenter acts as the VPN concentrator. When an OAW-IAP is set up for VPN, it forms an IPsec tunnel to the switch to secure sensitive corporate data. IPsec authentication and authorization between the switch and the OAW-IAPs are based on the RAP whitelist configured on the switch.



Only the master OAW-IAP in an OAW-IAP cluster forms the VPN tunnel.

From the switch perspective, the master OAW-IAPs that form the VPN tunnel are considered as VPN clients. The switch terminates VPN tunnels and routes or switches the VPN traffic. The OAW-IAP cluster creates an IPsec or GRE VPN tunnel from the virtual switch to a OmniAccess Mobility Controller in a branch office. The switch only acts as an IPsec or GRE VPN endpoint and it does not configure the OAW-IAP.

IAP-VPN Scalability Limits

The switch scalability in IAP-VPN architecture depends on factors such as IAP-VPN branches, route limit, and VLAN limit.

The following table provides the IAP-VPN scalability information for various switch platforms:

Table 75: IAP-VPN Scalability

Platforms	IAP-VPN Branches (Preferred)	Route Limit	VLAN Limit
7240	8192	32769	4094
7220	4096	32769	4094
7210	2048	32765	4094
7205	1024	16381	2048
7030	256	8189	256
7024	128	4093	128

Table 75: IAP-VPN Scalability

Platforms	IAP-VPN Branches (Preferred)	Route Limit	VLAN Limit
7010	128	4093	128
7008	64	4093	128
7005	64	4093	128

- **IAP-VPN Branches**—The number of IAP-VPN branches that can be terminated on a given switch platform.
- **Route Limit**—The number of L3 routes supported on the switch.
- **VLAN Limit**—The number of VLANs supported on the switch.

IAP-VPN Forwarding Modes

The forwarding modes determine whether the DHCP server and default gateway for clients reside in the branch or at the datacenter. These modes do not determine the firewall processing or traffic forwarding functionality. The virtual switch enables different DHCP pools (various assignment modes) in addition to allocating IP subnets for each branch.

The virtual switch allows different modes of forwarding traffic from the clients on a VLAN based on the DHCP scope configured on the OAW-IAP.

For the IAP-VPN deployments, the following forwarding modes are supported:

- Local mode
- L2 Switching mode
- L3 routing mode

The DHCP scopes associated with these forwarding modes are described in the following sections.



Ensure that VLAN 1 is not configured for any of the DHCP scopes as it is reserved for a different purpose.

Local Mode

In this mode, the OAW-IAP cluster at that branch has a local subnet and the master OAW-IAP of the cluster acts as the DHCP server and gateway for clients. The local mode provides access to the corporate network using the inner IP of the IPsec tunnel. The network address for traffic destined to the corporate network is translated at the source with the inner IP of the IPsec tunnel and is forwarded through the IPsec tunnel. The traffic destined to the non-corporate network is translated using the IP address of the OAW-IAP and is forwarded through the uplink.



When the local mode is used for forwarding client traffic, hosts on the corporate network cannot establish connections to the clients on the OAW-IAP, because the source addresses of the clients are translated.

Local, L2 Mode

In this mode, the OAW-IAP cluster at that branch has a local subnet and the master OAW-IAP of the cluster acts as the DHCP server. The default gateway is located outside the OAW-IAP and the network address for the client traffic is not translated at source. In the Local, L2 mode, access to the corporate network is supported only in a single OAW-IAP cluster. The traffic to the non-corporate network is locally bridged.

Local, L3 Mode

In this mode, the network address for traffic destined to the corporate network is translated at the source with the inner IP of the IPsec tunnel and is forwarded through the IPsec tunnel. The traffic destined to the non-corporate network is routed.

Distributed, L2 Mode

In this mode, the OAW-IAP assigns an IP address from the configured subnet and forwards traffic to both corporate and non-corporate destinations. Clients receive the corporate IP with virtual switch as the DHCP server. The default gateway for the client still resides in the datacenter and hence this mode is an L2 extension of corporate VLAN to remote site. Either the switch or an upstream router can be the gateway for the clients. Client traffic destined to datacenter resources is forwarded by the master OAW-IAP (through the IPsec tunnel) to the client's default gateway in the datacenter.

When an OAW-IAP registers with the switch, the switch automatically adds the VPN tunnel associated to this OAW-IAP into the VLAN multicast table. This allows the clients connecting to the L2 mode VLAN to be part of the same L2 broadcast domain on the switch.

Distributed, L3 Mode

The Distributed, L3 mode contains all broadcast and multicast traffic to a branch. The Distributed, L3 mode reduces the cost and eliminates the complexity associated with the classic site-to-site VPN. However, this mode is very similar to a classic site-to-site IPsec VPN where two VPN endpoints connect individual networks together over a public network.

In Distributed, L3 mode, each branch location is assigned a dedicated subnet. The master OAW-IAP in the branch manages the dedicated subnet and acts as the DHCP server and gateway for clients. Client traffic destined to datacenter resources is routed to the switch through the IPsec tunnel, which then routes the traffic to the appropriate corporate destinations.

When an OAW-IAP registers with the switch, the switch adds a route to enable the routing of traffic from the corporate network to clients on this subnet in the branch.

Centralized, L2 Mode

The Centralized, L2 mode extends the corporate VLAN or broadcast domain to remote branches. The DHCP server and the gateway for the clients reside in the datacenter. Either the switch or an upstream router can be the gateway for the clients. For DHCP services in Centralized, L2 mode, Alcatel-Lucent recommends using an external DHCP server and not the DHCP server on the switch. Client traffic destined to datacenter resources is forwarded by the master OAW-IAP (through the IPsec tunnel) to the client's default gateway in the datacenter.

Centralized, L3 Mode

For Centralized, L3 clients, the virtual switch acts as a DHCP relay agent that forwards the DHCP traffic to the DHCP server located behind the switch in the corporate network and reachable through the IPsec tunnel. The Centralized, L3 VLAN IP is used as the source IP. The IP address is obtained from the DHCP server.

DHCP Scope and VPN Forwarding Modes Mapping

The following table provides a summary of the DHCP scope and VPN forwarding modes mapping:

Table 76: DHCP Scope and VPN Forwarding Modes Matrix

Options	Local	Local, L2	Local, L3	Centralized, L2	Centralized, L3	Distributed, L2	Distributed, L3
DHCP server	Virtual switch	Virtual switch	Virtual switch	DHCP Server in the Datacenter	DHCP Server in the Datacenter and virtual switch acts as a relay agent	Virtual switch	Virtual switch
Default Gateway for clients	Virtual switch	Default Gateway in the local network	Virtual switch	switch or a router in the Datacenter	Virtual switch	switch or a router in the Datacenter	Virtual switch
Corporate Traffic	Source-NAT is performed with inner IP of the IPsec tunnel	Not applicable	Source-NAT is performed with inner IP of the IPsec tunnel	L2 reachable	Routed	L2 reachable	Routed
Internet Traffic	Source-NAT is performed with local IP of the Virtual switch	Locally bridged	Routed	Source-NAT is performed with local IP of the Virtual switch	Source-NAT is performed with local IP of the Virtual switch	Source-NAT is performed with local IP of the Virtual switch	Source-NAT is performed with local IP of the Virtual switch
Branch access from datacenter	No	No	No	Yes	Yes	Yes	Yes

Configuring OAW-IAP and switch for IAP-VPN Operations

This section describes the configuration procedures for the OAW-IAP and the switch to realize generic use cases. For information on specific deployment scenarios, see [IAP-VPN Deployment Scenarios on page 322](#).



This section describes the configuration procedures to perform on the OAW-IAP for generic use cases. For information on specific deployment scenarios, see [IAP-VPN Deployment Scenarios on page 322](#).

Configuring an OAW-IAP Network for IAP-VPN Operations

An OAW-IAP network requires the following configurations for IAP-VPN operations.

- [Defining the VPN Host Settings](#)
- [Configuring Routing Profiles](#)
- [Configuring DHCP Profiles](#)

- [Configuring an SSID or Wired Port Profile](#)
- [Enabling Dynamic RADIUS Proxy](#)
- [Configuring Enterprise Domains](#)

Defining the VPN Host Settings

The VPN endpoint on which a master OAW-IAP terminates its VPN tunnel is considered as the host. A master OAW-IAP in an OAW-IAP network can be configured with a primary and backup host to provide VPN redundancy. You can define VPN host settings through **More > Tunneling > Controller** in the old WebUI and through **Configuration > Tunneling > Controller** in the new WebUI.

You can configure the following VPN profiles for the IAP-VPN operations. For more information, see [Configuring a Tunnel from an OAW-IAP to an OmniAccess Mobility Controller on page 299](#).

- [Aruba IPsec](#)
- [L2TPv3](#)
- [Manual GRE](#)
- [Aruba GRE](#)

Configuring Routing Profiles

The routing profile on the OAW-IAP determines whether the traffic destined to a subnet must be tunneled through IPsec or bridged locally. If the routing profile is empty, the client traffic will always be bridged locally. For example, if the routing profile is configured to tunnel 10.0.0.0 /8, the traffic destined to 10.0.0.0 /8 will be forwarded through the IPsec tunnel and the traffic to all other destinations is bridged locally.

You can also configure a routing profile with 0.0.0.0 as gateway to allow both the client and OAW-IAP traffic to be routed through a non-tunnel route. If the gateway is in the same subnet as uplink IP address, it is used as a static gateway entry. A static route can be added to all master and slave OAW-IAPs for these destinations. The VPN traffic from the local subnet of OAW-IAP or the Virtual switch IP address in the local subnet is not routed to tunnel, but will be switched to the relevant VLAN. For example, when a 0.0.0.0/0.0.0.0 routing profile is defined, to bypass certain IPs, you can add a route to the IP by defining 0.0.0.0 as the destination, thereby forcing the traffic to be routed through the default gateway of the OAW-IAP.

You can configure routing profiles through **More > Tunneling > Controller** in the old WebUI and through **Configuration > Routing** in the new WebUI. For step-by-step procedural information on configuring routing profile, see [Configuring Routing Profiles on page 305](#).



The OAW-IAP network has only one active tunnel even when fast failover is enabled. At any given time, traffic can be tunneled only to one VPN host.

Configuring DHCP Profiles

You can create DHCP profiles to determine the IAP-VPN mode of operation. An OAW-IAP network can have multiple DHCP profiles configured for different modes of IAP-VPN. You can configure up to eight DHCP profiles. For more information on the IAP-VPN modes of operation, see [IAP-VPN Forwarding Modes on page 312](#).

You can create any of the following types of DHCP profiles for the IAP-VPN operations:

- Local
- Local, L2
- Local, L3
- Distributed, L2
- Distributed, L3
- Centralized, L2

- Centralized, L3

For more information on configuring DHCP profiles, see [Configuring DHCP Scopes on page 276](#).



A Centralized, L2 or Distributed, L2 VLAN or subnet cannot be used to serve OAW-IAPs in a hierarchical mode of deployment. Ensure that the physical IP of the OAW-IAPs connecting to the master OAW-IAP in hierarchical mode of deployment is not on a VLAN or subnet that is in Centralized, L2 or Distributed, L2 mode of operation. For information on hierarchical mode of deployment, see [Understanding Hierarchical Deployment on page 145](#).

Configuring an SSID or Wired Port Profile

For a client to connect to the IAP-VPN network, an SSID or wired port profile on an OAW-IAP must be configured with appropriate IAP-VPN mode of operation. The VLAN configuration in an SSID or wired port profile determines whether an SSID or wired port is configured for the IAP-VPN operations.

To configure an SSID or wired port for a specific IAP-VPN mode, the VLAN ID defined in the SSID or wired port profile must match the VLAN ID defined in the DHCP profile configuration. If the VLAN assignment for an SSID or wired port profile is set to Virtual switch assigned, custom, or a static VLAN ID that does not match the VLAN ID configured in the DHCP profiles, the IAP-VPN operations are affected. For example, if a local DHCP profile is configured with a VLAN ID of 200, the VLAN configuration on the SSID must be set to a static VLAN ID 200.



Ensure that the VLAN assignment for an SSID or wired port profile is not set to default as the VPN tunnel is not supported on the default VLAN.

An OAW-IAP will not send a registration request to the switch if **SetMeUp** is configured on the OAW-IAP.

For information on how to configure an SSID or wired port profile, see [Wireless Network Profiles on page 100](#) and [Configuring a Wired Profile on page 134](#), respectively.

Enabling Dynamic RADIUS Proxy

The RADIUS server can be deployed at different locations and VLANs. In most cases, a centralized RADIUS or local server is used to authenticate users. However, some user networks can use a local RADIUS server for employee authentication and a centralized RADIUS-based captive portal server for guest authentication. To ensure that the RADIUS traffic is routed to the required RADIUS server, the dynamic RADIUS proxy feature must be enabled. When enabled, dynamic RADIUS proxy ensures that all the RADIUS traffic is sourced from the Virtual switch IP or inner IP of the OAW-IAP IPsec tunnel depending on the RADIUS server IP and routing profile.



Ensure that a static Virtual switch IP is configured before enabling dynamic RADIUS proxy in order to tunnel the RADIUS traffic to the central RADIUS server in the datacenter.

For information on enabling dynamic RADIUS proxy, see [Configuring Dynamic RADIUS Proxy Parameters on page 209](#).

Configuring Enterprise Domains

By default, all the DNS requests from a client are forwarded to the client's DNS server. In a typical OAW-IAP deployment without VPN configuration, client DNS requests are resolved by the DNS server of clients. For the IAP-VPN scenario, the enterprise domain settings on the OAW-IAP are used to determine how client DNS requests are routed. For information on how to configure enterprise domains, see [Configuring Enterprise Domains on page 256](#).

Configuring a switch for IAP-VPN Operations

Alcatel-Lucent switches provide an ability to terminate the IPsec and GRE VPN tunnels from the OAW-IAP and provide corporate connectivity to the branch network.

For IAP-VPN operations, ensure that the following configuration and verification procedures are completed on the switch:

- [OSPF Configuration](#)
- [VPN Configuration](#)
- [Branch-ID Allocation](#)
- [Branch Status Verification](#)



This section describes the configuration procedures for the switch to realize generic use cases. For information on specific deployment scenarios, see [IAP-VPN Deployment Scenarios on page 322](#).



AOS-W 6.3.0.0 or later version is recommended for the switches with IAP-VPN configuration.

OSPF Configuration

OSPF is a dynamic IGP based on IETF RFC 2328. The premise of OSPF is that the shortest or fastest routing path is used. The implementation of OSPFv2 allows switches to deploy effectively in a Layer 3 topology. The switches can act as the default gateway for all clients and forward user packets to the upstream router.

Each IAP-VPN can be defined a separate subnet derived from the corporate intranet pool to allow IAP-VPN devices to work independently. For sample topology, refer to the *AOS-W User Guide*.

To configure general OSPF settings from the switch, perform the following steps:

1. Navigate to the **Configuration > IP** page. The Area and Excluded subnets are displayed in table format. If not explicitly specified for OSPF, the router ID defaults to the switch IP.

Figure 8 General OSPF Configuration

Network	Stub	No-summary	Default Cost	NSSA	Default Information to NSSA Area	No Redistribution to NSSA Area	No LSA Summary	Action
<input type="button" value="Add"/>								

Network	Subnet	Action
<input type="button" value="Add"/>		

2. Click **Add** to add an area.

Figure 9 Add an OSPF Area

Network > IP > OSPF > Add Area

Area Network (eg. 192.168.1.1)

Default Cost

Stub

No-summary

NSSA

Default Information

No Redistribution

No LSA summary

Done Cancel

3. Configure the OSPF interface settings in the Configuration screen. If OSPF is enabled, the parameters contain the correct default values. You can edit the OSPF values only when you enable OSPF on the interface.

Figure 10 Edit OSPF VLAN Settings

Network > IP > IP Interface > Edit VLAN (1)

Details

VLAN ID

Obtain an IP address from DHCP

Client ID

Obtain an IP address with PPPoE

Service name

Username

Password

Confirm Password

Use the following IP address

IP Address

Net Mask

Uplink Priority

DHCP Helper Addresses

No Helper Addresses

Add

IGMP

Enable IGMP

Snooping

Proxy Interface

NAT

Enable source NAT for this VLAN

Inter-VLAN Routing

Enable Inter-VLAN Routing

MLD

Enable MLD

Snooping

BCMC (Broadcast-Multicast) Optimization

Enable BCMC Optimization

OSPF

Enable OSPF

Area Network (eg. 192.168.1.1)

Authentication Message-digest

Message-digest Key

Key [1-255]

Password

Cost [1-65535]

Dead Interval [1-65535]

Hello Interval [1-65535]

Priority [0-255]

Retransmit Interval [1-65535]

Transmit Delay [1-65535]

Apply

OSPF monitoring is available from an IP Routing sub-section (**Controller > IP Routing > Routing**). Both Static and OSPF routes are available in table format.

OSPF Interfaces and Neighboring information is available from the **OSPF** tab. The Interface information includes transmit (TX) and receive (RX) statistics.

To redistribute IAP-VPN routes into the OSPF process:

```
(host)(config) # router ospf redistribute rapng-vpn
```

To verify if the redistribution of the IAP-VPN is enabled:

```
(host) #show ip ospf redistribute
```

To configure aggregate route for IAP-VPN routes:

```
(host) (config) # router ospf aggregate-route rapng-vpn
```

To view the aggregated routes for IAP-VPN routes:

```
(host) #show ip ospf rapng-vpn aggregate-routes  
RAPNG VPN aggregate routes
```

```
-----  
Prefix Mask Contributing routes Cost  
-----  
201.201.200.0 255.255.252.0 5 268779624  
100.100.2.0 255.255.255.0 1 10
```

To verify the details of a configured aggregated route:

```
(host) # show ip ospf rapng-vpn aggregated-routes <net> <mask>  
(host) # show ip ospf rapng-vpn aggregate-routes 100.100.2.0 255.255.255.0  
Contributing routes of RAPNG VPN aggregate route
```

```
-----  
Prefix Mask Next-Hop Cost  
-----  
100.100.2.64 255.255.255.224 5.5.0.10 10
```

To view all the redistributed routes:

```
(host)# show ip ospf database  
OSPF Database Table
```

```
-----  
Area ID      LSA Type      Link ID      Adv Router    Age   Seq#          Checksum  
-----  
0.0.0.15    ROUTER        9.9.9.9      9.9.9.9      159  0x80000016   0xee92  
0.0.0.15    ROUTER        10.15.148.12 10.15.148.12 166  0x80000016   0x4c0d  
0.0.0.15    NETWORK      10.15.148.12 10.15.148.12 167  0x80000001   0x9674  
0.0.0.15    NSSA         12.12.2.0    9.9.9.9      29   0x80000003   0x7b54  
0.0.0.15    NSSA         12.12.12.0   9.9.9.9      164  0x80000008   0x63a  
0.0.0.15    NSSA         12.12.12.32  9.9.9.9      164  0x80000008   0x7b8  
0.0.0.15    NSSA         50.40.40.0   9.9.9.9      164  0x80000007   0x8ed4  
0.0.0.15    NSSA         51.41.41.128 9.9.9.9      164  0x80000007   0x68f6  
0.0.0.15    NSSA         53.43.43.32  9.9.9.9      164  0x80000007   0x2633  
0.0.0.15    NSSA         54.44.44.16  9.9.9.9      164  0x80000007   0x353  
N/A        AS_EXTERNAL  12.12.2.0    9.9.9.9      29   0x80000003   0x8c06  
N/A        AS_EXTERNAL  12.12.12.0   9.9.9.9      169  0x80000001   0x25e4  
N/A        AS_EXTERNAL  12.12.12.32  9.9.9.9      169  0x80000001   0x2663  
N/A        AS_EXTERNAL  50.40.40.0   9.9.9.9      169  0x80000001   0xab80  
N/A        AS_EXTERNAL  51.41.41.128 9.9.9.9      169  0x80000001   0x85a2  
N/A        AS_EXTERNAL  53.43.43.32  9.9.9.9      169  0x80000001   0x43de  
N/A        AS_EXTERNAL  54.44.44.16  9.9.9.9      169  0x80000001   0x20fe
```

To verify if the redistributed routes are installed or not:

```
(host)# show ip route  
Codes: C - connected, O - OSPF, R - RIP, S - static  
M - mgmt, U - route usable, * - candidate default, V - RAPNG VPN  
Gateway of last resort is Imported from DHCP to network 0.0.0.0 at cost 10  
Gateway of last resort is Imported from CELL to network 0.0.0.0 at cost 10  
Gateway of last resort is Imported from PPPOE to network 0.0.0.0 at cost 10  
Gateway of last resort is 10.15.148.254 to network 0.0.0.0 at cost 1  
S*    0.0.0.0/0 [1/0] via 10.15.148.254*  
V    12.12.2.0/24 [10/0] ipsec map  
V    12.12.12.0/25 [10/0] ipsec map  
V    12.12.12.32/27 [10/0] ipsec map  
V    50.40.40.0/24 [10/0] ipsec map  
V    51.41.41.128/25 [10/0] ipsec map  
V    53.43.43.32/27 [10/0] ipsec map  
V    54.44.44.16/28 [10/0] ipsec map
```

```
C 9.9.9.0/24 is directly connected, VLAN9
C 10.15.148.0/24 is directly connected, VLAN1
C 43.43.43.0/24 is directly connected, VLAN132
C 42.42.42.0/24 is directly connected, VLAN123
C 44.44.44.0/24 is directly connected, VLAN125
C 182.82.82.12/32 is an ipsec map 10.15.149.69-182.82.82.12
C 182.82.82.14/32 is an ipsec map 10.17.87.126-182.82.82.14
```

VPN Configuration

The following VPN configuration steps on the switch enable the OAW-IAPs to terminate their VPN connection on the switch:

Whitelist Database Configuration

The whitelist database is a list of the MAC addresses of the OAW-IAPs that are allowed to establish VPN connections with the switch. This list can be either stored in the switch database or on an external server.

You can use the following CLI command to configure the whitelist database entries if the switch is acting as the whitelist database:

```
(host)# whitelist-db rap add mac-address 00:11:22:33:44:55 ap-group test
```

The **ap-group** parameter is not used for any configuration, but needs to be configured. The parameter can be any valid string.

If an external server is used as the location for the whitelist database, add the MAC addresses of the valid OAW-IAPs in the external database or external directory server and then configure a RADIUS server to authenticate the OAW-IAPs using the entries in the external database or external directory server.

If you are using the Windows 2003 server, perform the following steps to configure the external whitelist database on it. There are equivalent steps available for the Windows Server 2008 and other RADIUS servers.

1. Add the MAC addresses of all the OAW-IAPs in the Active Directory of the RADIUS server:
 - a. Open the **Active Directory and Computers** window, add a new user and specify the MAC address (without the colon delimiter) of the OAW-IAP for the username and password, respectively.
 - b. Right-click the user that you have just created and click **Properties**.
 - c. On the **Dial-in** tab, select **Allow access** in the **Remote Access Permission** section and click **OK**.
 - d. Repeat Step a through Step c for all OAW-IAPs.
2. Define the remote access policy in the IAS:
 - a. In the **Internet Authentication Service** window, select **Remote Access Policies**.
 - b. Launch the wizard to configure a new remote access policy.
 - c. Define filters and select **grant remote access permission** in the **Permissions** window.
 - d. Right-click the policy that you have just created and select **Properties**.
 - e. In the **Settings** tab, select the policy condition, and click **Edit Profile**.
 - f. In the **Advanced** tab, select **Vendor Specific**, and click **Add** to add a new VSAs.
 - g. Add a new VSA and click **OK**.
 - h. In the **IP** tab, provide the IP address of the OAW-IAP and click **OK**.

VPN Local Pool Configuration

The VPN local pool is used to assign an IP address to the OAW-IAP after successful XAUTH VPN.

```
(host) # ip local pool "rapngpool" <startip> <endip>
```

Role Assignment for the Authenticated OAW-IAPs

Define a role that includes an Source-NAT rule to allow connections to the RADIUS server and for the Dynamic RADIUS Proxy in the OAW-IAP to work. This role is assigned to OAW-IAPs after successful authentication.

```
(host) (config) #ip access-list session iaprole
(host) (config-sess-iaprole)#any host <radius-server-ip> any src-nat
(host) (config-sess-iaprole)#any any any permit
(host) (config-sess-iaprole)#!
(host) (config) #user-role iaprole
(host) (config-role) #session-acl iaprole
```

VPN Profile Configuration

The VPN profile configuration defines the server used to authenticate the OAW-IAP (internal or an external server) and the role assigned to the OAW-IAP after successful authentication.

```
(host) (config) #aaa authentication vpn default-iap
(host) (VPN Authentication Profile "default-iap") #server-group default
(host) (VPN Authentication Profile "default-iap") #default-role iaprole
```

Branch-ID Allocation

For branches deployed in Distributed, L3 and Distributed, L2 modes, the master OAW-IAP in the branch and the switch should agree upon a subnet or IP addresses to be used for DHCP services in the branch. The process or protocol used by the master OAW-IAP and the switch to determine the subnet or IP addresses used in a branch is called BID allocation. The BID allocation process is not essential for branches deployed in local or Centralized, L2 mode. The following are some of the key functions of the BID allocation process:

- Determines the IP addresses used in a branch for Distributed, L2 mode
- Determines the subnet used in a branch for Distributed, L3 mode
- Avoids IP address or subnet overlap (that is, avoids IP conflict)
- Ensures that a branch is allocated the same subnet or range of IP addresses irrespective of which OAW-IAP in the branch becomes the master in the OAW-IAP cluster

Branch Status Verification

To view the details of the branch information connected to the switch, execute the **show iap table** command.

Example

This example shows the details of the branches connected to the switch:

```
(host) #show iap table long
```

IAP Branch Table

Name	VC MAC Address	Status	Inner IP	Assigned Subnet	Assigned Vlan
Tokyo-CB:D3:16	6c:f3:7f:cc:42:f8	DOWN	0.0.0.0		
Paris-CB:D3:16	6c:f3:7f:cc:3d:04	UP	10.15.207.140	10.15.206.99/29	2
LA	6c:f3:7f:cc:42:25	UP	10.15.207.111	10.15.206.24/29	2
Munich	d8:c7:c8:cb:d3:16	DOWN	0.0.0.0		
London-c0:e1	6c:f3:7f:c0:e1:b1	UP	10.15.207.120	10.15.206.64/29	2
Instant-CB:D3	6c:f3:7f:cc:42:1e	DOWN	0.0.0.0		
Delhi	6c:f3:7f:cc:42:ca	DOWN	0.0.0.0		
Singapore	6c:f3:7f:cc:42:cb	UP	10.15.207.122	10.15.206.120/29	2

Key Bid(Subnet Name)

```
---
b3c65c...
b3c65c...
b3c65c... 2(10.15.205.0-10.15.205.250,5),1(10.15.206.1-10.15.206.252,5)
```

```

a2a65c... 0
b3c65c... 7(10.15.205.0-10.15.205.250,5),8(10.15.206.1-10.15.206.252,5)
b3c65c...
b3c65c... 1(10.15.205.0-10.15.205.250,5),2(10.15.206.1-10.15.206.252,5)
b3c65c... 14(10.15.205.0-10.15.205.250,5),15(10.15.206.1-10.15.206.252,5)

```

The output of this command provides the following information:

Table 77: Branch Details

Parameter	Description
Name	Displays the name of the branch.
VC MAC Address	Displays the MAC address of the virtual switch of the branch.
Status	Displays the current status of the branch (UP or DOWN).
Inner IP	Displays the internal VPN IP of the branch.
Assigned Subnet	Displays the subnet mask assigned to the branch.
Assigned Vlan	Displays the VLAN ID assigned to the branch.
Key	Displays the key for the branch, which is unique to each branch.
Bid(Subnet Name)	<p>Displays the branch ID of the subnet.</p> <p>In the example above, the switch displays bid-per-subnet-per-branch i.e., for "LA" branch, BID "2" for the ip-range "10.15.205.0-10.15.205.250" with client count per branch "5". If a branch has multiple subnets, it can have multiple BIDs.</p> <p>If a branch is in UP state and does not have a Bid(Subnet Name), it means that the OAW-IAP is connected to a switch, which did not assign any BID for any subnet. In the above example, "Paris-CB:D3:16" branch is UP and does not have a Bid(Subnet Name). This means that either the OAW-IAP is connected to a backup switch or it is connected to a primary switch without any Distributed, L2 or Distributed, L3 subnets.</p>



The **show iap table** command output does not display the **Key** and **Bid(Subnet Name)** details.

IAP-VPN Deployment Scenarios

This section describes the most common IAP-VPN deployment models and provides information to carry out the necessary configuration procedures. The examples in this section refer to more than one DHCP profile and wired port configuration in addition to wireless SSID configuration. All these are optional. In most networks, a single DHCP profile and wireless SSID configuration referring to a DHCP profile is sufficient.

The following scenarios are described in this section:

- [Scenario 1—IPsec: Single Datacenter Deployment with No Redundancy on page 323](#)
- [Scenario 2—IPsec: Single Datacenter with Multiple switch for Redundancy on page 327](#)
- [Scenario 3—IPsec: Multiple Datacenter Deployment with Primary and Backup switch for Redundancy on page 332](#)
- [Scenario 4—GRE: Single Datacenter Deployment with No Redundancy on page 338](#)

Scenario 1—IPsec: Single Datacenter Deployment with No Redundancy

This scenario includes the following configuration elements:

1. Single VPN primary configuration using IPsec.
2. Split-tunneling of client traffic.
3. Split-tunneling of DNS traffic from clients.
4. Distributed, L3 and Centralized, L2 mode DHCP.
5. RADIUS server within corporate network and authentication survivability for branch survivability.
6. Wired and wireless users in L2 and L3 modes, respectively.
7. Access rules defined for wired and wireless networks to permit all traffic.

Topology

[Figure 11](#) shows the topology and the IP addressing scheme used in this scenario.

Figure 11 Scenario 1—IPsec: Single datacenter Deployment with No Redundancy

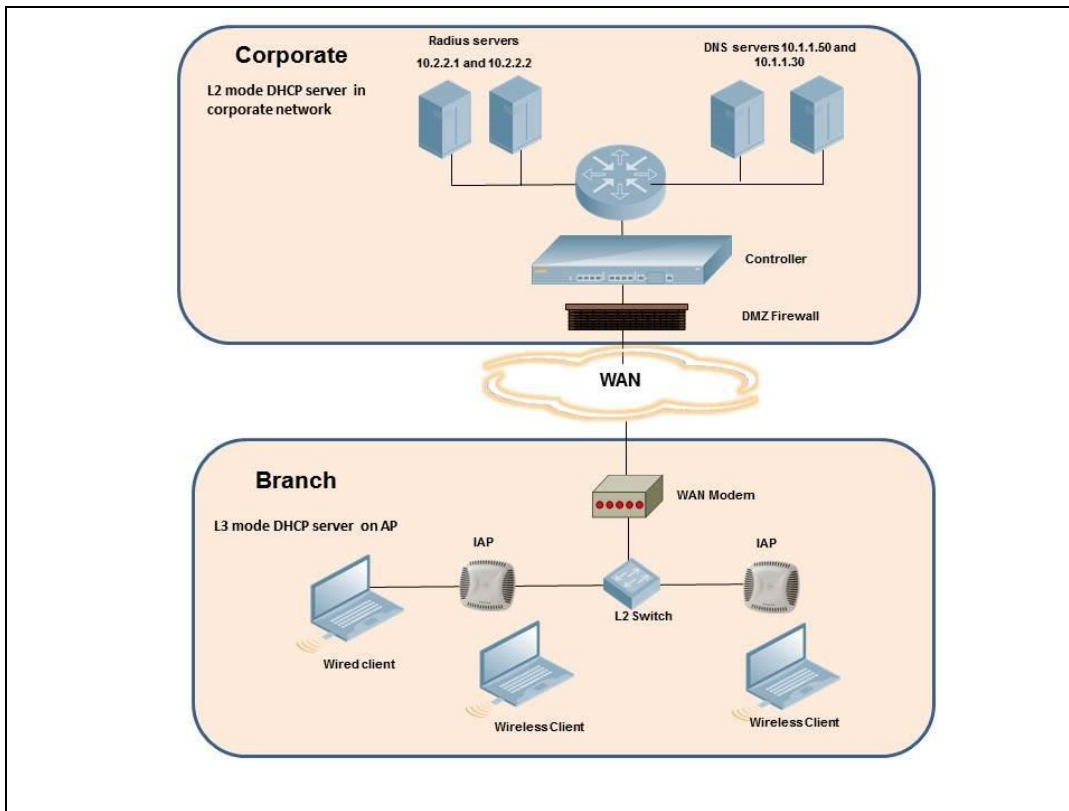

The following IP addresses are used in the examples for this scenario:

- 10.0.0.0/8 is the corporate network
- 10.20.0.0/16 subnet is reserved for L2 mode
- 10.30.0.0/16 subnet is reserved for L3 mode
- Client count in each branch is 200

OAW-IAP Configuration

The following table provides information on the configuration steps performed through the CLI with example values. For information on the WebUI procedures, see the topics referenced in the *WebUI Procedure* column.

Table 78: OAW-IAP Configuration for Scenario 1—IPsec: Single Datacenter Deployment with No Redundancy

Configuration Steps	CLI Commands	WebUI Procedure
Configure the primary host for VPN with the Public VRRP IP address of the switch.	<ul style="list-style-type: none"> ■ (Instant AP) (config)# vpn primary <public VRRP IP of switch> 	See Configuring an IPsec Tunnel
Configure a routing profile to tunnel all 10.0.0.0/8 subnet traffic to switch.	<ul style="list-style-type: none"> ■ (Instant AP) (config)# routing-profile ■ (Instant AP) (routing-profile)# route 10.0.0.0 255.0.0.0 <public VRRP IP of switch> 	See Configuring Routing Profiles
Configure Enterprise DNS for split DNS. The example in the next column uses a specific enterprise domain to only tunnel all DNS queries matching that domain to corporate.	<ul style="list-style-type: none"> ■ (Instant AP) (config)# internal-domains ■ (Instant AP) (domains)# domain-name corpdomain.com 	See Configuring Enterprise Domains
Configure Centralized, L2 and Distributed, L3 with VLAN 20 and VLAN 30, respectively.	<p>Centralized, L2 profile</p> <ul style="list-style-type: none"> ■ (Instant AP) (config)# ip dhcp 12-dhcp ■ (Instant AP) (DHCP Profile "12-dhcp")# server-type Centralized,L2 ■ (Instant AP) (DHCP Profile "12-dhcp")# server-vlan 20 <p>Distributed, L3 profile</p> <ul style="list-style-type: none"> ■ (Instant AP) (config)# ip dhcp 13-dhcp ■ (Instant AP) (DHCP Profile "13-dhcp")# server-type Distributed,L3 ■ (Instant AP) (DHCP Profile "13-dhcp")# server-vlan 30 ■ (Instant AP) (DHCP Profile "13-dhcp")# ip-range 10.30.0.0 10.30.255.255 ■ (Instant AP) (DHCP Profile "13-dhcp")# dns-server 10.1.1.50,10.1.1.30 ■ (Instant AP) (DHCP Profile "13-dhcp")# domain-name corpdomain.com ■ (Instant AP) (DHCP Profile "13-dhcp")# client-count 200 <p>NOTE: The IP range configuration on each branch will be the same. Each OAW-IAP will derive a smaller subnet</p>	See Enabling DHCP Relay Agent Information Option (Option 82) and Configuring Distributed DHCP Scopes

Table 78: OAW-IAP Configuration for Scenario 1—IPsec: Single Datacenter Deployment with No Redundancy

Configuration Steps	CLI Commands	WebUI Procedure
	based on the client count scope using the BID allocated by switch.	
Create authentication servers for user authentication. The example in the next column assumes 802.1X SSID.	<ul style="list-style-type: none"> ■ (Instant AP) (config)# wlan auth-server server1 ■ (Instant AP) (Auth Server "server1")# ip 10.2.2.1 ■ (Instant AP) (Auth Server "server1")# port 1812 ■ (Instant AP) (Auth Server "server1")# acctport 1813 ■ (Instant AP) (Auth Server "server1")# key "presharedkey" ■ (Instant AP) (Auth Server "server1")# exit ■ (Instant AP) (config)# wlan auth-server server2 ■ (Instant AP) (Auth Server "server2")# ip 10.2.2.2 ■ (Instant AP) (Auth Server "server2")# port 1812 ■ (Instant AP) (Auth Server "server2")# acctport 1813 ■ (Instant AP) (Auth Server "server2")# key "presharedkey" 	See Configuring an External Server for Authentication
Configure wired port and wireless SSIDs using the authentication servers.	<p>Configure wired ports to operate in L2 mode and associate Centralized, L2 mode VLAN 20 to the wired port profile.</p> <ul style="list-style-type: none"> ■ (Instant AP) (config) # wired-port-profile wired-port ■ (Instant AP) (wired-port-profile "wired-port")# switchport-mode access ■ (Instant AP) (wired-port-profile "wired-port")# allowed-vlan all ■ (Instant AP) (wired-port-profile "wired-port")# native-vlan 20 ■ (Instant AP) (wired-port-profile "wired-port")# no shutdown ■ (Instant AP) (wired-port-profile "wired-port")# access-rule-name wired-port ■ (Instant AP) (wired-port-profile "wired-port")# type employee 	See Configuring a Wired Profile and Wireless Network Profiles

Table 78: OAW-IAP Configuration for Scenario 1—IPsec: Single Datacenter Deployment with No Redundancy

Configuration Steps	CLI Commands	WebUI Procedure
	<ul style="list-style-type: none"> ■ (Instant AP) (wired-port-profile "wired-port")# auth-server server1 ■ (Instant AP) (wired-port-profile "wired-port")# auth-server server2 ■ (Instant AP) (wired-port-profile "wired-port")# dot1x ■ (Instant AP) (wired-port-profile "wired-port")# exit ■ (Instant AP) (config)# enet1-port-profile wired-port <p>Configure a wireless SSID to operate in L3 mode and associate Distributed, L3 mode VLAN 30 to the WLAN SSID profile.</p> <ul style="list-style-type: none"> ■ (Instant AP) (config) # wlan ssid-profile wireless-ssid ■ (Instant AP) (SSID Profile "wireless-ssid")# enable ■ (Instant AP) (SSID Profile "wireless-ssid")# type employee ■ (Instant AP) (SSID Profile "wireless-ssid")# essid wireless-ssid ■ (Instant AP) (SSID Profile "wireless-ssid")# opmode wpa2-aes ■ (Instant AP) (SSID Profile "wireless-ssid")# vlan 30 ■ (Instant AP) (SSID Profile "wireless-ssid")# auth-server server1 ■ (Instant AP) (SSID Profile "wireless-ssid")# auth-server server2 ■ (Instant AP) (SSID Profile "wireless-ssid")# auth-survivability 	
<p>Create access rule for wired and wireless authentication. In this example, the rule permits all traffic.</p>	<p>For wired profile:</p> <ul style="list-style-type: none"> ■ (Instant AP) (config)# wlan access-rule wired-port ■ (Instant AP) (Access Rule "wired-port")# rule any any match any any permit <p>For WLAN SSID:</p> <ul style="list-style-type: none"> ■ (Instant AP) (config)# wlan access-rule wireless-ssid 	<p>See Configuring ACL Rules for Network Services</p>

Table 78: OAW-IAP Configuration for Scenario 1—IPsec: Single Datacenter Deployment with No Redundancy

Configuration Steps	CLI Commands	WebUI Procedure
	<ul style="list-style-type: none">■ (Instant AP) (Access Rule "wireless-ssid")# rule any any match any any any permit	
NOTE: Ensure that you execute the commit apply command in the AOS-W Instant CLI before saving the configuration and propagating changes across the OAW-IAP cluster.		

OAW-IAP-Connected Switch Configuration

Client VLANs defined in this example must be opened on the upstream switches in multiple OAW-IAP deployments, as client traffic from the slave to the master is tagged with the client VLAN.

Datacenter Configuration

For information on switch configuration, see [Configuring a switch for IAP-VPN Operations on page 317](#). Ensure that the upstream router is configured with a static route pointing to the switch for the L3 VLAN.

Scenario 2—IPsec: Single Datacenter with Multiple switch for Redundancy

This scenario includes the following configuration elements:

- A VRRP instance between the master or standby-master pair, which is configured as the primary VPN IP address.
- Tunneling of all traffic to datacenter.
- Exception route to bypass tunneling of RADIUS and OmniVista 3600 Air Manager traffic, which are locally reachable in the branch and the Internet, respectively.
- All client DNS queries are tunneled to the switch.
- Distributed, L3 and Centralized, L2 mode DHCP on all branches. L3 is used by the employee network and L2 is used by the guest network with captive portal.
- Wired and wireless users in L2 and L3 modes.
- Access rules defined for wired and wireless networks.

Topology

Figure 12 shows the topology and the IP addressing scheme used in this scenario.

Figure 12 Scenario 2—IPsec: Single Datacenter with Multiple switches for Redundancy

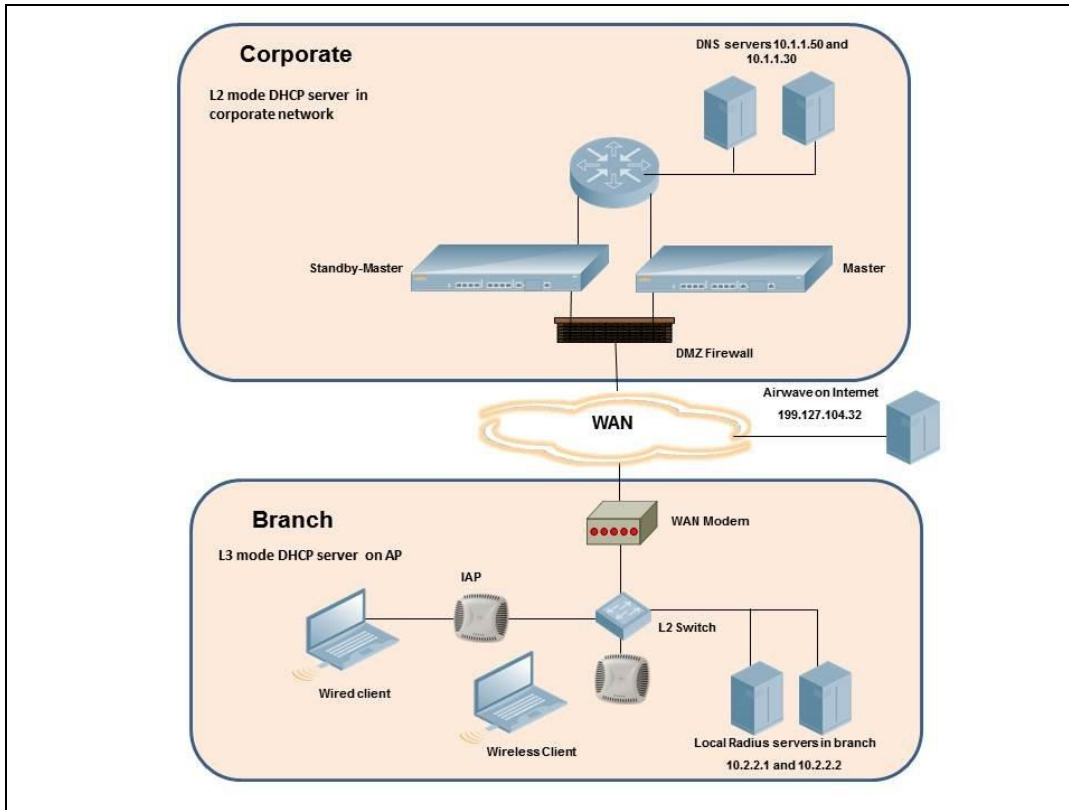

The following IP addresses are used in the examples for this scenario:

- 10.0.0.0/8 is the corporate network
- 10.20.0.0/16 subnet is reserved for L2 mode – used for guest network
- 10.30.0.0/16 subnet is reserved for L3 mode
- Client count in each branch is 200
- 10.2.2.0/24 is a branch-owned subnet, which needs to override global routing profile
- 199.127.104.32 is used as an example IP address of the OmniVista 3600 Air Manager server in the Internet

OAW-IAP Configuration

The following table provides information on the configuration steps performed through the CLI with example values. For information on the UI procedures, see the topics referenced in the *UI Procedure* column.

Table 79: OAW-IAP Configuration for Scenario 2—IPsec: Single Datacenter with Multiple switches for Redundancy

Configuration Steps	CLI Commands	WebUI Procedure
1. Configure the primary host for VPN with the Public VRRP IP address of the switch.	<ul style="list-style-type: none"> ■ (Instant AP) (config)# vpn primary <public VRRP IP of switch> 	See Configuring an IPsec Tunnel
2. Configure routing profiles to tunnel traffic through IPsec.	<ul style="list-style-type: none"> ■ (Instant AP) (config)# routing-profile ■ (Instant AP) (routing-profile)# route 0.0.0.0 0.0.0.0 <public VRRP IP of switch> 	See Configuring Routing Profiles
3. Define routing profile exception RADIUS server and OmniVista 3600 Air Manager IPs, since the design requirement for this solution requires local RADIUS authentication, even though the IP matches the routing profile destination.	<ul style="list-style-type: none"> ■ (Instant AP) (config)# routing-profile ■ (Instant AP) (routing-profile)# route 10.2.2.1 255.255.255.255 0.0.0.0 ■ (Instant AP) (routing-profile)# route 10.2.2.2 255.255.255.255 0.0.0.0 ■ (Instant AP) (routing-profile)# route 199.127.104.32 255.255.255.255 0.0.0.0 	See Configuring Routing Profiles
4. Configure Enterprise DNS. The configuration example in the next column tunnels all DNS queries to the original DNS server of clients without proxying on OAW-IAP.	<ul style="list-style-type: none"> ■ (Instant AP) (config)# internal-domains ■ (Instant AP) (domains)# domain-name * 	See Configuring Enterprise Domains
5. Configure Centralized, L2 and Distributed, L3 with VLAN 20 and VLAN 30, respectively.	<p>Centralized, L2 profile</p> <ul style="list-style-type: none"> ■ (Instant AP) (config)# ip dhcp l2-dhcp ■ (Instant AP) (DHCP Profile "l2-dhcp")# server-type Centralized,L2 ■ (Instant AP) (DHCP Profile "l2-dhcp")# server-vlan 20 <p>Distributed, L3 profile</p> <ul style="list-style-type: none"> ■ (Instant AP) (config)# ip dhcp l3-dhcp ■ (Instant AP) (DHCP Profile "l3-dhcp")# server-type Distributed,L3 ■ (Instant AP) (DHCP Profile "l3-dhcp")# server-vlan 30 ■ (Instant AP) (DHCP Profile "l3-dhcp")# ip-range 10.30.0.0 10.30.255.255 	See Enabling DHCP Relay Agent Information Option (Option 82) and Configuring Distributed DHCP Scopes

Table 79: OAW-IAP Configuration for Scenario 2—IPsec: Single Datacenter with Multiple switches for Redundancy

Configuration Steps	CLI Commands	WebUI Procedure
	<ul style="list-style-type: none"> ■ (Instant AP) (DHCP Profile "l3-dhcp")# dns-server 10.1.1.50,10.1.1.30 ■ (Instant AP) (DHCP Profile "l3-dhcp")# domain-name corpdomain.com ■ (Instant AP) (DHCP Profile "l3-dhcp")# client-count 200 <p>NOTE: The IP range configuration on each branch will be the same. Each OAW-IAP will derive a smaller subnet based on the client count scope using the BID allocated by switch.</p>	
<p>6. Create authentication servers for user authentication. The example in the next column assumes 802.1X SSID.</p>	<ul style="list-style-type: none"> ■ (Instant AP) (config)# wlan auth-server server1 ■ (Instant AP) (Auth Server "server1")# ip 10.2.2.1 ■ (Instant AP) (Auth Server "server1")# port 1812 ■ (Instant AP) (Auth Server "server1")# acctport 1813 ■ (Instant AP) (Auth Server "server1")# key "presharedkey" ■ (Instant AP) (Auth Server "server1")# exit ■ (Instant AP) (config)# wlan auth-server server2 ■ (Instant AP) (Auth Server "server2")# ip 10.2.2.2 ■ (Instant AP) (Auth Server "server2")# port 1812 ■ (Instant AP) (Auth Server "server2")# acctport 1813 ■ (Instant AP) (Auth Server "server2")# key "presharedkey" 	<p>See Configuring an External Server for Authentication</p>
<p>7. Configure wired port and wireless SSIDs using the authentication servers.</p>	<p>Configure wired ports to operate in L3 mode and associate Distributed, L3 mode VLAN 30 to the wired port profile.</p> <ul style="list-style-type: none"> ■ (Instant AP) (config) # wired-port-profile wired-port ■ (Instant AP) (wired-port-profile "wired-port")# switchport-mode access ■ (Instant AP) (wired-port-profile "wired-port")# allowed-vlan all ■ (Instant AP) (wired-port-profile "wired-port")# native-vlan 30 ■ (Instant AP) (wired-port-profile "wired-port")# no shutdown 	<p>See Configuring a Wired Profile and Wireless Network Profiles</p>

Table 79: OAW-IAP Configuration for Scenario 2—IPsec: Single Datacenter with Multiple switches for Redundancy

Configuration Steps	CLI Commands	WebUI Procedure
	<ul style="list-style-type: none"> ■ (Instant AP) (wired-port-profile "wired-port")# access-rule-name wired-port ■ (Instant AP) (wired-port-profile "wired-port")# type employee ■ (Instant AP) (wired-port-profile "wired-port")# auth-server server1 ■ (Instant AP) (wired-port-profile "wired-port")# auth-server server2 ■ (Instant AP) (wired-port-profile "wired-port")# dot1x ■ (Instant AP) (wired-port-profile "wired-port")# exit ■ (Instant AP) (config)# enet1-port-profile wired-port <p>Configure a wireless SSID to operate in L2 mode and associate Centralized, L2 mode VLAN 20 to the WLAN SSID profile.</p> <ul style="list-style-type: none"> ■ (Instant AP) (config) # wlan ssid-profile guest ■ (Instant AP) (SSID Profile "guest")# enable ■ (Instant AP) (SSID Profile "guest")# type guest ■ (Instant AP) (SSID Profile "guest")# essid guest ■ (Instant AP) (SSID Profile "guest")# opmode opensystem ■ (Instant AP) (SSID Profile "guest")# vlan 20 ■ (Instant AP) (SSID Profile "guest")# auth-server server1 ■ (Instant AP) (SSID Profile "guest")# auth-server server2 ■ (Instant AP) (SSID Profile "guest")# captive-portal internal <p>NOTE: This example uses internal captive portal use case using external authentication server. You can also use an external captive portal example.</p> <p>NOTE: The SSID type guest is used in this example to enable configuration of captive portal. However, corporate access through VPN tunnel is still allowed for this SSID because the VLAN associated to this SSID is a VPN-enabled VLAN (20 in this example).</p>	
<p>8. Create access rule for wired and wireless authentication. In this example, the rule permits all</p>	<p>For wired profile:</p> <ul style="list-style-type: none"> ■ (Instant AP) (config)# wlan 	<p>See Configuring ACL Rules for Network Services</p>

Table 79: OAW-IAP Configuration for Scenario 2—IPsec: Single Datacenter with Multiple switches for Redundancy

Configuration Steps	CLI Commands	WebUI Procedure
traffic.	<pre>access-rule wired-port ■ (Instant AP) (Access Rule "wired-port")# rule any any match any any any permit For WLAN SSID: ■ (Instant AP) (config)# wlan access-rule guest ■ (Instant AP) (Access Rule "guest")# rule any any match any any any permit</pre>	
<p>NOTE: Ensure that you execute the commit apply command in the AOS-W Instant CLI before saving the configuration and propagating changes across the OAW-IAP cluster.</p>		

OAW-IAP-Connected Switch Configuration

Client VLANs defined in this example must be opened on the upstream switches in multiple OAW-IAP deployments, as client traffic from the slave to the master is tagged with the client VLAN.

Datacenter Configuration

For information on switch configuration, see [Configuring a switch for IAP-VPN Operations on page 317](#). Ensure that the upstream router is configured with a static route pointing to the switch for the L3 VLAN.

Scenario 3—IPsec: Multiple Datacenter Deployment with Primary and Backup switch for Redundancy

This scenario includes the following configuration elements:

- Multiple switch deployment model with switches in different data centers operating as primary or backup VPN with **Fast Failover** and preemption enabled.
- Split-tunneling of traffic.
- Split-tunneling of client DNS traffic.
- Two Distributed, L3 mode DHCPs, one each for employee and contractors; and one Local mode DHCP server.
- RADIUS server within corporate network and authentication survivability enabled for branch survivability.
- Wired and wireless users in L3 and NAT modes, respectively.
- Access rules for wired and wireless users with source-NAT-based rule for contractor roles to bypass global routing profile.
- OSPF based route propagation on switch.

Topology

Figure 13 shows the topology and the IP addressing scheme used in this scenario.

Figure 13 Scenario 3—IPsec: Multiple Datacenter Deployment with Primary and Backup switch for Redundancy

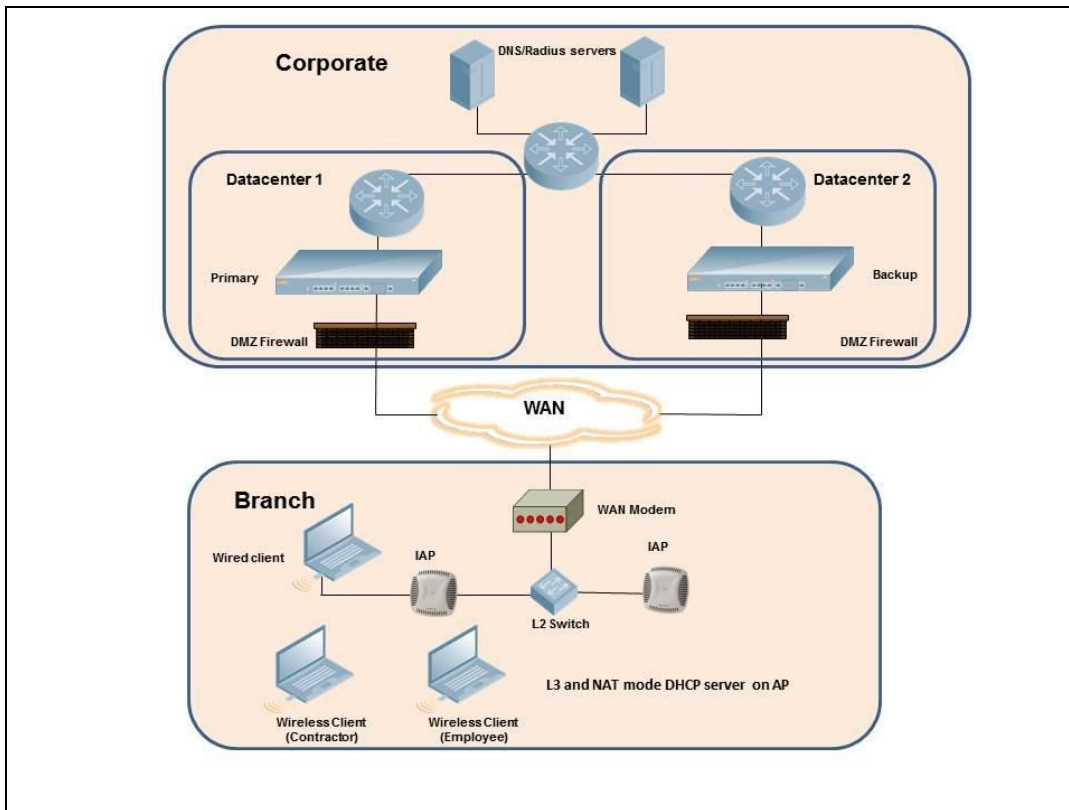

The IP addressing scheme used in this example is as follows:

- 10.0.0.0/8 is the corporate network.
- 10.30.0.0/16 subnet is reserved for L3 mode –used by Employee SSID.
- 10.40.0.0/16 subnet is reserved for L3 mode –used by Contractor SSID.
- 172.16.20.0/24 subnet is used for NAT mode – used for wired network.
- Client count in each branch is 200.
- Contractors are only permitted to reach 10.16.0.0/16 network.

OAW-IAP Configuration

This section provides information on configuration steps performed through the CLI and the UI.

Table 80: OAW-IAP Configuration for Scenario 3—IPsec: Multiple Datacenter Deployment

Configuration Steps	CLI Commands	WebUI Procedure
<p>1. Configure the primary IP address. This IP address is the Public IP address of the switch. Fast Failover is enabled for fast convergence.</p>	<ul style="list-style-type: none"> ■ (Instant AP) (config)# vpn primary <public IP of primary switch> ■ (Instant AP) (config)# vpn backup <public IP of backup switch> ■ (Instant AP) (config)# vpn preemption ■ (Instant AP) (config)# vpn fast-failover 	<p>See Configuring an IPsec Tunnel</p>
<p>2. Configure routing profiles to tunnel traffic through IPsec.</p>	<ul style="list-style-type: none"> ■ (Instant AP) (config)# routing-profile ■ (Instant AP) (routing-profile)# route 0.0.0.0 0.0.0.0 <public IP of primary switch> ■ (Instant AP) (routing-profile)# route 10.0.0.0 255.0.0.0 <public IP of backup switch> 	<p>See Configuring Routing Profiles</p>
<p>3. Configure Enterprise DNS for split DNS. The example in the next column uses a specific enterprise domain to tunnel all DNS queries matching that domain to corporate.</p>	<ul style="list-style-type: none"> ■ (Instant AP) (config)# internal-domains ■ (Instant AP) (domains)# domain-name corpdomain.com 	<p>See Configuring Enterprise Domains</p>
<p>4. Configure Distributed, L3 DHCP profiles with VLAN 30 and VLAN 40.</p>	<p>Distributed, L3 profile with VLAN 30</p> <ul style="list-style-type: none"> ■ (Instant AP) (config)# ip dhcp l3-dhcp ■ (Instant AP) (DHCP profile "l3-dhcp")# server-type Distributed,L3 ■ (Instant AP) (DHCP profile "l3-dhcp")# server-vlan 30 ■ (Instant AP) (DHCP profile "l3-dhcp")# ip-range 10.30.0.0 10.30.255.255 ■ (Instant AP) (DHCP profile "l3-dhcp")# dns-server 10.1.1.50,10.1.1.30 ■ (Instant AP) (DHCP profile "l3-dhcp")# domain-name corpdomain.com ■ (Instant AP) (DHCP profile "l3-dhcp")# client-count 200 <p>Distributed, L3 profile with VLAN 40</p> <ul style="list-style-type: none"> ■ (Instant AP) (config)# ip dhcp l3-dhcp ■ (Instant AP) (DHCP profile "l3-dhcp")# server-type Distributed,L3 ■ (Instant AP) (DHCP profile "l3- 	<p>See Configuring Distributed DHCP Scopes and Configuring Local DHCP Scopes</p>

Table 80: OAW-IAP Configuration for Scenario 3—IPsec: Multiple Datacenter Deployment

Configuration Steps	CLI Commands	WebUI Procedure
	<pre> dhcp")# server-vlan 40 ■ (Instant AP) (DHCP profile "13-dhcp")# ip-range 10.40.0.0 10.40.255.255 ■ (Instant AP) (DHCP profile "13-dhcp")# dns-server 10.1.1.50,10.1.1.30 ■ (Instant AP) (DHCP profile "13-dhcp")# domain-name corpdomain.com ■ (Instant AP) (DHCP profile "13-dhcp")# client-count 200 Local profile with VLAN 20 ■ (Instant AP) (config)# ip dhcp local ■ (Instant AP) (DHCP profile "local")# server-type Local ■ (Instant AP) (DHCP profile "local")# server-vlan 20 ■ (Instant AP) (DHCP profile "local")# subnet 172.16.20.1 ■ (Instant AP) (DHCP profile "local")# subnet-mask 255.255.255.0 ■ (Instant AP) (DHCP profile "local")# lease-time 86400 ■ (Instant AP) (DHCP profile "local")# dns-server 10.1.1.30,10.1.1.50 ■ (Instant AP) (DHCP profile "local")# domain-name arubanetworks.com The IP range configuration on each branch will be the same. Each OAW-IAP will derive a smaller subnet based on the client count scope using the BID allocated by the switch. </pre>	
<p>5. Create authentication servers for user authentication. The example in the next column assumes 802.1X SSID.</p>	<pre> ■ (Instant AP) (config)# wlan auth-server server1 ■ (Instant AP) (Auth Server "server1")# ip 10.2.2.1 ■ (Instant AP) (Auth Server "server1")# port 1812 ■ (Instant AP) (Auth Server "server1")# acctport 1813 ■ (Instant AP) (Auth Server "server1")# key "presharedkey" ■ (Instant AP) (Auth Server "server1")# exit ■ (Instant AP) (config)# wlan </pre>	<p>See Configuring an External Server for Authentication</p>

Table 80: OAW-IAP Configuration for Scenario 3—IPsec: Multiple Datacenter Deployment

Configuration Steps	CLI Commands	WebUI Procedure
	<pre>auth-server server2 ■ (Instant AP) (Auth Server "server1")# ip 10.2.2.2 ■ (Instant AP) (Auth Server "server1")# port 1812 ■ (Instant AP) (Auth Server "server1")# acctport 1813 ■ (Instant AP) (Auth Server "server1")# key "presharedkey"</pre>	
<p>6. Configure wired port and wireless SSIDs using the authentication servers and access rules; enable authentication survivability.</p>	<p>Configure wired ports to operate in NAT mode and associate VLAN 20 to the wired port profile.</p> <pre>■ (Instant AP) (config) # wired-port-profile wired-port ■ (Instant AP) (wired-port-profile "wired-port")# switchport-mode access ■ (Instant AP) (wired-port-profile "wired-port")# allowed-vlan all ■ (Instant AP) (wired-port-profile "wired-port")# native-vlan 20 ■ (Instant AP) (wired-port-profile "wired-port")# no shutdown ■ (Instant AP) (wired-port-profile "wired-port")# access-rule-name wired-port ■ (Instant AP) (wired-port-profile "wired-port")# type employee ■ (Instant AP) (wired-port-profile "wired-port")# auth-server server1 ■ (Instant AP) (wired-port-profile "wired-port")# auth-server server2 ■ (Instant AP) (wired-port-profile "wired-port")# dot1x ■ (Instant AP) (wired-port-profile "wired-port")# exit ■ (Instant AP) (config)# enet1-port-profile wired-port</pre> <p>Configure a wireless SSID to operate in L3 mode for employee and associate Distributed, L3 mode VLAN 30 to the WLAN SSID profile.</p> <pre>■ (Instant AP) (config) # wlan ssid-profile wireless-ssid</pre>	<p>See Configuring a Wired Profile and Wireless Network Profiles</p>

Table 80: OAW-IAP Configuration for Scenario 3—IPsec: Multiple Datacenter Deployment

Configuration Steps	CLI Commands	WebUI Procedure
	<ul style="list-style-type: none"> ■ (Instant AP) (SSID Profile "wireless-ssid")# enable ■ (Instant AP) (SSID Profile "wireless-ssid")# type employee ■ (Instant AP) (SSID Profile "wireless-ssid")# essid wireless-ssid ■ (Instant AP) (SSID Profile "wireless-ssid")# opmode wpa2-aes ■ (Instant AP) (SSID Profile "wireless-ssid")# vlan 30 ■ (Instant AP) (SSID Profile "wireless-ssid")# auth-server server1 ■ (Instant AP) (SSID Profile "wireless-ssid")# auth-server server2 ■ (Instant AP) (SSID Profile "wireless-ssid")# auth-survivability <p>Configure a wireless SSID to operate in L3 mode for contractor and associate Distributed, L3 mode VLAN 40 to the WLAN SSID profile.</p> <ul style="list-style-type: none"> ■ (Instant AP) (config) # wlan ssid-profile wireless-ssid-contractor ■ (Instant AP) (SSID Profile "wireless-ssid-contractor")# enable ■ (Instant AP) (SSID Profile "wireless-ssid-contractor")# type contractor ■ (Instant AP) (SSID Profile "wireless-ssid-contractor")# essid wireless-ssid-contractor ■ (Instant AP) (SSID Profile "wireless-ssid-contractor")# opmode wpa2-aes ■ (Instant AP) (SSID Profile "wireless-ssid-contractor")# vlan 40 ■ (Instant AP) (SSID Profile "wireless-ssid-contractor")# auth-server server1 ■ (Instant AP) (SSID Profile "wireless-ssid-contractor")# auth-server server2 ■ (Instant AP) (SSID Profile 	

Table 80: OAW-IAP Configuration for Scenario 3—IPsec: Multiple Datacenter Deployment

Configuration Steps	CLI Commands	WebUI Procedure
	<pre>"wireless-ssid-contractor")# auth-survivability</pre>	
<p>7. Create access rule for wired and wireless authentication. In this example, the rule permits all traffic. For contractor SSID role, the rule allows only 10.16.0.0/16 network and all other traffic address is translated at the source and the global routing profile definition is bypassed.</p>	<p>For wired profile:</p> <ul style="list-style-type: none"> ■ (Instant AP) (config)# wlan access-rule wired-port ■ (Instant AP) (Access Rule "wired-port")# rule any any match any any any permit <p>For WLAN SSID employee roles:</p> <ul style="list-style-type: none"> ■ (Instant AP) (config)# wlan access-rule wireless-ssid ■ (Instant AP) (Access Rule "wireless-ssid")# rule any any match any any any permit <p>For WLAN SSID contractor roles:</p> <ul style="list-style-type: none"> ■ (Instant AP) (config)# wlan access-rule wireless-ssid-contractor ■ (Instant AP) (Access Rule "wireless-ssid-contractor")# rule 10.16.0.0 255.255.0.0 match any any any permit ■ (Instant AP) (Access Rule "wireless-ssid-contractor")# rule any any match any any any src-nat 	<p>See Configuring ACL Rules for Network Services</p>
<p>NOTE: Ensure that you execute the commit apply command in the AOS-W Instant CLI before saving the configuration and propagating changes across the OAW-IAP cluster.</p>		

OAW-IAP-Connected Switch Configuration

Client VLANs defined in this example must be opened on the upstream switches in multiple OAW-IAP deployments, as client traffic from the slave to the master is tagged with the client VLAN.

Datacenter Configuration

For information on switch configuration, see [Configuring a switch for IAP-VPN Operations on page 317](#).

The following OSPF configuration is required on the switch to redistribute IAP-VPN routes to upstream routers:

```
(host) (config) # router ospf
(host) (config) # router ospf router-id <ID>
(host) (config) # router ospf area 0.0.0.0
(host) (config) # router ospf redistribute rapng-vpn
```

Scenario 4—GRE: Single Datacenter Deployment with No Redundancy

This scenario includes the following configuration elements:

- Single VPN primary configuration using GRE
 - **Aruba GRE**, does not require any configuration on the OmniAccess Mobility Controller that acts as a GRE endpoint.

- **Manual GRE**, which requires GRE tunnels to be explicitly configured on the GRE endpoint that can be an OmniAccess Mobility Controller or any device that supports GRE termination.
- Tunneling of all traffic to datacenter
- Centralized, L2 mode DHCP profile
- RADIUS server within corporate network and authentication survivability for branch survivability.
- Wired and wireless users in L2 mode
- Access rules defined for wired and wireless networks to permit all traffic

Topology

[Figure 14](#) shows the topology and the IP addressing scheme used in this scenario:

Figure 14 Scenario 4—GRE: Single Datacenter Deployment with No Redundancy

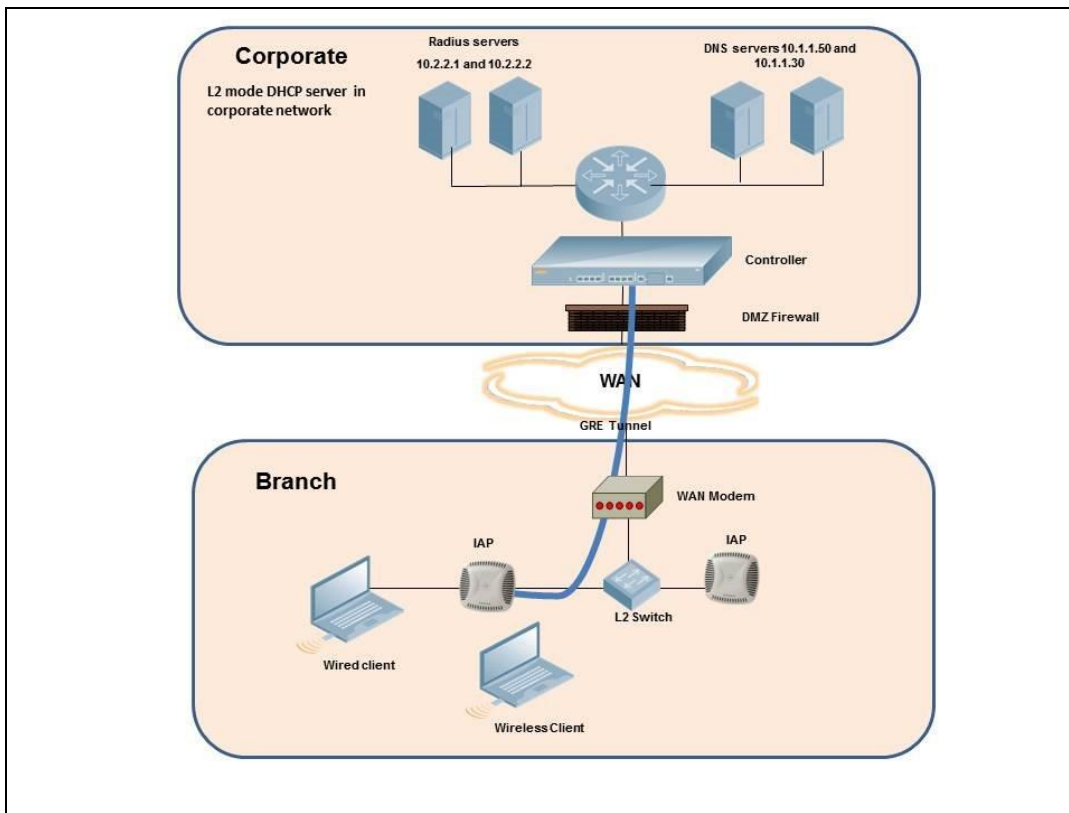

The following IP addresses are used in the examples for this scenario:

- 10.0.0.0/8 is the corporate network.
- 10.20.0.0/16 subnet is reserved for L2 mode.

OAW-IAP Configuration

This section provides information on configuration steps performed by using the CLI and the UI.

Table 81: OAW-IAP Configuration for Scenario 4—GRE: Single Datacenter Deployment with No Redundancy

Configuration Steps	CLI Commands	WebUI Procedure
<p>1. Configure Aruba GRE or manual GRE</p> <ul style="list-style-type: none"> Aruba GRE uses an IPsec tunnel to facilitate switch configuration and requires VPN to be configured. This VPN tunnel is not used for any client traffic. Manual GRE uses standard GRE tunnel configuration and requires switch configuration to complete the GRE tunnel. 	<p>Aruba GRE configuration</p> <ul style="list-style-type: none"> (Instant AP) (config)# vpn primary <switch-IP> (Instant AP) (config)# vpn gre-outside <p>Manual GRE configuration</p> <ul style="list-style-type: none"> (Instant AP) (config)# gre primary <switch-IP> (Instant AP) (config)# gre type 80 <p>Per-AP GRE tunnel configuration</p> <p>Optionally, per-AP GRE tunnel can also be enabled, which causes each OAW-IAP to form an independent GRE tunnel to the GRE endpoint. Aruba GRE requires each OAW-IAP MAC to be present in the switch whitelist. Manual GRE requires GRE configuration for the IP of each OAW-IAP on the switch.</p> <ul style="list-style-type: none"> (Instant AP) (config)# gre per-ap-tunnel <p>NOTE: If a virtual switch IP is configured and per-AP GRE tunnel is disabled, OAW-IAP uses virtual switch IP as the GRE source IP. For Manual GRE, this simplifies configuration on switch, since only the virtual switch IP destined GRE tunnel interface configuration is required.</p>	<p>See Configuring Aruba GRE Parameters and Configuring Manual GRE Parameters</p>
<p>2. Configure routing profiles to tunnel traffic through GRE.</p>	<ul style="list-style-type: none"> (Instant AP) (config)# routing-profile (Instant AP) (routing-profile)# route 0.0.0.0 0.0.0.0 <IP of GRE-endpoint> 	<p>See Configuring Routing Profiles</p>
<p>3. Configure Enterprise DNS. The example in the next column tunnels all DNS queries to the client's original DNS server without proxying on OAW-IAP.</p>	<ul style="list-style-type: none"> (Instant AP) (config)# internal-domains (Instant AP) (domains)# domain-name * 	<p>See Configuring Enterprise Domains</p>
<p>4. Configure Centralized, L2 DHCP profile with VLAN 20.</p>	<p>Centralized, L2 DHCP profile VLAN 20</p> <ul style="list-style-type: none"> (Instant AP) (config)# ip dhcp l2-dhcp (Instant AP) (DHCP profile "l2-dhcp")# server-type Centralized,L2 (Instant AP) (DHCP profile "l2-dhcp")# server-vlan 20 	<p>See Enabling DHCP Relay Agent Information Option (Option 82)</p>

Table 81: OAW-IAP Configuration for Scenario 4—GRE: Single Datacenter Deployment with No Redundancy

Configuration Steps	CLI Commands	WebUI Procedure
<p>5. Create authentication servers for user authentication. The example in the next column assumes 802.1X SSID.</p>	<ul style="list-style-type: none"> ■ (Instant AP) (config)# wlan auth-server server1 ■ (Instant AP) (Auth Server "server1")# ip 10.2.2.1 ■ (Instant AP) (Auth Server "server1")# port 1812 ■ (Instant AP) (Auth Server "server1")# acctport 1813 ■ (Instant AP) (Auth Server "server1")# key "presharedkey" ■ (Instant AP) (Auth Server "server1")# exit ■ (Instant AP) (config)# wlan auth-server server2 ■ (Instant AP) (Auth Server "server1")# ip 10.2.2.2 ■ (Instant AP) (Auth Server "server1")# port 1812 ■ (Instant AP) (Auth Server "server1")# acctport 1813 ■ (Instant AP) (Auth Server "server1")# key "presharedkey" 	<p>See Configuring an External Server for Authentication</p>
<p>6. Configure wired and wireless SSIDs using the authentication servers and access rules; enable authentication survivability.</p>	<p>Configure wired ports to operate in Centralized, L2 mode and associate VLAN 20 to the wired port profile.</p> <ul style="list-style-type: none"> ■ (Instant AP) (config) # wired-port-profile wired-port ■ (Instant AP) (wired-port-profile "wired-port")# switchport-mode access ■ (Instant AP) (wired-port-profile "wired-port")# allowed-vlan all ■ (Instant AP) (wired-port-profile "wired-port")# native-vlan 20 ■ (Instant AP) (wired-port-profile "wired-port")# no shutdown ■ (Instant AP) (wired-port-profile "wired-port")# access-rule-name wired-port ■ (Instant AP) (wired-port-profile "wired-port")# type employee ■ (Instant AP) (wired-port-profile "wired-port")# auth-server server1 ■ (Instant AP) (wired-port-profile "wired-port")# auth-server server2 ■ (Instant AP) (wired-port-profile "wired-port")# dot1x ■ (Instant AP) (wired-port-profile "wired-port")# exit 	<p>See Configuring a Wired Profile and Wireless Network Profiles</p>

Table 81: OAW-IAP Configuration for Scenario 4—GRE: Single Datacenter Deployment with No Redundancy

Configuration Steps	CLI Commands	WebUI Procedure
	<ul style="list-style-type: none"> ■ (Instant AP) (config) # enet1-port-profile wired-port <p>Configure a wireless SSID to operate in Centralized, L2 mode and associate VLAN 20 to the WLAN SSID profile.</p> <ul style="list-style-type: none"> ■ (Instant AP) (config) # wlan ssid-profile wireless-ssid ■ (Instant AP) (SSID Profile "wireless-ssid") # enable ■ (Instant AP) (SSID Profile "wireless-ssid") # type employee ■ (Instant AP) (SSID Profile "wireless-ssid") # essid wireless-ssid ■ (Instant AP) (SSID Profile "wireless-ssid") # opmode wpa2-aes ■ (Instant AP) (SSID Profile "wireless-ssid") # vlan 20 ■ (Instant AP) (SSID Profile "wireless-ssid") # auth-server server1 ■ (Instant AP) (SSID Profile "wireless-ssid") # auth-server server2 ■ (Instant AP) (SSID Profile "wireless-ssid") # auth-survivability 	
7. Create access rule for wired and wireless authentication.	<p>For wired profile:</p> <ul style="list-style-type: none"> ■ (Instant AP) (config) # wlan access-rule wired-port ■ (Instant AP) (Access Rule "wired-port") # rule any any match any any any permit <p>For WLAN SSID employee roles:</p> <ul style="list-style-type: none"> ■ (Instant AP) (config) # wlan access-rule wireless-ssid ■ (Instant AP) (Access Rule "wireless-ssid") # rule any any match any any any permit 	See Configuring ACL Rules for Network Services
<p>NOTE: Ensure that you execute the commit apply command in the AOS-W Instant CLI before saving the configuration and propagating changes across the OAW-IAP cluster.</p>		

OAW-IAP-Connected Switch Configuration

Client VLANs defined in this example must be opened on the upstream switches in multiple OAW-IAP deployments, as client traffic from the slave to the master is tagged with the client VLAN.

Datacenter Configuration

For information on switch configuration, see [Configuring a switch for IAP-VPN Operations on page 317](#).

The following GRE configuration is required on the switch:

```
(host)(config)# interface tunnel <Number>
(host)(config-tunnel)# description <Description>
(host)(config-tunnel)# tunnel mode gre <ID>
(host)(config-tunnel)# tunnel source <controller-IP>
(host)(config-tunnel)# tunnel destination <AP-IP>
(host)(config-tunnel)# trusted
(host)(config-tunnel)# tunnel vlan <allowed-VLAN>
```

This chapter provides the following information:

- [ARM Overview on page 344](#)
- [Configuring ARM Features on an OAW-IAP on page 345](#)
- [Configuring Radio Settings on page 354](#)

ARM Overview

ARM is an RF management technology that optimizes WLAN performance even in networks with the highest traffic by dynamically and intelligently choosing the best 802.11 channel and transmitting power for each OAW-IAP in its current RF environment. ARM works with all standard clients, across all operating systems, while remaining in compliance with the IEEE 802.11 standards. It does not require any proprietary client software to achieve its performance goals. ARM ensures low-latency roaming, consistently high performance, and maximum client compatibility in a multi-channel environment. By ensuring a fair distribution of the available Wi-Fi bandwidth to mobile devices, ARM ensures that data, voice, and video applications have sufficient network resources at all times. ARM allows mixed 802.11a, 802.11b, 802.11g, 802.11n, and 802.11ac client types to interoperate at the highest performance levels.

Channel or Power Assignment

The channel or power assignment feature automatically assigns channel and power settings for all the OAW-IAPs in the network according to changes in the RF environment. This feature automates many setup tasks during network installation and the ongoing operations when RF conditions change.

Voice Aware Scanning

The Voice Aware scanning feature prevents an OAW-IAP supporting an active voice call from scanning for other channels in the RF spectrum and allows the OAW-IAP to resume scanning when there are no active voice calls. This significantly improves the voice quality when a call is in progress and simultaneously delivers the automated RF management functions. By default, this feature is enabled.

Load Aware Scanning

The Load Aware Scanning feature dynamically adjusts scanning function to maintain uninterrupted data transfer on resource-intensive systems when the network traffic exceeds a predefined threshold. The OAW-IAPs resume complete monitoring scans when the traffic drops to the normal levels. By default, this feature is enabled.

Monitoring the Network with ARM

When ARM is enabled, an OAW-IAP dynamically scans all 802.11 channels within its 802.11 regulatory domain at regular intervals and sends reports to a virtual switch on WLAN network coverage, interference, and intrusion detection.

ARM Metrics

ARM computes coverage and interference metrics for each valid channel and chooses the best performing channel and transmit power settings for each OAW-IAP RF environment. Each OAW-IAP gathers other metrics on its ARM-assigned channel to provide a snapshot of the current RF health state.

Configuring ARM Features on an OAW-IAP

This section describes the following procedures for configuring ARM features:

- [Band Steering on page 345](#)
- [Airtime Fairness Mode on page 346](#)
- [Client Match on page 347](#)
- [Access Point Control on page 350](#)

Band Steering

The band steering feature assigns the dual-band capable clients to the 5 GHz band on dual-band OAW-IAPs. This feature reduces co-channel interference and increases available bandwidth for dual-band clients, because there are more channels on the 5 GHz band than that on the 2.4 GHz band. You can configure band steering parameters through the WebUI or the CLI.

In the Old WebUI

To configure band steering:

1. Go to **RF > ARM**.
2. Select one of the following options from the **Band steering mode** drop-down list:

Table 82: *Band Steering Mode—Configuration Parameters*

Parameter	Description
Prefer 5 Ghz	Select this option to use band steering in the 5 GHz mode. On selecting this, the OAW-IAP steers the client to the 5 GHz band (if the client is 5 GHz-capable), but allows the client connection on the 2.4 GHz band if the client persistently attempts for 2.4 GHz association.
Force 5 Ghz	Select this option to enforce 5 GHz band steering mode on the OAW-IAPs.
Balance Bands	Select this option to allow the OAW-IAP to balance the clients across the two radios to best utilize the available 2.4 GHz bandwidth. This feature takes into account the fact that the 5 GHz band has more channels than the 2.4 GHz band, and that the 5 GHz channels operate in 40 MHz, while the 2.4 GHz band operates in 20 MHz.
Disabled	Select this option if you want to allow the clients to select the band to use.

3. Click **OK**.

In the New WebUI

To configure band steering:

1. Navigate to the **Configuration > RF** page.
2. Expand **ARM**.
3. Select one of the following options from the **Band steering mode** drop-down list:

Table 83: Band Steering Mode—Configuration Parameters

Parameter	Description
Prefer 5 Ghz	Select this option to use band steering in the 5 GHz mode. On selecting this, the OAW-IAP steers the client to the 5 GHz band (if the client is 5 GHz-capable), but allows the client connection on the 2.4 GHz band if the client persistently attempts for 2.4 GHz association.
Force 5 Ghz	Select this option to enforce 5 GHz band steering mode on the OAW-IAPs.
Balance Bands	Select this option to allow the OAW-IAP to balance the clients across the two radios to best utilize the available 2.4 GHz bandwidth. This feature takes into account the fact that the 5 GHz band has more channels than the 2.4 GHz band, and that the 5 GHz channels operate in 40 MHz, while the 2.4 GHz band operates in 20 MHz.
Disabled	Select this option if you want to allow the clients to select the band to use.

4. Click **Save**.

In the CLI

To configure band steering:

```
(Instant AP) (config)# arm
(Instant AP) (ARM)# band-steering-mode {<Prefer 5 GHz>| <Force 5 GHz>|<Balance
Bands>|<Disabled>}
```

Airtime Fairness Mode

The airtime fairness feature provides equal access to all clients on the wireless medium, regardless of client type, capability, or operating system, thus delivering uniform performance to all clients. This feature prevents the clients from monopolizing resources. You can configure airtime fairness mode parameters through the WebUI or the CLI.

In the Old WebUI

To configure Airtime fairness mode:

1. Go to **RF > ARM > Show advanced options**.
2. Select one of the following options from the **Airtime fairness mode** drop-down list.

Table 84: Airtime Fairness Mode—Configuration Parameters

Parameter	Description
Default Access	Select this option to provide access based on client requests. When Air Time Fairness is set to default access, per-user and per-SSID bandwidth limits are not enforced.
Fair Access	Select this option to allocate Airtime evenly across all the clients.
Preferred Access	Select this option to set a preference where 802.11n clients are assigned more airtime than 802.11a or 802.11g. The 802.11a or 802.11g clients get more airtime than 802.11b. The ratio is 16:4:1.

3. Click **OK**.

In the New WebUI

To configure Airtime fairness mode:

1. Navigate to the **Configuration > RF** page.

2. Expand **ARM**.
3. Select one of the following options from the **Airtime fairness mode** drop-down list.

Table 85: Airtime Fairness Mode—Configuration Parameters

Parameter	Description
Default Access	Select this option to provide access based on client requests. When Air Time Fairness is set to default access, per-user and per-SSID bandwidth limits are not enforced.
Fair Access	Select this option to allocate Airtime evenly across all the clients.
Preferred Access	Select this option to set a preference where 802.11n clients are assigned more airtime than 802.11a or 802.11g. The 802.11a or 802.11g clients get more airtime than 802.11b. The ratio is 16:4:1.

4. Click **Save**.

In the CLI

```
(Instant AP) (config)# arm
(Instant AP) (ARM)# air-time-fairness-mode {<Default Access>| <Fair Access> | <Preferred
Access>
```

Client Match

The ARM client match feature continually monitors a client's RF neighborhood to provide ongoing client band steering and load balancing, and enhanced OAW-IAP reassignment for roaming mobile clients. This feature supersedes the legacy band steering and spectrum load balancing features, which unlike client match, do not trigger OAW-IAP changes for clients already associated to an OAW-IAP. In addition to this, the Client Match feature provides the smartphone handoff assist function which helps smartphones to switch between 3G and 4G networks when the Wi-Fi connectivity is poor. The OAW-IAP monitors the RSSI of the smartphone and checks if it remains under the threshold connectivity strength for a certain duration and deauthenticates the client.



Legacy 802.11a, 802.11b, or 802.11g access points do not support the client match feature. When client match is enabled on 802.11n-capable access points, the client match feature overrides any settings configured for the legacy band steering, station handoff assist, or load balancing feature. 802.11ac-capable access points do not support the legacy band steering, station handoff assist, or load balancing settings; so these access points must be managed using client match.

When the client match feature is enabled on an OAW-IAP, the OAW-IAP measures the RF health of its associated clients. In the current release, the client match feature is supported only within an OAW-IAP cluster. If any of the following trigger conditions is met, clients are moved from one OAW-IAP to another for better performance and client experience:

- **Dynamic Load Balancing**—Client match balances clients across OAW-IAPs on different channels, based on the client load on the OAW-IAPs and the SNR levels the client detects from an underutilized OAW-IAP. If an OAW-IAP radio can support additional clients, the OAW-IAP will participate in client match load balancing and clients can be directed to that OAW-IAP radio, subject to the predefined SNR thresholds. For better load balancing, clients are steered from busy channels to idle channels.
- **Sticky Clients**—The client match feature also helps mobile clients that tend to stay associated to an OAW-IAP despite low signal levels. OAW-IAPs using client match continually monitor the client's RSSI as the client roams between OAW-IAPs, and move the client to an OAW-IAP when a better radio match can be found. This prevents mobile clients from remaining associated to the OAW-IAPs with less than ideal RSSI, which can cause poor connectivity and reduce performance for other clients associated with that OAW-IAP.

- **Band Steering**—OAW-IAPs using the client match feature monitor the RSSI for clients that advertise a dual-band capability. If a client is currently associated to a 2.4 GHz radio and the OAW-IAP detects that the client has a good RSSI from the 5 GHz radio, the OAW-IAP steers the client to the 5 GHz radio, as long as the 5 GHz RSSI is not significantly worse than the 2.4 GHz RSSI, and the OAW-IAP retains a suitable distribution of clients on each of its radios.
- **Channel Utilization**—Based on the percentage of channel utilization, clients are steered from a busy channel to an idle channel.
- **Client Capability Match**—Based on the client capability match, clients are steered to appropriate channel, for example, HT20, HT40, or VHT80.



Starting from the Instant 6.3.1.1-4.0 release, spectrum load balancing is integrated with the client match feature. Client match allows the OAW-IAPs in a cluster to be divided into several logical OAW-IAP RF neighborhood called domains, which share the same clients. The network determines the distribution of clients and balances client load across channels, regardless of whether the OAW-IAP is responding to the probe requests of wireless clients.

Client Match Support for Standalone OAW-IAPs

Previously, client match keys were generated by the virtual switch key to differentiate whether or not OAW-IAPs belonged to the same cluster. If the client match keys did not match, client match functionality failed to take effect on standalone OAW-IAPs within the same management VLAN.

AOS-W Instant 8.4.0.0 supports the client match functionality across standalone OAW-IAPs within the same management VLAN. Client match uses the wired layer 2 protocol to synchronize information exchanged between OAW-IAPs. Users have an option to configure the client match keys. OAW-IAPs verify if the frames that they broadcast contain a common client match key. OAW-IAPs that receive these frames verify if the sender belongs to same network or if the sender and receiver both have the same client match key. The receiver adds the sender's information to the client match scope. After the sender's information is added, the client match functionality takes effect for standalone OAW-IAPs as well.

You can configure client match parameters in the WebUI or the CLI. When client match is enabled, the dashboard in the main window displays the **Client Match** link on selecting an OAW-IAP in the **Access Points** tab or a client in the **Clients** tab. Clicking this link provides a graphical representation of radio map view of an OAW-IAP and the client distribution on an OAW-IAP radio. For more information, see [Client Match on page 49](#).

In the Old WebUI

1. For client match configuration, specify the following parameters in the **RF > ARM > Show advanced options** tab:

Table 86: Client Match Configuration Parameters

Parameter	Description
Client match	Select Enabled to enable the Client match feature on OAW-IAPs. When enabled, client count will be balanced among all the channels in the same band. For more information, see ARM Overview on page 344 . By default, the client match feature is disabled. NOTE: When client match is enabled, ensure that Scanning is enabled.
CM calculating interval	Specify a value for calculating the interval of Client match. The value specified for CM calculating interval determines the interval at which client match is calculated. The interval is specified in seconds and the default value is 30 seconds. You can specify a value within the range of 10–600.
CM neighbor matching %	Specify a value for CM neighbor matching % . This number takes into account the least similarity percentage to be considered as in the same virtual RF neighborhood of client match. You can specify a percentage value within the range of 20–100. The default value is 60%.
CM threshold	Specify a value for CM threshold . This number takes acceptance client count difference among all the channels of client match into account. When the client load on an OAW-IAP reaches or exceeds the threshold, client match is enabled on that OAW-IAP. You can specify a value within range of 1–255. The default value is 2.
SLB mode	Select a mode from the SLB mode drop-down list. The SLB mode determines the balancing strategy for client match. The following options are available: <ul style="list-style-type: none"> ■ Channel ■ Radio ■ Channel + Radio

2. Click **OK**.

In the New WebUI

1. For client match configuration, specify the following parameters in **Configuration > RF > ARM > Show advanced options**:

Table 87: Client Match Configuration Parameters

Parameter	Description
Client match	Click the toggle switch to enable the Client match feature on OAW-IAPs. When enabled, client count will be balanced among all the channels in the same band. For more information, see ARM Overview on page 344 . By default, the client match feature is disabled. NOTE: When client match is enabled, ensure that Scanning is enabled.
CM calculating interval	Specify a value for calculating the interval of Client match. The value specified for CM calculating interval determines the interval at which client match is calculated. The interval is specified in seconds and the default value is 30 seconds. You can specify a value within the range of 10–600.
CM neighbor matching %	Specify a value for CM neighbor matching % . This number takes into account the least similarity percentage to be considered as in the same virtual RF neighborhood of client match. You can specify a percentage value within the range of 20–100. The default value is 60%.
CM threshold	Specify a value for CM threshold . This number takes acceptance client count difference among all the channels of client match into account. When the client load on anOAW-IAP reaches or exceeds the threshold, client match is enabled on that OAW-IAP.

Table 87: Client Match Configuration Parameters

Parameter	Description
	You can specify a value within range of 1–255. The default value is 2.
CM key	Specify a client match key in CM key . When OAW-IAPs in a different cluster configure the same client match key, the client match functionality works for these OAW-IAPs. NOTE: This parameter is not available in the old WebUI.
SLB mode	Select a mode from the SLB mode drop-down list. The SLB mode determines the balancing strategy for client match. The following options are available: <ul style="list-style-type: none"> ■ Channel ■ Radio ■ Channel + Radio

2. Click **Save**.

In the CLI

```
(Instant AP) (config)# arm
(Instant AP) (ARM)# client-match calc-interval <seconds>
(Instant AP) (ARM)# client-match calc-threshold <threshold>
(Instant AP) (ARM)# client-match nb-matching <percentage>
(Instant AP) (ARM)# client-match slb-mode 1
```

Access Point Control

You can configure access point control parameters through the WebUI or the CLI.

In the Old WebUI

1. For **Access Point Control**, specify the following parameters in the **RF > ARM > Show advanced options** tab:

Table 88: Access Point Control—Configuration Parameters

Parameter	Description
Customize valid channels	Select this check box to customize valid channels for 2.4 GHz and 5 GHz. By default, the OAW-IAP uses valid channels as defined by the Country Code (regulatory domain). On selecting the Customize valid channels check box, a list of valid channels for both 2.4 GHz and 5 GHz are displayed. The valid channel customization feature is disabled by default.
Min transmit power	Specify the minimum transmission power. The value specified for Min transmit power indicates the minimum EIRP that can range from 3 dBm to 33 dBm in 3 dBm increments. If the minimum transmission EIRP setting configured on an OAW-IAP is not supported by the OAW-IAP model, this value is reduced to the highest supported power setting. The default value for minimum transmit power is 18 dBm.
Max transmit power	Specify the maximum transmission power. The value specified for Max transmit power indicates the maximum EIRP that can range from 3 dBm to 33 dBm in 3 dBm increments. If the maximum transmission EIRP configured on an OAW-IAP is not supported by the OAW-IAP model, the value is reduced to the highest supported power setting. The default value for maximum transmit power is 127 dBm.

Table 88: Access Point Control—Configuration Parameters

Parameter	Description
Client aware	When enabled, ARM does not change channels for the OAW-IAPs with active clients, except for high-priority events such as RADAR or excessive noise. This feature must be enabled in most deployments for a stable WLAN. If the Client Aware mode is set to Disabled , the OAW-IAP may change to a more optimal channel, that may disrupt the current client traffic for a while. The Client aware option is Enabled by default. NOTE: When Client aware is disabled, channels can be changed even when the clients are active on a BSSID.
Scanning	Select Enabled so that the OAW-IAP dynamically scans all 802.11 channels within its 802.11 regulatory domain at regular intervals and reports to the OAW-IAP. This scanning report includes WLAN coverage, interference, and intrusion detection data. NOTE: For client match configuration, ensure that scanning is enabled.
Wide channel bands	Select a band to allow the OAW-IAPs to be placed in 40 MHz (wide band) channels. The Wide channel bands allows administrators to configure 40 MHz channels in the 2.4 GHz and 5 GHz bands. 40 MHz channels are two 20 MHz adjacent channels that are bonded together. A 40 MHz channel effectively doubles the frequency bandwidth available for data transmission.
80MHz support	Enables or disables the use of 80 MHz channels on OAW-IAPs. This feature allows ARM to assign 80 MHz channels on OAW-IAPs with 5 GHz radios, which support a VHT. This setting is enabled by default. NOTE: Only the OAW-IAPs that support 802.11ac can be configured with 80 MHz channels.

2. Reboot the OAW-IAP.
3. Click **OK**.

In the New WebUI

1. For **Access Point Control**, configure the following parameters in **Configuration > RF > ARM > Show advanced options**:

Table 89: Access Point Control—Configuration Parameters

Parameter	Description
Customize valid channels	Click the toggle switch based on how you want to customize valid channels for 2.4 GHz and 5 GHz. By default, the OAW-IAP uses valid channels as defined by the Country Code (regulatory domain). On enabling Customize valid channels , a list of valid channels for both 2.4 GHz and 5 GHz are displayed. The valid channel customization feature is disabled by default.
Min transmit power	Specify the minimum transmission power. The value specified for Min transmit power indicates the minimum EIRP that can range from 3 dBm to 33 dBm in 3 dBm increments. If the minimum transmission EIRP setting configured on anOAW-IAP is not supported by the OAW-IAP model, this value is reduced to the highest supported power setting. The default value for minimum transmit power is 18 dBm.
Max transmit power	Select the maximum transmission power value from the Max transmit power drop-down list indicates the maximum EIRP that can range from 3 dBm to 33 dBm in 3 dBm increments. If the maximum transmission EIRP configured on anOAW-IAP is not supported by the OAW-IAP model, the value is reduced to the highest supported power setting. The default value for maximum transmit power is 127 dBm.

Table 89: Access Point Control—Configuration Parameters

Parameter	Description
Client aware	When enabled, ARM does not change channels for the OAW-IAPs with active clients, except for high-priority events such as RADAR or excessive noise. This feature must be enabled in most deployments for a stable WLAN. If the client aware mode is disabled, the OAW-IAP may change to a more optimal channel, that may disrupt the current client traffic for a while. The client aware parameter is enabled by default. NOTE: When Client Aware is disabled, channels can be changed even when the clients are active on a BSSID.
Scanning	Click the toggle switch so that the OAW-IAP dynamically scans all 802.11 channels within its 802.11 regulatory domain at regular intervals and reports to the OAW-IAP. This scanning report includes WLAN coverage, interference, and intrusion detection data. NOTE: For client match configuration, ensure that scanning is enabled.
Wide channel bands	Select a band to allow the OAW-IAPs to be placed in 40 MHz (wide band) channels. The Wide channel bands allows administrators to configure 40 MHz channels in the 2.4 GHz and 5 GHz bands. 40 MHz channels are two 20 MHz adjacent channels that are bonded together. A 40 MHz channel effectively doubles the frequency bandwidth available for data transmission.
80MHz support	Enables or disables the use of 80 MHz channels on OAW-IAPs. This feature allows ARM to assign 80 MHz channels on OAW-IAPs with 5 GHz radios, which support a VHT. This setting is enabled by default. NOTE: Only the OAW-IAPs that support 802.11ac can be configured with 80 MHz channels.

2. Click **Save**.
3. Reboot the OAW-IAP.

In the CLI

To configure access point control parameters:

```
(Instant AP) (config)# arm
(Instant AP) (ARM)# a-channels <5GHz-channels>
(Instant AP) (ARM)# min-tx-power <power>
(Instant AP) (ARM)# max-tx-power <power>
(Instant AP) (ARM)# client-aware
(Instant AP) (ARM)# wide-bands {<5GHz>|<2GHz>|<All>|<None>}
(Instant AP) (ARM)# scanning
(Instant AP) (ARM)# 80mhz-support
```

Verifying ARM Configuration

To view ARM configuration:

```
(Instant AP)# show arm config

Minimum Transmit Power           :18
Maximum Transmit Power           :127
Band Steering Mode                :prefer-5ghz
Client Aware                      :enable
Scanning                          :enable
Wide Channel Bands                :5ghz
80Mhz Support                     :enable
Air Time Fairness Mode            :fair-access
Client Match                      :disable
CM NB Matching Percent            :75
CM Calculating Interval           :30
CM SLB Threshold                  :2
CM SLB Balancing Mode             :channel based
```



```

CM max client match req :5
CM max adoption         :5
Custom Channels         :No

```

2.4 GHz Channels

Channel	Status
1	enable
2	disable
3	disable
4	disable
5	disable
6	enable
7	disable
8	disable
9	disable
10	disable
11	enable
12	disable
13	disable
1+	enable
2+	disable
3+	disable
4+	disable
5+	disable
6+	disable
7+	enable

5.0 GHz Channels

Channel	Status
36	enable
40	enable
44	enable
48	enable
52	enable
56	enable
60	enable
64	enable
149	enable
153	enable
157	enable
161	enable
165	enable
36+	enable
44+	enable
52+	disable
60+	disable
149+	enable
157+	enable
36E	enable
52E	enable
149E	enable

Client Match for Access Points in a Zone

When Client match is enabled, the decision to move a client from the home OAW-IAP to a target OAW-IAP is made at the radio level. However, this proves inefficient when client match is enabled on an OAW-IAP or SSID operating in a specific zone, it could result in the client being moved to a target OAW-IAP that does not have the same zone specific SSID as the home OAW-IAP.

Starting from AOS-W Instant 6.5.1.0-4.3.1.0, the decision to move a client from a home OAW-IAP to a target OAW-IAP will be made at the SSID level instead of the radio level, by adding the SSID name to the client match radio database. Client Match will check if the same SSID (zone specific SSID on Home OAW-IAP) is available on the target OAW-IAP before it moves the client. This ensures that client match works as expected when zone settings are configured on the OAW-IAP.

Additionally, the maximum clients threshold and the current associated client number of the SSID is added to the client match radio database to prevent the clients from being moved to an SSID whose associated client number is already reached its limit.

You can use the following commands to view the SSID details stored in client match:

The **show ap client-match-ssid-table** command displays the client match SSID table for the current OAW-IAP and its neighboring OAW-IAPs.

The **show ap client-match-ssid-table radio-mac <mac>** command displays the client match SSID table for a specific OAW-IAP denoted by its mac address.

Configuring Radio Settings

The current Radio profile is displayed as **Default**. The default profile cannot be deleted. You can configure 2.4 GHz and 5 GHz radio settings for an OAW-IAP either using the WebUI or the CLI.

In the Old WebUI

To configure radio settings:

1. Click the **RF** link located directly above the Search bar of the AOS-W Instant main window.
2. Click **Show advanced options**. The advanced options are displayed.
3. Click the **Radio** tab.
4. Under **2.4.GHz band** or **5 GHz band**, click **New**.
5. Configure the parameters listed in the following table:

Table 90: Radio Configuration Parameters

Parameter	Description
Name	Enter a name for the 2.4 GHz or 5 GHz radio profile.
Zone	Enter the zone name for configuration. The same zone name can be configured on a 2.4 GHz and a 5 GHz radio profile. However, the same zone name cannot be configured on two different 2.4 GHz or two different 5 GHz profiles.
Legacy only	Select Enabled to run the radio in non-802.11n mode. This option is set to Disabled by default.
802.11d / 802.11h	Select Enabled to allow the radio to advertise its 802.11d (Country Information) and 802.11h TPC capabilities. This option is set to Disabled by default.
Beacon interval	Enter the Beacon period for the OAW-IAP in milliseconds. This indicates how often the 802.11 beacon management frames are transmitted by the access point. You can specify a value within the range of 60-500. The default value is 100 milliseconds.
Interference immunity level	Select to increase the immunity level to improve performance in high-interference environments. The default immunity level is 2. <ul style="list-style-type: none"> ■ Level 0—no ANI adaptation.

Table 90: Radio Configuration Parameters

Parameter	Description
	<ul style="list-style-type: none"> ■ Level 1—Noise immunity only. This level enables power-based packet detection by controlling the amount of power increase that makes a radio aware that it has received a packet. ■ Level 2—Noise and spur immunity. This level also controls the detection of OFDM packets, and is the default setting for the Noise Immunity feature. ■ Level 3—Level 2 settings and weak OFDM immunity. This level minimizes false detects on the radio due to interference, but may also reduce radio sensitivity. This level is recommended for environments with a high-level of interference related to 2.4 GHz appliances such as cordless phones. ■ Level 4—Level 3 settings, and FIR immunity. At this level, the OAW-IAP adjusts its sensitivity to in-band power, which can improve performance in environments with high and constant levels of noise interference. ■ Level 5—The OAW-IAP completely disables PHY error reporting, improving performance by eliminating the time the OAW-IAP would spend on PHY processing. <p>NOTE: Increasing the immunity level makes the OAW-IAP to lose a small amount of range.</p>
Background spectrum monitoring	Select Enabled to allow the OAW-IAPs in access mode to continue with normal access service to clients, while performing additional function of monitoring RF interference (from both neighboring OAW-IAPs and non Wi-Fi sources such as, microwaves and cordless phones) on the channel they are currently serving clients.
Customize ARM power range	Select the check box and select a minimum (Min power) and maximum (Max power) power range value for the 2.4 GHz and 5 GHz band frequencies. The default value is 3 dBm. Unlike the configuration in the ARM profile, the transmit power of all radios in the Radio profile do not share the same configuration.
Very high throughput	Ensure that this check box is selected to enable VHT on 802.11 ac devices with 5 GHz radio. If VHT is enabled for the 5 GHz radio profile on an OAW-IAP, it is automatically enabled for all SSIDs configured on an OAW-IAP. By default, VHT is enabled on all SSIDs. If you want the 802.11 ac OAW-IAPs to function as 802.11 n OAW-IAPs, clear the check box to disable VHT on these devices.
Smart antenna	This value is Disabled by default. Select Enabled to allow smart antenna polarization on the OAW-IAP335 access points support the smart antenna feature. This feature helps optimize the selection of antenna polarization values based on data collected from the training of polarization pattern combinations. This feature identifies the clients most likely to benefit from smart antenna polarization, based on the average RSSI of the received frames and the number of streams. This feature uses frame-based antenna training, which allows the OAW-IAP to cycle through training combinations and collect statistics without causing any impact on the client. At the end of the training sequence, the OAW-IAP selects the best antenna polarization based on these collected statistics. The smart antenna feature does not support optimized antenna polarization for clients using Single-User or Multi-User transmit beamforming, and will use default polarization values for these clients.
ARM/WIDS Override	By default, WIDS protection is on dynamic mode. If an OAW-IAP is heavily loaded with client traffic and the CPU utilization exceeds the threshold limit, the WIDS processing is suspended. This causes more CPU cycles to handle the client traffic. When the CPU utilization is within the the threshold limit, the WIDS processing is resumed. When ARM/WIDS Override is off, the OAW-IAP will always process frames for WIDS purposes even when it is heavily loaded with client traffic. When ARM/WIDS Override on, the OAW-IAP will stop process frames for WIDS purposes regardless of whether the OAW-IAP is heavily loaded or not. The WIDS functionality will not take effect.

6. Click **OK** in the **New radio profile** window.

7. Click **OK** in the RF window.

In the New WebUI

To configure radio settings:

1. Navigate to **Configuration > RF** page.
2. Click **Show advanced options** at the bottom of the page.
3. Expand **Radio**.
4. Under **2.4.GHz band** or **5 GHz band**, click **+**.
5. Configure the parameters listed in the following table:

Table 91: Radio Configuration Parameters

Parameter	Description
Name	Enter a name for the 2.4 GHz or 5 GHz radio profile.
Zone	Enter the zone name for configuration. The same zone name can be configured on a 2.4 GHz and a 5 GHz radio profile. However, the same zone name cannot be configured on two different 2.4 GHz or two different 5 GHz profiles.
Legacy only	Click the toggle switch to run the radio in non-802.11n mode. This option is disabled by default.
802.11d / 802.11h	Click the toggle switch to allow the radio to advertise its 802.11d (Country Information) and 802.11h TPC capabilities. This option is disabled by default.
Beacon interval	Enter the Beacon period for the OAW-IAP in milliseconds. This indicates how often the 802.11 beacon management frames are transmitted by the access point. You can specify a value within the range of 60-500. The default value is 100 milliseconds.
Interference immunity level	<p>Select to increase the immunity level to improve performance in high-interference environments.</p> <p>The default immunity level is 2.</p> <ul style="list-style-type: none"> ■ Level 1—Noise immunity only. This level enables power-based packet detection by controlling the amount of power increase that makes a radio aware that it has received a packet. ■ Level 2—Noise and spur immunity. This level also controls the detection of OFDM packets, and is the default setting for the Noise Immunity feature. ■ Level 3—Level 2 settings and weak OFDM immunity. This level minimizes false detects on the radio due to interference, but may also reduce radio sensitivity. This level is recommended for environments with a high-level of interference related to 2.4 GHz appliances such as cordless phones. ■ Level 4—Level 3 settings, and FIR immunity. At this level, the OAW-IAP adjusts its sensitivity to in-band power, which can improve performance in environments with high and constant levels of noise interference. ■ Level 5—The OAW-IAP completely disables PHY error reporting, improving performance by eliminating the time the OAW-IAP would spend on PHY processing. <p>NOTE: Increasing the immunity level makes the OAW-IAP to lose a small amount of range.</p>
Channel switch announcement count	Specify the count to indicate the number of channel switching announcements that must be sent before switching to a new channel. This allows associated clients to recover gracefully from a channel change.
Background spectrum monitoring	Click the toggle switch to allow the OAW-IAPs in access mode to continue with normal access service to clients, while performing additional function of monitoring RF interference (from both neighboring OAW-IAPs and non Wi-Fi sources such as, microwaves and cordless phones) on the channel they are currently serving clients.

Table 91: Radio Configuration Parameters

Parameter	Description
Customize ARM power range	Click the toggle switch and select a minimum (Min power) and maximum (Max power) power range value for the 2.4 GHz and 5 GHz band frequencies. The default value is 3 dBm. Unlike the configuration in the ARM profile, the transmit power of all radios in the Radio profile do not share the same configuration.
Very high throughput	Ensure that this check box is selected to enable VHT on 802.11ac devices with 5 GHz radio. If VHT is enabled for the 5 GHz radio profile on anOAW-IAP, it is automatically enabled for all SSIDs configured on anOAW-IAP. By default, VHT is enabled on all SSIDs. If you want the 802.11ac OAW-IAPs to function as 802.11n OAW-IAPs, clear the check box to disable VHT on these devices.
Smart antenna	This value is Disabled by default. Select Enabled to allow smart antenna polarization on the OAW-IAP335 access points support the smart antenna feature. This feature helps optimize the selection of antenna polarization values based on data collected from the training of polarization pattern combinations. This feature identifies the clients most likely to benefit from smart antenna polarization, based on the average RSSI of the received frames and the number of streams. This feature uses frame-based antenna training, which allows the OAW-IAP to cycle through training combinations and collect statistics without causing any impact on the client. At the end of the training sequence, the OAW-IAP selects the best antenna polarization based on these collected statistics. The smart antenna feature does not support optimized antenna polarization for clients using Single-User or Multi-User transmit beamforming, and will use default polarization values for these clients.

5. Click **OK**.

6. Click **Save**.

In the CLI

To configure 2.4 GHz radio settings:

```
(Instant AP) (config)# rf dot11g-radio-profile
(Instant AP) (RF dot11g Radio Profile)# beacon-interval <milliseconds>
(Instant AP) (RF dot11g Radio Profile)# legacy-mode
(Instant AP) (RF dot11g Radio Profile)# spectrum-monitor
(Instant AP) (RF dot11g Radio Profile)# dot11h
(Instant AP) (RF dot11g Radio Profile)# interference-immunity <level>
(Instant AP) (RF dot11g Radio Profile)# csa-count <count>
(Instant AP) (RF dot11g Radio Profile)# max-distance <count>
(Instant AP) (RF dot11g Radio Profile)# max-tx-power <db>
(Instant AP) (RF dot11g Radio Profile)# min-tx-power <db>
(Instant AP) (RF dot11g Radio Profile)# smart-antenna
```

To configure 5 GHz radio settings:

```
(Instant AP) (config)# rf dot11a-radio-profile
(Instant AP) (RF dot11a Radio Profile)# beacon-interval <milliseconds>
(Instant AP) (RF dot11a Radio Profile)# legacy-mode
(Instant AP) (RF dot11a Radio Profile)# spectrum-monitor
(Instant AP) (RF dot11a Radio Profile)# spectrum-band <type>
(Instant AP) (RF dot11a Radio Profile)# dot11h
(Instant AP) (RF dot11a Radio Profile)# interference-immunity <level>
(Instant AP) (RF dot11a Radio Profile)# max-distance <count>
(Instant AP) (RF dot11a Radio Profile)# max-tx-power <db>
(Instant AP) (RF dot11a Radio Profile)# min-tx-power <db>
(Instant AP) (RF dot11a Radio Profile)# smart-antenna
(Instant AP) (RF dot11a Radio Profile)# csa-count <count>
```

To disable VHT on a 5 GHz radio profile:

```
(Instant AP) (config)# rf dot11a-radio-profile
```

```
(Instant AP) (RF dot11a Radio Profile) # very-high-throughput-disable
```

To view the radio configuration:

```
(Instant AP) # show radio config
```

```
2.4 GHz:
Legacy Mode:enable
Beacon Interval:100
802.11d/802.11h:enable
Interference Immunity Level:2
Channel Switch Announcement Count:0
MAX Distance:600
Channel Reuse Type:disable
Channel Reuse Threshold:0
Background Spectrum Monitor:disable
```

```
5.0 GHz:
Legacy Mode:enable
Beacon Interval:100
802.11d/802.11h:enable
Interference Immunity Level:2
Channel Switch Announcement Count:2
MAX Distance:600
Channel Reuse Type:disable
Channel Reuse Threshold:0
Background Spectrum Monitor:disable
Standalone Spectrum Band:5ghz-upper
```

Configuring Cell Size Reduction using the CLI

The Cell Size Reduction feature allows you to manage dense deployments and to increase overall system performance and capacity by shrinking an OAW-IAPs receive coverage area, thereby minimizing co-channel interference and optimizing channel reuse.

The default 0 dB reduction allows the radio to retain its current default Rx sensitivity value.

Values from 1 dB–55 dB reduce the power level that the radio can hear by that amount. If you configure this feature to use a non-default value, you must also reduce the radio's transmission power to match its new received (Rx) power level. Failure to match a device's Tx power level to its Rx power level can result in a configuration that allows the radio to send messages to a device that it cannot hear.

To configure Cell Size Reduction for 2.4 GHz radio profile in the CLI:

```
(Instant AP) (config) # rf dot11g-radio-profile
(Instant AP) (RF dot11g Radio Profile) # cell-size-reduction <reduction>
```

To configure Cell Size Reduction for 5 GHz radio profile in the CLI:

```
(Instant AP) (config) # rf dot11a-radio-profile
(Instant AP) (RF dot11a Radio Profile) # cell-size-reduction <reduction>
```

ARM Channel Selection using the CLI

Starting from AOS-W Instant 6.5.0.0-4.3.0.0, OAW-IAPs can search for a new environment in a short span of time, so that the ARM is triggered to perform frequent scanning and selection of a valid channel for transmission.

By default, the ARM is triggered to scan all the channels every 10 seconds, and select the best channel for transmission. But when the OAW-IAP is in a new environment, ARM is triggered to perform frequent scanning of the non-DFS channels every 200 milliseconds, and select the best available channel for transmission. The **ap-frequent-scan** command is introduced in the CLI to enable the OAW-IAPs to trigger frequent scanning of transmission signals on a radio profile.



Wireless connection is affected for a few seconds when the frequent scanning of non-DFS channels is ongoing. The connection is re-established after the ARM selects a valid channel. Typically, a frequent scanning session lasts for less than 10 seconds.

Perform the following checks before scanning:

- The DFS channels must be skipped (this is done to avoid delays in scanning).
- The OAW-IAP must be on stand-alone mode.
- The **client-aware** parameter must be disabled in the ARM profile.

In the CLI

The following example triggers ARM scanning on a 2.4 GHz frequency band radio profile:

```
(Instant AP)# ap-frequent-scan 2.4
```

To verify the status of ARM scanning:

```
(Instant AP)# show ap debug am-config
```

Support for channels 169 and 173 on Outdoor OAW-IAP

Starting from Alcatel-Lucent AOS-W Instant 8.4.0.0, 5 GHz band on an outdoor OAW-IAP includes the 169 and 173 channels. These channels are currently supported only in India.

This chapter provides the following information:

- [DPI on page 360](#)
- [Enabling Application Visibility on page 360](#)
- [Application Visibility on page 361](#)
- [Enabling URL Visibility on page 361](#)
- [Configuring ACL Rules for Application and Application Categories on page 362](#)
- [Configuring Web Policy Enforcement Service on page 367](#)

DPI

AppRF is Alcatel-Lucent's custom-built Layer 7 firewall capability. It consists of an onboard DPI and a cloud-based Web Policy Enforcement service that allows creating firewall policies based on types of application. The WPE capabilities require the OAW-IAP to have a WPE subscription. For more information on subscription, contact the Alcatel-Lucent Sales Team.

OAW-IAPs with DPI capability analyze data packets to identify applications in use and allow you to create access rules to determine client access to applications, application categories, web categories, and website URLs based on web reputation. You can also define traffic-shaping policies such as bandwidth control and QoS per application for client roles. For example, you can block bandwidth-monopolizing applications on a guest role within an enterprise.

The AppRF feature provides application visibility for analyzing client traffic flow. OAW-IAPs support the power of both in-device packet flow identification and dynamically updated cloud-based web categorization.

Enabling Application Visibility

Enabling AppRF visibility allows you to view the AppRF statistics for an OAW-IAP or the clients associated with an OAW-IAP. Full URL visibility for HTTP sessions fed to ALE is exposed as northbound APIs which can be consumed by URL analytical engines for advanced client URL data mining and analytics.

You can enable AppRF visibility by using the WebUI or the CLI.

In the Old WebUI

To enable AppRF:

1. Navigate to **System > General**.
2. Select **All** from the **AppRF visibility** drop-down list to view both application and web categories charts or select either **App** or **WebCC** to view their DPI graphs separately.
3. Click **OK**.

In the New WebUI

To enable AppRF:

1. Navigate to the **Configuration > System > General** section.
2. Select **All** from the **AppRF visibility** drop-down list to view both application and web categories charts or select either **App** or **WebCC** to view their DPI graphs separately.

3. Click **Save**.

In the CLI

To enable AppRF visibility:

```
(Instant AP) (config)# dpi [app|webcc]
```

Application Visibility

The AppRF graphs are based on DPI application and Web Policy Enforcement service, which provide application traffic summary for the client devices associated with an OAW-IAP. The **AppRF** link above the activity panel of the dashboard is displayed only if **AppRF visibility** is enabled in the old or new WebUI.

The AppRF dashboard presents four different graph areas with data graphs on all client traffic and content filters based on App Category, Web Category, and Web Reputation. Click each category to view the real-time client traffic data or usage trend in the last 15 minutes or 1 minute.

The **permit** and **deny** monitoring tabs in the All Traffic and Web Content sections provide enforcement visibility support.

- **Permit** represents the allowed or permitted traffic on the OAW-IAP.
- **Deny** represents all the blocked URLs and traffic .

Application Categories Chart

The application categories chart displays details on the client traffic towards the application categories. By clicking the rectangle area, you can view the graphs and toggle between the chart and list views.

Applications Chart

The applications chart displays details on the client traffic towards the applications. By clicking the rectangular area, you can view the graphs and toggle between the chart and list views.

Web Categories Charts

The web categories chart displays details about the client traffic to the web categories. By clicking the rectangle area, you can view the graphs and toggle between the chart and list views.

Web Reputation Charts

The web reputation chart displays details about the client traffic to the URLs that are assigned security ratings. By clicking in the rectangle area, you can view the graphs and toggle between the chart and list views.

Enabling URL Visibility

Enabling URL visibility allows the OAW-IAP to extract the full URL information of the HTTP and HTTPS sessions and periodically log them on the ALE server. Full URL visibility for HTTP sessions fed to ALE are exposed as Northbound APIs, and are used by URL analytical engines for advanced client URL data mining and analysis.

You can enable URL visibility by using the WebUI or the CLI:

In the Old WebUI

To enable URL visibility:

1. Navigate to **System > General**.
2. Select **Enabled** from the **URL visibility** drop-down list.

3. Click **OK**.

In the New WebUI

To enable URL visibility:

1. Navigate to **Configuration > System > General** page.
2. Toggle the **URL visibility** switch to enable.
3. Click **Save**.

In the CLI

To enable URL visibility:

```
(Instant AP) (config)# url-visibility
```

Configuring ACL Rules for Application and Application Categories

This section describes the procedure for configuring access rules based on application and application categories. The Application and Application rules utilize the onboard DPI engine.

- For information on configuring access rules to control access to network services, see [Configuring ACL Rules for Network Services on page 240](#).
- For information on configuring access rules based on web categories and web reputation, see [Configuring Web Policy Enforcement Service on page 367](#).

In the Old WebUI

To configure ACL rules for a user role:

1. Navigate to the **Security > Roles** tab. The **Roles** tab contents are displayed.

You can also configure access rules for a wired or wireless network profile by using:

- a. The WLAN wizard (**Network > WLAN SSID > Edit > Edit WLAN > Access**) or
 - b. The Wired profile (**More > Wired > Edit > Edit Wired Network > Access**) window.
2. In the **Roles** section, select the role for which you want to configure the access rules.
 3. In the **Access rules** section, click **New** to add a new rule. The **New Rule** window is displayed.
 4. Ensure that the rule type is set to **Access control**.
 5. To configure access to applications or application category, select a service category from the following list:
 - Application
 - Application category
 6. Based on the selected service category, configure the following parameters:

Table 92: Access Rule Configuration Parameters

Service Category	Description
Application	Select the applications to which you want to allow or deny access.
Application category	<p>Select any of the following application categories to which you want to allow or deny access:</p> <ul style="list-style-type: none"> ■ antivirus ■ authentication ■ cloud-file-storage ■ collaboration ■ encrypted ■ enterprise-apps ■ gaming ■ im-file-transfer ■ instant-messaging ■ mail-protocols ■ mobile-app-store ■ network-service ■ peer-to-peer ■ social-networking ■ standard ■ streaming ■ thin-client ■ tunneling ■ unified-communications ■ web ■ Webmail
Application Throttling	<p>Application throttling allows you to set a bandwidth limit for an application, application category, web category, or for sites based on their web reputation. For example, you can limit the bandwidth rate for video streaming applications such as YouTube or Netflix, or assign a low bandwidth to high-risk sites. If your OAW-IAP model does not support configuring access rules based on application or application category, you can create a rule based on web category or website reputation and assign bandwidth rates. This checkbox is visible only when the service selected is Application.</p> <p>To specify a bandwidth limit:</p> <ol style="list-style-type: none"> 1. Select the Application Throttling check box. 2. Specify the downstream and upstream rates in Kbps.
Action	<p>Select any of following actions:</p> <ul style="list-style-type: none"> ■ Select Allow to allow access to users based on the access rule. ■ Select Deny to deny access to users based on the access rule. ■ Select Destination-NAT to allow changes to destination IP address. ■ Select Source-NAT to allow changes to the source IP address. <p>The destination NAT and source NAT actions apply only to the network services rules.</p>
Destination	<p>Select a destination option for the access rules for network services, applications, and application categories. You can allow or deny access to any the following destinations based on your requirements.</p> <ul style="list-style-type: none"> ■ to all destinations—Access is allowed or denied to all destinations. ■ to a particular server—Access is allowed or denied to a particular server. After selecting this option, specify the IP address of the destination server. ■ except to a particular server—Access is allowed or denied to servers other than the specified server. After selecting this option, specify the IP address of the destination server. ■ to a network—Access is allowed or denied to a network. After selecting this option, specify the IP address and netmask for the destination network.

Table 92: Access Rule Configuration Parameters

Service Category	Description
	<ul style="list-style-type: none"> ■ except to a network—Access is allowed or denied to networks other than the specified network. After selecting this option, specify the IP address and netmask of the destination network. ■ to domain name—Access is allowed or denied to the specified domains. After selecting this option, specify the domain name in the Domain Name text box. ■ to master IP—Access is allowed or denied to the master IP address. ■ to AP IP—Access is allowed or denied to a specific AP's IP address. ■ to AP network—Access is allowed or denied to a specific AP network.
Log	Select this check box to create a log entry when this rule is triggered. AOS-W Instant supports firewall-based logging function. Firewall logs on the OAW-IAPs are generated as security logs.
Blacklist	Select the Blacklist check box to blacklist the client when this rule is triggered. The blacklisting lasts for the duration specified in Auth failure blacklist time on the Blacklisting tab of the Security window. For more information, see Blacklisting Clients on page 232 .
Disable scanning	Select Disable scanning check box to disable ARM scanning when this rule is triggered. The selection of the Disable scanning applies only if ARM scanning is enabled. For more information, see Configuring Radio Settings on page 354 .
DSCP tag	Select the DSCP tag check box to specify a DSCP value to prioritize traffic when this rule is triggered. Specify a value within the range of 0–63. To assign a higher priority, specify a higher value.
802.1p priority	Select the 802.1p priority check box to specify an 802.1p priority. Specify a value between 0 and 7. To assign a higher priority, specify a higher value.
802.1p priority	Select the Time Range check box and select a time profile to apply for the rule.

3. Click **OK** in the **New Rule** window.
4. Click **OK** in the **Roles** tab.

In the New WebUI

To configure ACL rules for a user role:

1. Navigate to **Configuration > Security > Roles** section.

You can also configure access rules for a wired or wireless network profile by following the steps mentioned below:

- a. Navigate to **Configuration > Networks**.
 - b. Select the WLAN or the Wired profile and edit the profile as required.
 - c. Go to the **Access** tab.
2. In the **Roles** section, select the role for which you want to configure the access rules.
 3. In the **Access Rules for <network>** section, click **+** to add a new rule. The **New rule** window is displayed.
 4. Ensure that the rule type is set to **Access control**.
 5. To configure access to applications or application category, select a service from the following list:
 - Application
 - Application category

6. Based on the selected service category, configure the following parameters:

Table 93: Access Rule Configuration Parameters

Service Category	Description
Application	Select the applications to which you want to allow or deny access.
Application category	<p>Select any of the following application categories to which you want to allow or deny access:</p> <ul style="list-style-type: none"> ■ antivirus ■ authentication ■ cloud-file-storage ■ collaboration ■ encrypted ■ enterprise-apps ■ gaming ■ im-file-transfer ■ instant-messaging ■ mail-protocols ■ mobile-app-store ■ network-service ■ peer-to-peer ■ social-networking ■ standard ■ streaming ■ thin-client ■ tunneling ■ unified-communications ■ web ■ Webmail
Application Throttling	<p>Application throttling allows you to set a bandwidth limit for an application, application category, web category, or for sites based on their web reputation. For example, you can limit the bandwidth rate for video streaming applications such as YouTube or Netflix, or assign a low bandwidth to high-risk sites. If your OAW-IAP model does not support configuring access rules based on application or application category, you can create a rule based on web category or website reputation and assign bandwidth rates. This check-box is visible only when the Application service is selected..</p> <p>To specify a bandwidth limit:</p> <ol style="list-style-type: none"> 1. Select the Application Throttling check box. 2. Specify the downstream and upstream rates in Kbps.
Action	<p>Select any of following actions:</p> <ul style="list-style-type: none"> ■ Select Allow to allow access to users based on the access rule. ■ Select Deny to deny access to users based on the access rule. ■ Select Destination-NAT to allow changes to destination IP address. ■ Select Source-NAT to allow changes to the source IP address. <p>The destination NAT and source NAT actions apply only to the network services rules.</p>
Destination	<p>Select a destination option for the access rules for network services, applications, and application categories. You can allow or deny access to any the following destinations based on your requirements.</p> <ul style="list-style-type: none"> ■ to all destinations—Access is allowed or denied to all destinations. ■ to a particular server—Access is allowed or denied to a particular server. After selecting this option, specify the IP address of the destination server. ■ except to a particular server—Access is allowed or denied to servers other than the specified server. After selecting this option, specify the IP address of the destination server.

Table 93: Access Rule Configuration Parameters

Service Category	Description
	<ul style="list-style-type: none"> ■ to a network—Access is allowed or denied to a network. After selecting this option, specify the IP address and netmask for the destination network. ■ except to a network—Access is allowed or denied to networks other than the specified network. After selecting this option, specify the IP address and netmask of the destination network. ■ to domain name—Access is allowed or denied to the specified domains. After selecting this option, specify the domain name in the Domain Name text box. ■ to master IP—Access is allowed or denied to the master IP address. ■ to AP IP—Access is allowed or denied to a specific AP's IP address. ■ to AP network—Access is allowed or denied to a specific AP network.
Log	Select this check box to create a log entry when this rule is triggered. AOS-W Instant supports firewall-based logging function. Firewall logs on the OAW-IAPs are generated as security logs.
Blacklist	Select the Blacklist check box to blacklist the client when this rule is triggered. The blacklisting lasts for the duration specified in Auth failure blacklist time on the Blacklisting tab of the Security window. For more information, see Blacklisting Clients on page 232 .
Disable scanning	Select Disable scanning check box to disable ARM scanning when this rule is triggered. The selection of the Disable scanning applies only if ARM scanning is enabled. For more information, see Configuring Radio Settings on page 354 .
DSCP Tag	Select the DSCP Tag check box to specify a DSCP value to prioritize traffic when this rule is triggered. Specify a value within the range of 0–63. To assign a higher priority, specify a higher value.
802.1p priority	Select the 802.1p priority check box to specify an 802.1p priority. Specify a value between 0 and 7. To assign a higher priority, specify a higher value.
Time Range	Select the Time Range check box and select a time profile to apply for the rule.

3. Click **OK**.
4. Click **Save**.

In the CLI

To configure access rules:

```
(Instant AP) (config)# wlan access-rule <access-rule-name>
(Instant AP) (Access Rule <Name>)#rule <dest> <mask> <match/invert> {app <app>
{permit|deny}|appcategory <appgrp>} [<option1...option9>]
```

Examples

The following CLI example shows how to configure employee access rules:

```
(Instant AP) (config)# wlan access-rule employee
(Instant AP) (Access Rule "employee")# rule any any match app youtube permit throttle-
downstream 256 throttle-up 256
(Instant AP) (Access Rule "employee")# rule any any match appcategory collaboration permit
(Instant AP) (Access Rule "employee")# rule any any match any any any permit time-range
lunchtime
```

The following CLI example shows how to view the list of time profiles created on the OAW-IAP:

```
(Instant AP)# show time-profile
```

The following CLI example shows how to view the list of time range profiles configured on the OAW-IAP:

```
(Instant AP)# show time-range
```

Configuring Web Policy Enforcement Service

You can configure the WPE service on an OAW-IAP to block certain categories of websites based on your organization specifications by defining ACL rules by using the WebUI or the CLI.

In the Old WebUI

To configure WPE service:

1. Navigate to **Security > Roles**.
2. Under **Roles**, select any WLAN SSID or wired profile role, and click **New** in the **Access Rules for <network>** section. The **New Rule** window is displayed.
3. Select the rule type as **Access Control**.
4. To set an access policy based on the web category:
 - a. Under **Service**, click the **Web category** radio button and expand the drop-down list that contains the web categories.
 - b. Select the categories to which you want to deny or allow access. You can also search for a web category and select the required option.
 - c. From the **Action** drop-down list, select **Allow** or **Deny** as required.
 - d. Click **OK** in the **New Rule** window.
 - e. Click **OK** in the **Roles** tab.
5. To filter access based on the security ratings of the website:
 - a. Select **Web reputation** under **Service**.
 - b. Move the slider to the required security rating level. Move the slider to select a specific web reputation value to deny access to websites with a reputation value lower than or equal to the configured value or to permit access to websites with a reputation value higher than or equal to the configured value. The following options are available:
 - **Trustworthy**—These are well known sites with strong security practices and may not expose the user to security risks. There is a very low probability that the user will be exposed to malicious links or payloads.
 - **Low risk**—These are benign sites and may not expose the user to security risks. There is a low probability that the user will be exposed to malicious links or payloads.
 - **Moderate risk**—These are generally benign sites, but may pose a security risk. There is some probability that the user will be exposed to malicious links or payloads.
 - **Suspicious**—These are suspicious sites. There is a higher than average probability that the user will be exposed to malicious links or payloads.
 - **High risk**—These are high-risk sites. There is a high probability that the user will be exposed to malicious links or payloads.
 - c. From the **Action** drop-down list, select **Allow** or **Deny** as required.



For a complete list of categories and information about each of these categories, visit the BrightCloud® Security Services web page at <http://www.brightcloud.com/tools/change-request-url-ip.php>.

6. To set a bandwidth limit based on web category or web reputation score, select the **Application Throttling** check box and specify the downstream and upstream rates in Kbps. For example, you can set a higher bandwidth for trusted sites and a low bandwidth rate for high-risk sites.
7. If required, select the following check boxes :
 - Log
 - Blacklist
 - Disable scanning
 - DSCP tag
 - Time Range
 - 802.1p priority
8. Click **OK** in the **New Rule** window.
9. Click **OK** in the **Roles** tab.

In the New WebUI

To configure WPE service:

1. Navigate to **Configuration > Security > Roles** section.
2. Under **Roles** , select any WLAN SSID or wired profile role, and click + in the **Access Rules for <network>** section. The **New rule** window is displayed.
3. Select the rule type as **Access control**.
4. To set an access policy based on the web category:
 - a. Under **Service**, select the **Web category** radio button and expand the corresponding drop-down list that contains the web categories.
 - b. Select the categories to which you want to deny or allow access. You can also search for a web category and select the required option.
 - c. From the **Action** drop-down list, select **Allow** or **Deny** as required.
 - d. Click **OK**.
 - e. Click **Save**.
5. To filter access based on the security ratings of the website:
 - a. Select **Web reputation** under **Service**.
 - b. Move the slider to the required security rating level. Move the slider to select a specific web reputation value to deny access to websites with a reputation value lower than or equal to the configured value or to permit access to websites with a reputation value higher than or equal to the configured value. The following options are available:
 - **Trustworthy**—These are well known sites with strong security practices and may not expose the user to security risks. There is a very low probability that the user will be exposed to malicious links or payloads.
 - **Low risk**—These are benign sites and may not expose the user to security risks. There is a low probability that the user will be exposed to malicious links or payloads.
 - **Moderate risk**—These are generally benign sites, but may pose a security risk. There is some probability that the user will be exposed to malicious links or payloads.
 - **Suspicious**—These are suspicious sites. There is a higher than average probability that the user will be exposed to malicious links or payloads.
 - **High risk**—These are high-risk sites. There is a high probability that the user will be exposed to malicious links or payloads.
 - c. From the **Action** drop-down list, select **Allow** or **Deny** as required.



For a complete list of categories and information about each of these categories, visit the BrightCloud® Security Services web page at <http://www.brightcloud.com/tools/change-request-url-ip.php>.

6. To set a bandwidth limit based on web category or web reputation score, select the **Application Throttling** check box and specify the downstream and upstream rates in Kbps. For example, you can set a higher bandwidth for trusted sites and a low bandwidth rate for high-risk sites.

7. If required, select the following check boxes :

- Log
- Blacklist
- DSCP tag
- Disable scanning
- 802.1p priority

8. Click **OK**.

9. Click **Save**.

In the CLI

To control access based on web categories and security ratings:

```
(Instant AP) (config)# wlan access-rule <access_rule>
(Instant AP) (Access Rule "<access-rule>")# rule <dest> <mask> <match> webcategory <webgrp>
{permit | deny}[<option1....option9>]
(Instant AP) (Access Rule "<access-rule>")# rule <dest> <mask> <match> webreputation <webrep>
{permit | deny}[<option1....option9>]
```

Example

The following CLI example shows how to set access rules based on the web category and the web reputation:

```
(Instant AP) (config)# wlan access-rule URLFilter
(Instant AP) (Access Rule "URLFilter")# rule any any match webcategory gambling deny
(Instant AP) (Access Rule "URLFilter")# rule any any match webcategory training-and-tools
permit
(Instant AP) (Access Rule "URLFilter")# rule any any match webreputation suspicious-sites deny
```

This chapter explains the steps required to configure voice and video services on an OAW-IAP for VoIP devices, SIP, SVP, H323, SCCP, Vocera, and Alcatel NOE phones, clients running Microsoft OCS, and Apple devices running the Facetime application.

This section includes the following topics:

- [WMM Traffic Management on page 370](#)
- [Media Classification for Voice and Video Calls on page 373](#)
- [Enabling Enhanced Voice Call Tracking on page 375](#)
- [Wi-Fi Calling on page 375](#)

WMM Traffic Management

WMM is a WFA specification based on the IEEE 802.11e wireless QoS standard. WMM works with 802.11a, 802.11b, 802.11g, and 802.11n physical layer standards.

WMM supports the following ACs:

- Voice
- Video
- Best effort
- Background

The following table shows the mapping of the WMM access categories to 802.1p priority values. The 802.1p priority value is contained in a two-byte QoS control field in the WMM data frame.

Table 94: WMM AC to 802.1p Priority Mapping

802.1p Priority	WMM Access Category
1	Background
2	
0	Best effort
3	
4	Video
5	
6	Voice
7	

In a non-WMM or hybrid environment, where some clients are not WMM-capable, you can configure an SSID with higher values for best effort and voice ACs, to allocate a higher bandwidth to clients transmitting best effort and voice traffic.

Configuring WMM for Wireless Clients

You can configure WMM for wireless clients by using the WebUI or the CLI.

In the Old WebUI

To configure the WMM for wireless clients:

1. Navigate to the WLAN wizard.
 - a. Navigate to **Networks > New** or
 - b. Navigate to **Networks**, select the WLAN profile and click **edit**.
2. Click **Show advanced options** under **WLAN Settings**.
3. In the **WMM** section, specify a percentage value for the following access categories in the corresponding **Share** text box. You can allocate a higher bandwidth for voice and video traffic than that for other types of traffic based on the network profile.
 - **Background WMM**—Allocates bandwidth for background traffic such as file downloads or print jobs.
 - **Best effort WMM**—Allocates bandwidth or best effort traffic such as traffic from legacy devices or traffic from applications or devices that do not support QoS.
 - **Video WMM**—Allocates bandwidth for video traffic generated from video streaming.
 - **Voice WMM**—Allocates bandwidth for voice traffic generated from the incoming and outgoing voice communication.
4. Click **Next** and complete the configurations as required.
5. Click **Finish**.

In the New WebUI

To configure the WMM for wireless clients:

1. Navigate to the WLAN wizard.
 - a. Navigate to **Configuration > Networks** and click **+** or
 - b. Navigate to **Configuration > Networks**, select the WLAN profile, and edit the profile as required.
2. Under **Basic**, click **Show advanced options**.
3. Under **WMM**, specify a **Share** percentage value for the following access categories, in the text box that appears before **%**. You can allocate a higher bandwidth for voice and video traffic than that for other types of traffic based on the network profile.
 - **Background WMM**—Allocates bandwidth for background traffic such as file downloads or print jobs.
 - **Best effort WMM**—Allocates bandwidth or best effort traffic such as traffic from legacy devices or traffic from applications or devices that do not support QoS.
 - **Video WMM**—Allocates bandwidth for video traffic generated from video streaming.
 - **Voice WMM**—Allocates bandwidth for voice traffic generated from the incoming and outgoing voice communication.
4. Click **Next** until **Finish**.

In the CLI

Configuring WMM for wireless clients:

```
(Instant AP) (config)# wlan ssid-profile <name>
(Instant AP) (SSID Profile <name>)# wmm-background-share <share>
(Instant AP) (SSID Profile <name>)# wmm-best-effort-share <share>
(Instant AP) (SSID Profile <name>)# wmm-video-share <share>
(Instant AP) (SSID Profile <name>)# wmm-voice-share <share>
```

Mapping WMM ACs and DSCP Tags

The IEEE 802.11e standard defines the mapping between WMM ACs and DSCP tags. You can customize the mapping values between WMM ACs and DSCP tags to prioritize various traffic types and apply these changes to a WMM-enabled SSID profile.

DSCP classifies packets based on network policies and rules. The following table shows the default WMM AC to DSCP mappings and the recommended WMM AC to DSCP mappings.

Table 95: WMM AC-DSCP Mapping

DSCP Value	WMM Access Category
8	Background
16	
0	Best effort
24	
32	Video
40	
48	Voice
56	

By customizing WMM AC mappings, all packets received are matched against the entries in the mapping table and prioritized accordingly. The mapping table contains information for upstream (client to OAW-IAP) and downstream (OAW-IAP to client) traffic.

You can configure different WMM to DSCP mapping values for each WMM AC when configuring an SSID profile by using the WebUI or the CLI.

In the Old WebUI

To configure DSCP mapping values:

1. Navigate to the WLAN wizard.
 - a. Navigate to **Networks > New** or
 - b. Navigate to **Networks**, select the WLAN profile and click **edit**.
2. Click **Show advanced options** under **WLAN Settings**.
3. Click **Show advanced options**.
4. In the **WMM** section, specify the appropriate DSCP mapping values within a range of 0–63 for the following access categories in the corresponding **DSCP mapping** text box:
 - **Background WMM**—DSCP mapping for the background traffic.
 - **Best effort WMM**—DSCP mapping for the best-effort traffic.
 - **Video WMM**—DSCP mapping for the video traffic.
 - **Voice WMM**—DSCP mapping for the voice traffic.
5. Click **Next** and complete the configurations as required.
6. Click **Finish**.

In the New WebUI

To configure DSCP mapping values:

1. Navigate to the WLAN wizard.
 - a. Go to **Configuration** > **Networks** and click **+** or
 - b. Go to **Configuration** > **Networks**, select the WLAN profile, and edit the profile as required.
2. Under **Basic**, click **Show advanced options**.
3. Under **WMM**, specify the appropriate DSCP mapping values within a range of 0–63 for the following access categories in the text box that appears after **%**.
 - **Background WMM**—DSCP mapping for the background traffic.
 - **Best effort WMM**—DSCP mapping for the best-effort traffic.
 - **Video WMM**—DSCP mapping for the video traffic.
 - **Voice WMM**—DSCP mapping for the voice traffic.
4. Click **Next** until **Finish**.

In the CLI

Configuring DSCP settings on an SSID:

```
(Instant AP) (config)# wlan ssid-profile <name>
(Instant AP) (SSID Profile <name>)# wmm-background-dscp <dscp>
(Instant AP) (SSID Profile <name>)# wmm-best-effort-dscp <dscp>
(Instant AP) (SSID Profile <name>)# wmm-video-dscp <dscp>
(Instant AP) (SSID Profile <name>)# wmm-voice-dscp <dscp>
```

You can configure up to 8 DSCP mappings values within the range of 0-63. You can also configure a combination of multiple values separated by a comma, for example, **wmm-voice-dscp 46,44,42,41**.

Configuring WMM U-APSD

To extend the battery life and enable power saving on WLAN clients, OAW-IAPs support U-APSD for the clients that support WMM. The U-APSD or the WMM Power Save feature is enabled by default on all SSIDs. When configured, U-APSD enables a client station to retrieve the unicast QoS traffic buffered in the OAW-IAP by sending trigger frames. During the association or reassociation with the OAW-IAP, the station indicates the WMM Access Categories for which U-APSD is enabled. In the current release, OAW-IAPs support U-APSD on all WMM ACs.

To disable U-APSD on an SSID:

```
(Instant AP) (config)# wlan ssid-profile <ssid_profile>
(Instant AP) (SSID Profile "<ssid_profile>")# wmm-uapsd-disable
```

To re-enable U-APSD on an SSID:

```
(Instant AP) (config)# wlan ssid-profile <ssid_profile>
(Instant AP) (SSID Profile "<ssid_profile>")# no wmm-uapsd-disable
```

Media Classification for Voice and Video Calls

Media classification and data prioritization for voice and video calls in AOS-W Instant is handled automatically by the OAW-IAP's firewall for traffic that is allowed by wired ports and user ACLs. The firewall inspects each UDP packet, classifies it as either Voice or Video and correspondingly sets a DSCP value for the packet.

Traffic that is allowed in the network is configured using ACL rules. The OAW-IAP's firewall automatically allows voice and video call sessions from Skype for Business and Apple Facetime. For all other Skype for Business and Facetime applications such as desktop sharing and file transfer the corresponding ports must be opened using ACL rules.

Before media transmission, a VOIP client may initiate a Session Traversal Utilities for NAT (STUN) connectivity check and establishes a session. STUN sessions are subjected to media classification and are marked as RTP or non-RTP traffic. The RTP traffic is classified as either voice or video and re-marked with the corresponding DSCP values configured in the SSID profile, while the non-RTP traffic is forwarded without re-marking. If data packets are found to be non-compliant with the RTP parameters required in the datapath for classification, the session is marked as best effort and no flags or DSCP is set.



The default DSCP values for calls prioritized by media classification is 48 for a voice session and 40 for a video session.

If AppRF is enabled on the SSID, **alg-rtsp** must be explicitly permitted in the ACL to allow voice and video traffic in the network. The following is the ACL entry to allow RTP traffic and configuring this is highly recommended:

```
(Instant AP) (VOIP-acl)# rule any any match app alg-rtsp permit
```



If AppRF is enabled and alg-rtsp is not allowed, no voice or video traffic will flow through the network.

When AppRF is enabled, applications must be permitted explicitly in the ACL using their app IDs for the OAW-IAP to allow that particular traffic to flow in the network. Allowing application traffic is necessary for establishing control sessions only after which a voice or video session is established. To obtain full inspection and control of voice and video traffic you can populate an ACL permitting particular apps. The following is a recommended ACL configuration for an SSID profile:

```
(Instant AP) (config)# wlan access-rule VOIP-acl
(Instant AP) (VOIP-acl)# rule any any match app alg-facetime permit
(Instant AP) (VOIP-acl)# rule any any match app alg-facetime-audio permit
(Instant AP) (VOIP-acl)# rule any any match app alg-ftp permit
(Instant AP) (VOIP-acl)# rule any any match app alg-h323 permit
(Instant AP) (VOIP-acl)# rule any any match app alg-jabber-audio permit
(Instant AP) (VOIP-acl)# rule any any match app alg-jabber-desktop-sharing permit
(Instant AP) (VOIP-acl)# rule any any match app alg-jabber-mc permit
(Instant AP) (VOIP-acl)# rule any any match app alg-jabber-video permit
(Instant AP) (VOIP-acl)# rule any any match app alg-noe permit
(Instant AP) (VOIP-acl)# rule any any match app alg-rtsp permit
(Instant AP) (VOIP-acl)# rule any any match app alg-rtsp permit
(Instant AP) (VOIP-acl)# rule any any match app alg-sccp permit
(Instant AP) (VOIP-acl)# rule any any match app alg-sip permit
(Instant AP) (VOIP-acl)# rule any any match app alg-sip-audio permit
(Instant AP) (VOIP-acl)# rule any any match app alg-sip-video permit
(Instant AP) (VOIP-acl)# rule any any match app alg-skype4b-app-sharing permit
(Instant AP) (VOIP-acl)# rule any any match app alg-skype4b-audio permit
(Instant AP) (VOIP-acl)# rule any any match app alg-skype4b-desktop-sharing permit
(Instant AP) (VOIP-acl)# rule any any match app alg-skype4b-file-transfer permit
(Instant AP) (VOIP-acl)# rule any any match app alg-skype4b-secure permit
(Instant AP) (VOIP-acl)# rule any any match app alg-skype4b-video permit
(Instant AP) (VOIP-acl)# rule any any match app alg-svp permit
(Instant AP) (VOIP-acl)# rule any any match app alg-vocera permit
(Instant AP) (VOIP-acl)# rule any any match app alg-wifi-calling permit
(Instant AP) (VOIP-acl)# end
(Instant AP)# commit apply
```

Alternatively, users can define an higher precedence **allow-all** rule in the ACL which will allow all application, video and voice traffic in the network without having to permit them explicitly. The following is the ACL configuration to allow all traffic:

```
(Instant AP) (config)# wlan access-rule allow-all
(Instant AP) (allow-all)# rule any any match any any any permit
```

Enabling Enhanced Voice Call Tracking

Alcatel-Lucent AOS-W Instant provides seamless support for tracking VoIP calls in the network by using SNMP to send the location details of the caller to the third-party server. This feature is currently applied for tracking Emergency 911 VoIP calls.

The Master OAW-IAP identifies the location from where the VoIP call was placed and sends the details of the location to the third-party SNMP server. You must configure the third-party server as an SNMP host and enable SNMP traps to activate the voice call tracking feature on the OAW-IAP. For more information on configuring a third-party server as an SNMP host, see [Configuring SNMP on page 474](#).

The Master OAW-IAP will send the WLSXIAPVOICECLIENTLOCATIONUPDATE SNMP trap under the following scenarios:

- The VoIP call is successful.
- The VoIP client roams from one OAW-IAP to another during an active call, the Master OAW-IAP will identify the VoIP client and send out the WLSXIAPVOICECLIENTLOCATIONUPDATE trap to the emergency call server.



The trap sending feature is not supported for L3 mobility.

The WLSXIAPVOICECLIENTLOCATIONUPDATE trap contains the following information:

Table 96: *SNMP Trap Details for VoIP Calls*

Parameter	Description
wlsxTrapVcIpAddress	IP address of the VoIP client.
wlsxTrapVcMacAddress	MAC address of the VoIP client.
wlsxTrapAPMacAddress	MAC address of the OAW-IAP which generated the trap.
wlsxTrapAPName	Name of the OAW-IAP which generated the trap.

SNMP GET

In order to find the location of a particular emergency caller, the third-party SNMP server sends a query to the Master OAW-IAP using SNMP GET. The Master OAW-IAP responds back to the SNMP server with the location (OAW-IAP Name) of the VoIP caller. Following are the key parameters in the response sent by the Master OAW-IAP:

- VoIP Client IP Address
- VoIP Client MAC Address
- OAW-IAP MAC Address
- OAW-IAP Name

Wi-Fi Calling

Wi-Fi calling service allows cellular users to make or receive calls using a Wi-Fi network instead of using the cellular network of the carrier. The users can make or receive calls, and send text messages even when they are beyond a cellular coverage but have a Wi-Fi network coverage. Most major carriers around the world support Wi-Fi calling service.

Wi-Fi Calling Operation

At a high level, this is how Wi-Fi calling operates:

1. Wi-Fi Calling-capable handset initiates a DNS query to locate the evolved Packet Data Gateway (ePDG) of the carrier.
2. The handset establishes a persistent IPsec tunnel with ePDG.
3. Calls, text, and traffic for other services offered by the carrier are carried over in this IPsec tunnel.

Some carriers use a standard FQDN format for ePDG that includes their Mobile Network Code (MNC) and Mobile Country Code (MCC). For example, T-Mobile uses `ss.epdg.epc.mnc260.mcc310.pub.3gppnetwork.org`. Others follow a different standard format. For example, AT&T uses `epdg.epc.att.net`.

Wi-Fi Calling Configuration

The AOS-W Instant CLI allows you to enable the wi-fi calling service and also configure DNS patterns. The ACL in `access-rules` to allow IPSEC/IKE (4500 port) enables Wi-Fi calling.

In the CLI:

To enable Wi-Fi calling:

```
wlan access-rule rule any any match tcp 4500 4500 permit
```

To configure DNS patterns:

```
(Instant AP) (config)# wificall-dns-pattern <dns_pattern>
```

To view the list of IP addresses learned by the Wi-Fi calling client during the DNS learning phase:

```
(Instant AP)# show datapath dns-ip-learning
```

This chapter provides information on how to configure the following services on an OAW-IAP:

- [Configuring AirGroup on page 377](#)
- [Configuring an OAW-IAP for RTLS Support on page 386](#)
- [Configuring an OAW-IAP for ALE Support on page 388](#)
- [Managing BLE Beacons on page 389](#)
- [Clarity Live on page 391](#)
- [Cluster Security on page 407](#)
- [Configuring OpenDNS Credentials on page 393](#)
- [Integrating an OAW-IAP with Palo Alto Networks Firewall on page 393](#)
- [Integrating an OAW-IAP with an XML API Interface on page 395](#)
- [CALEA Integration and Lawful Intercept Compliance on page 399](#)

Configuring AirGroup

AirGroup provides a unique enterprise-class capability that leverages zero configuration networking to enable AirGroup services from mobile devices efficiently. Zero configuration networking enables service discovery, address assignment, and name resolution for desktop computers, mobile devices, and network services. It is designed for flat, single-subnet IP networks such as wireless networking at home. The users can register their personal devices and define a group of users who can share the registered devices. Administrators can register and manage an organization's shared devices such as printers and grant global access to each device, or restrict access according to the username, role, or user location.

In large universities and enterprise networks, it is common for devices to connect to the network across VLANs. As a result, user devices on a specific VLAN cannot discover a service that resides on another VLAN. As the addresses used by the protocol are link-scope multicast addresses, each query or advertisement can only be forwarded on its respective VLAN, but not across different VLANs. Broadcast and multicast traffic are usually filtered out from a WLAN network to preserve the airtime and battery life. This inhibits the performance of AirGroup services that rely on multicast traffic. AirGroup addresses this challenge with AirGroup technology.

The distributed AirGroup architecture allows each OAW-IAP to handle mDNS and DLNA queries and responses individually instead of overloading a network with these tasks. This results in a scalable AirGroup solution.

The AirGroup solution supports both wired and wireless devices. An AirGroup device can be registered by an administrator or a guest user.

1. The AirGroup administrator gives an end user the AirGroup operator role, which authorizes the user to register the client devices on the ClearPass Policy Manager platform.
2. OAW-IAPs maintain information for all AirGroup services. OAW-IAP queries ClearPass Policy Manager to map each device's access privileges to the available services and responds to the query made by a device based on contextual data such as user role, username, and location.

The following figure illustrates how AirGroup enables personal sharing of Apple devices:

Figure 15 AirGroup Enables Personal Device Sharing

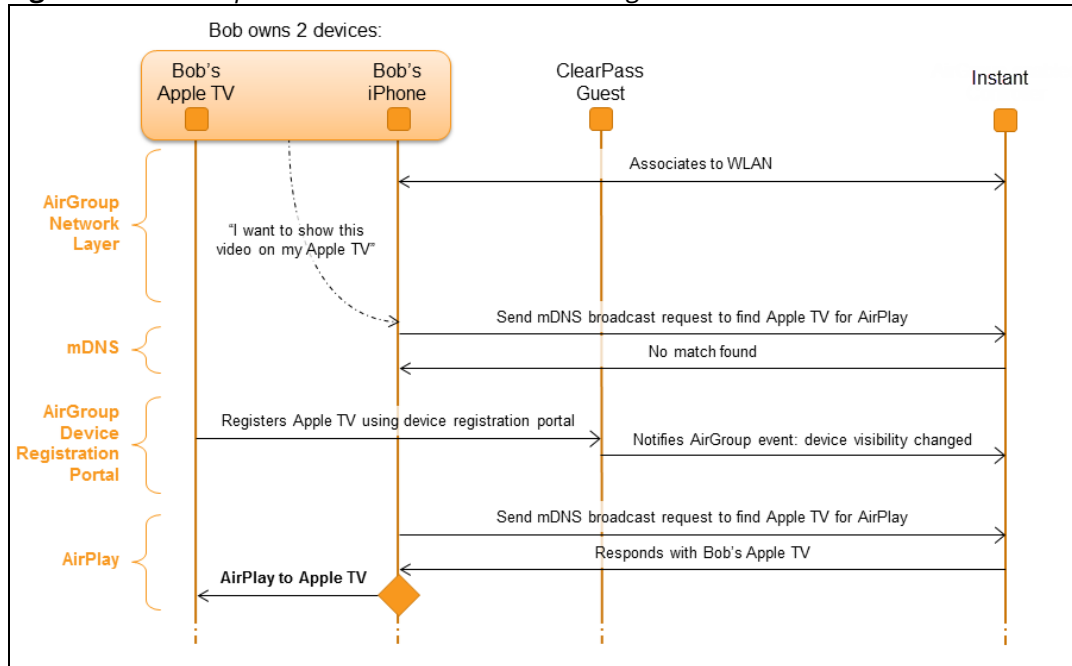

AirGroup is not supported on 3G and PPPoE uplinks.



For Apple TV mirroring to work, both Apple TV and users must be on either virtual switch-assigned VLANs or network-assigned VLANs. Otherwise, Apple TV mirroring will not work.

Multicast DNS and Bonjour® Services

Bonjour is the trade name for the zero configuration implementation introduced by Apple. It is supported by most of the Apple product lines, including the Mac OS X operating system, iPhone, iPod Touch, iPad, Apple TV, and AirPort Express. Apple AirPlay and AirPrint services are based on the Bonjour protocol and are essential services in campus Wi-Fi networks.

Bonjour can be installed on computers running Microsoft Windows® and is supported by the new network-capable printers. Bonjour is also included with popular software programs such as Apple iTunes, Safari, and iPhoto. Bonjour uses mDNS to locate devices and the services offered by these devices.

As shown in the following figure, the OAW-IAP1 discovers AirPrint (P1) and OAW-IAP3 discovers Apple TV (TV1). OAW-IAP1 advertises information about its connected P1 device to the other OAW-IAPs that is OAW-IAP2 and OAW-IAP3. Similarly, OAW-IAP3 advertises TV1 device to OAW-IAP1 and OAW-IAP2. This type of distributed architecture allows any OAW-IAP to respond to its connected devices locally. In this example, the iPad connected to OAW-IAP2 obtains direct response from the same OAW-IAP about the other Bonjour-enabled services in the network.

Figure 16 Bonjour Services and AirGroup Architecture

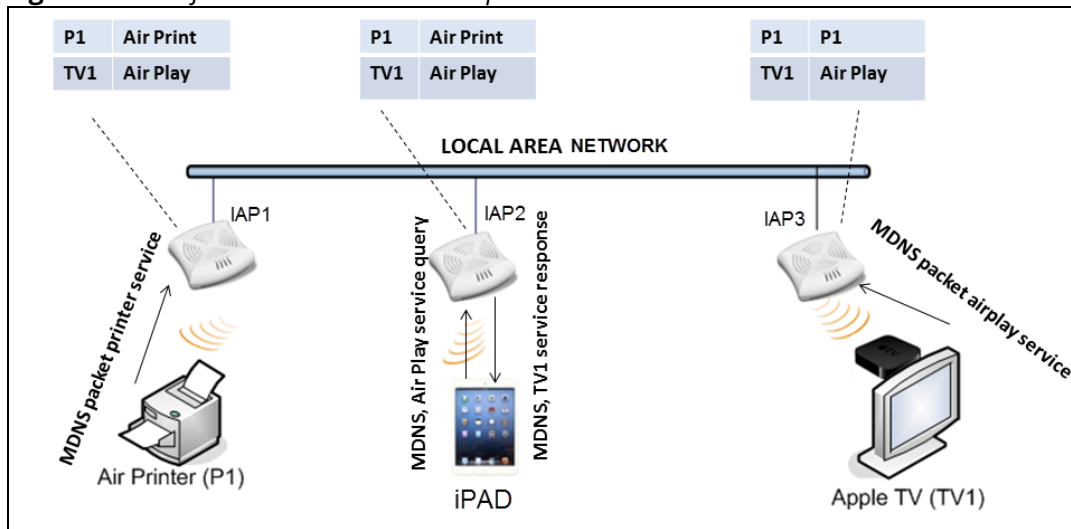

For a list of supported Bonjour services, see [AirGroup Services on page 381](#).

Multicast DNS Server Cache Age Out Behavior

When a mDNS wireless server disconnects abruptly from the OAW-IAP, the server entries and the server cache entries will be removed when the inactivity time reaches its threshold limit. The server and cache entries from other AOS-W Instants in the swarm will subsequently be removed once they receive an update from the database sync messages.

Users can configure the AirGroup wireless mDNS server cache to age out timer using the following command:

```
(Instant AP) (config)# wlan ssid-profile <inactivity-timeout>
```



This change is applicable only for wireless mDNS servers and not for DLNA servers or wired servers.

DLNA UPnP Support

In addition to the mDNS protocol, OAW-IAPs now support UPnP, and DLNA enabled devices. DLNA is a network standard derived from UPnP, which enables devices to discover the services available in a network. DLNA also provides the ability to share data between the Windows or Android-based multimedia devices. All the features and policies applicable to mDNS are extended to DLNA to ensure full interoperability between compliant devices.

In a UPnP-based scenario, the following types of devices are available in a network:

- Controlled devices (servers)
- Control points (clients)

When a controlled device joins a network and acquires IP address, it multicasts a number of discovery messages for advertising itself, its embedded devices, and services. On the other hand, when a control point joins a network, it may multicast a search discovery message for finding interesting devices and services. The devices listening on the multicast address respond if they match the search criteria in the search message.

In a single OAW-IAP network, the OAW-IAP maintains a cache table containing the list of discovered services in the network. The OAW-IAP also enforces native policies such as disallowing roles and VLANs and the policies defined on ClearPass Policy Manager to determine the devices or services that are allowed and can be discovered in the network. Whenever a search request comes, the OAW-IAP looks up its cache table and filters the cached data, based on configured policies, then builds a search response, and unicasts it to the requesting device.

In an OAW-IAP cluster, the OAW-IAPs maintain a list of associated UPnP devices and allow the discovery of the associated devices.

The following figure illustrates DLNA UPnP Services and AirGroup Architecture.

Figure 17 DLNA UPnP Services and AirGroup Architecture

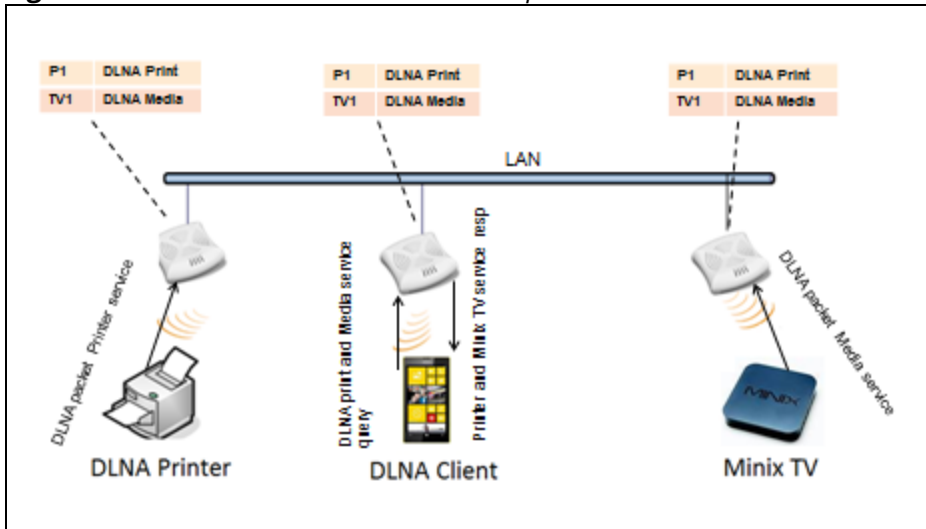

For a list of supported DLNA services, see [AirGroup Services on page 381](#).

AirGroup Features

AirGroup supports the following features:

- Sends unicast responses to mDNS or DLNA queries and reduces the traffic footprint.
- Ensures cross-VLAN visibility and availability of AirGroup devices and services.
- Allows or blocks AirGroup services for all users.
- Allows or blocks AirGroup services based on user roles.
- Allows or blocks AirGroup services based on VLANs.
- Matches devices to their closest services such as printers.
- In a multiple cluster scenario, when a client roams from one cluster to another, allowing or blocking of a service based on the user role or the VLAN depends upon configuration settings of the new cluster. For example, a user role is not allowed to access a service on one cluster but is allowed to access the same service on another cluster. In this case, the client will receive the configuration of the new cluster in which they can access the service.

AirGroup also enables context awareness for services across the network:

- AirGroup is aware of personal and shared devices. For example, an Apple TV in a dorm room can be associated with the student who owns it or an Apple TV in a meeting room or a printer in a supply room that is available to certain users, such as the marketing department.
- AirGroup is aware of the location of services when ClearPass Policy Manager support is enabled. For example, depending on the proximity, a user would be presented with the closest printer instead of all the printers in the building.
- When configured, AirGroup enables a client to perform a location-based discovery. For example, when a client roams from one AOS-W Instant cluster to another, it can discover devices available in the new cluster to which the client is currently connected.

The following figure shows an example of a higher-education environment with shared, local, and personal services available to mobile devices.

Figure 18 *AirGroup in a Higher-Education Environment*

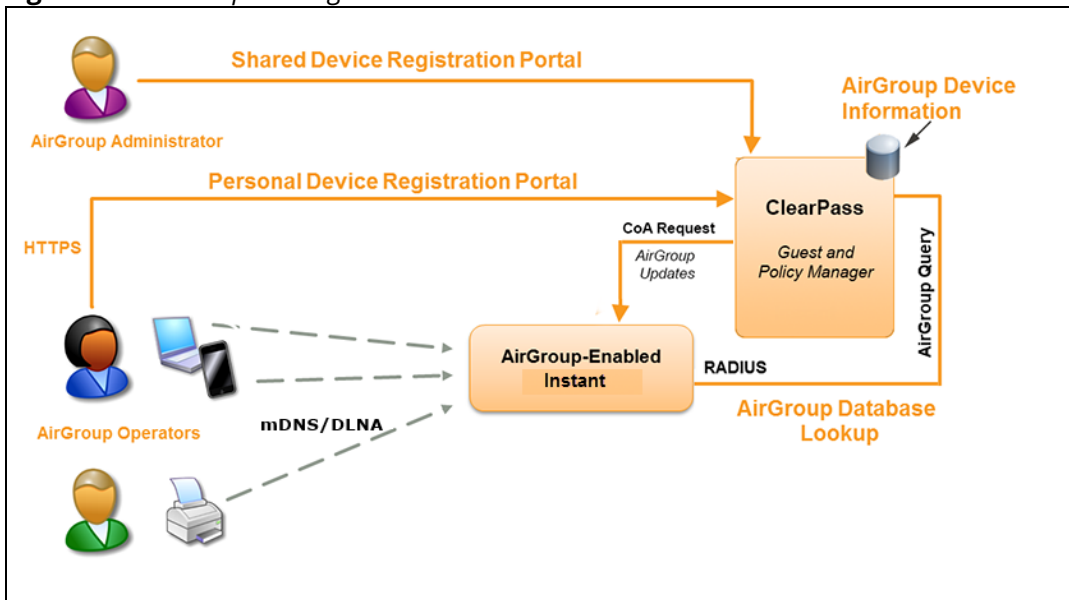

When AirGroup discovers a new device, it interacts with ClearPass Policy Manager to obtain the shared attributes such as shared location and role. However, the current versions of OAW-IAPs do not support the enforcement of shared location policy.

AirGroup Services

AirGroup supports zero configuration services. The services are preconfigured and are available as part of the factory default configuration. The administrator can also enable or disable any or all services by using the WebUI or the CLI.

The following services are available for OAW-IAP clients:

- **AirPlay™**—Apple® AirPlay allows wireless streaming of music, video, and slide shows from your iOS device to Apple TV® and other devices that support the AirPlay feature.
- **AirPrint™**—Apple AirPrint allows you to print from an iPad®, iPhone®, or iPod® Touch directly to any AirPrint-compatible printers.
- **iTunes**—The iTunes service is used by iTunes Wi-Fi sync and iTunes home-sharing applications across all Apple devices.
- **RemoteMgmt**—The RemoteMgmt service allows remote login, remote management, and FTP utilities on Apple devices.
- **Sharing**—The Sharing service allows applications such as disk sharing and file sharing among Apple devices.
- **ChromeCast**—The ChromeCast service allows you to use a ChromeCast device to play audio or video content on a high-definition television by streaming content through Wi-Fi from the Internet or local network.
- **DLNA Media**—Applications such as Windows Media Player use this service to browse and play media content on a remote device.
- **DLNA Print**—This service is used by printers that support DLNA.



In the AOS-W Instant 6.4.0.2-4.1.0.0 release, it is recommended to have a maximum of upto 80 AirGroup servers in the network.

For more information on configuring AirGroup services, see [Configuring AirGroup and AirGroup Services on an OAW-IAP on page 383](#).

AirGroup Components

AirGroup leverages key elements of the Alcatel-Lucent solution portfolio including operating system software for AOS-W Instant, ClearPass Policy Manager, and the VLAN-based or role-based filtering options offered by the AirGroup services. The components that make up the AirGroup solution include the OAW-IAP, ClearPass Policy Manager, and ClearPass Guest. The version requirements are described in the following table:

Table 97: OAW-IAP, ClearPass Policy Manager, and ClearPass Guest Requirements

Component	Minimum Version for mDNS Services	Minimum Version for DLNA Services
Instant Access Point	AOS-W Instant 6.2.0.0-3.2.0.0	AOS-W Instant 6.4.0.2-4.1.0.0
ClearPass Policy Manager software	ClearPass Policy Manager 5.2	ClearPass Policy Manager 6.2
ClearPass Guest Services plugin	ClearPass Guest 6.2.0	ClearPass Guest 6.3.0



Starting from ClearPass Policy Manager version 6.0, the ClearPass Guest and the AirGroup Services plug-in are integrated into a single platform.

AirGroup maintains seamless connectivity between clients and services across VLANs and SSIDs. The following table summarizes the filtering options supported by AOS-W Instant:

Table 98: AirGroup Filtering Options

Features	AOS-W Instant Deployment Models	
	Integrated with ClearPass Guest	Integrated with ClearPass Policy Manager
Allow mDNS and DLNA traffic to propagate across subnets or VLANs	Yes	Yes
Limit mDNS and DLNA traffic on the network	Yes	Yes
VLAN-based AirGroup service policy enforcement	Yes	Yes
User-role-based AirGroup service policy enforcement	Yes	Yes
Portal to self-register personal devices	No	Yes
Device-owner-based policy enforcement	No	Yes
Shared user-list-based policy enforcement	No	Yes
Shared role-list based-policy enforcement	No	Yes

ClearPass Policy Manager and ClearPass Guest Features

ClearPass Policy Manager and ClearPass Guest support the following features:

- Registration portal for WLAN users to register their personal devices.
- Registration portal for WLAN administrators to register shared devices.
- Operator-defined *personal* AirGroup to specify a list of other users who can share devices with the operator.
- Administrator-defined username, user role, and location attributes for shared devices.

Configuring AirGroup and AirGroup Services on an OAW-IAP

You can configure AirGroup services by using the WebUI or the CLI.

In the Old WebUI

To enable AirGroup and its services:

1. Click the **More > Services** link on the AOS-W Instant main window.
2. Click the **AirGroup** tab.
3. To enable support for Bonjour services, select the **Enable Bonjour** check box and select the AirGroup services related to Bonjour as required.
4. To enable DLNA support, select the **Enable DLNA** check box and select the DLNA services.
5. To allow the users to use Bonjour services enabled in a guest VLAN, select **Enable Guest Bonjour multicast**. When this check box is enabled, the Bonjour devices are visible only in the guest VLAN and AirGroup will not discover or enforce policies in guest VLAN.
6. Select the **Enable AirGroup across mobility domains** check box to enable inter-cluster mobility. When enabled, the OAW-IAP shares the mDNS database information with the other clusters. The DNS records in the virtual switch can be shared with all the virtual switch configured for L3 Mobility.
By default, this feature is disabled. To define clusters, go to the **System > L3 Mobility** tab.
7. Under **AirGroup Service**, ensure that the required AirGroup services are selected. To add any service, click **New** and add a service. To allow all services, select **allowall**. If a custom service is added, you can add a corresponding service ID by clicking **New** under **Service ID**.



NOTE

If an OAW-IAP is upgraded to the current release with the **Enable Bonjour** check box enabled, ensure that the corresponding Bonjour services are selected.

AOS-W Instant supports the use of up to 6 custom services.

8. Based on the services configured, you can block any user roles from accessing an AirGroup service and restrict the AirGroup servers connected to a specific set of VLANs from being discovered. The user roles and VLANs marked as disallowed are prevented from accessing the corresponding AirGroup service. You can create a list of disallowed user roles and VLANs for all AirGroup services configured on the OAW-IAP. For example,
 - If the AirPlay service is selected, the **edit** links for the **airplay disallowed roles** and **airplay disallowed vlans** are displayed. To block user roles from accessing an AirGroup service, click the corresponding **edit** link and select the user roles for which you want to restrict access. By default, an AirGroup service is accessible by all user roles configured in your OAW-IAP cluster.
 - Similarly, if sharing service is selected, the **edit** links for the **sharing disallowed roles** and **sharing disallowed vlans** are displayed. To block VLANs from allowing access to an AirGroup service, click the corresponding **edit** link and select the VLANs to exclude. By default, the AirGroup services are accessible by users or devices in all VLANs configured in your OAW-IAP cluster.

9. **ClearPass Settings**—Use this section to configure the ClearPass Policy Manager server, CoA server, and enforce ClearPass registering.

- **CPPM server 1**—Indicates the ClearPass Policy Manager server information for AirGroup policy.
- **Enforce ClearPass registration**—When enabled, only devices registered with ClearPass Policy Manager will be discovered by Bonjour devices, based on the ClearPass Policy Manager policy.

10. Click **OK**.

In the New WebUI

To enable AirGroup and its services:

1. Go to **Configuration > Services**.
2. Expand **AirGroup**.
3. To enable support for Bonjour services, toggle the **Enable Bonjour** switch to enable and select the AirGroup services related to Bonjour, as required.
4. To enable DLNA support, toggle the **Enable DLNA** switch to enable and select the DLNA services.
5. To allow the users to use Bonjour services enabled in a guest VLAN, toggle the **Enable Guest Bonjour multicast** switch to enable. When enabled, the Bonjour devices are visible only in the guest VLAN and AirGroup will not discover or enforce policies in guest VLAN.
6. Toggle the **Enable AirGroup across mobility domains** switch to enable inter-cluster mobility. When enabled, the OAW-IAP shares the mDNS database information with the other clusters. The DNS records in the virtual switch can be shared with all the virtual switch configured for L3 Mobility.
By default, this feature is disabled. To define clusters, go to **Configuration > System > L3 Mobility**.
7. Expand **AirGroup Settings**.
8. In the **AirGroup Service** section, select the required AirGroup services. To add a service, click **+**. To allow all services, select **allowall**. If a custom service is added in the **AirGroup Service** section, you can add a corresponding service ID by clicking **+** in the **Service ID** section.

If an OAW-IAP is upgraded to the current release with the **Enable Bonjour** toggle switch enabled, ensure that the corresponding Bonjour services are selected.



AOS-W Instant supports the use of up to 6 custom services.

9. Based on the services configured, you can block any user roles from accessing an AirGroup service and restrict the AirGroup servers connected to a specific set of VLANs from being discovered. The user roles and VLANs marked as disallowed are prevented from accessing the corresponding AirGroup service. You can create a list of disallowed user roles and VLANs for all AirGroup services configured on the OAW-IAP. For example,

- If the **airPlay** service is selected, an option to edit **Disallowed roles** and **Disallowed vlans** is displayed. To block user roles from accessing an AirGroup service, click the corresponding **edit** icon and select the user roles for which you want to restrict access. By default, an AirGroup service is accessible by all user roles configured in your OAW-IAP cluster.
- Similarly, if the **sharing** service is selected, an option to edit **Disallowed roles** and **Disallowed vlans** is displayed. To block VLANs from allowing access to an AirGroup service, click the corresponding **edit** icon and select the VLANs to exclude. By default, the AirGroup services are accessible by users or devices in all VLANs configured in your OAW-IAP cluster.

10. **ClearPass Settings**—Use this section to configure the ClearPass Policy Manager server, CoA server, and enforce ClearPass registration.

- **CPPM server 1**—Indicates the ClearPass Policy Manager server information for AirGroup policy.

- **Enforce ClearPass registration**—When enabled, only devices registered with ClearPass Policy Manager will be discovered by Bonjour devices, based on the ClearPass Policy Manager policy.

11. Click **Save**.

In the CLI

To configure AirGroup:

```
(Instant AP) (config)# airgroup
(Instant AP) (airgroup)# enable [dlna-only | mdns-only]
(Instant AP) (airgroup)# cppm enforce-registration
(Instant AP) (airgroup)# cppm-server <server>
(Instant AP) (airgroup)# cppm-query-interval <interval>
(Instant AP) (airgroup)# disallow-vlan <vlan-ID>
(Instant AP) (airgroup)# enable-guest-multicast
(Instant AP) (airgroup)# multi-swarm
```

To enable DLNA support:

```
(Instant AP) (config)# airgroup
(Instant AP) (airgroup)# enable dlna-only
```

To enable support for Bonjour services:

```
(Instant AP) (config)# airgroup
(Instant AP) (config)# enable mdns-only
```

To configure AirGroup services:

```
(Instant AP) (config)# airgroupservice <airgroup-service>
(Instant AP) (airgroup-service)# id <airgroupservice-ID>
(Instant AP) (airgroup-service)# description <text>
(Instant AP) (airgroup-service)# disallow-role <role>
(Instant AP) (airgroup-service)# disallow-vlan <vlan-ID>
```

To verify the AirGroup configuration status:

```
(Instant AP)# show airgroup status
```

Configuring AirGroup and ClearPass Policy Manager Interface in AOS-W Instant

Configure the AOS-W Instant and ClearPass Policy Manager interface to allow an AirGroup OAW-IAP and ClearPass Policy Manager to exchange information regarding device sharing, and location. The configuration options define the RADIUS server that is used by the AirGroup RADIUS client.

The AirGroup configuration with ClearPass Policy Manager involves the following steps:

1. [Create a RADIUS Server](#)
2. [Assign a Server to AirGroup](#)
3. [Configure ClearPass Policy Manager to Enforce Registration](#)
4. [Configuring CoA](#)

Creating a RADIUS Server

You can create a RADIUS server in the **AirGroup** window of the WebUI.

In the Old WebUI

1. Navigate to **More > Services > AirGroup**.
2. In the **ClearPass Settings** section, select **New** from the **CPPM server 1** drop-down list.
3. Configure the parameters are required.
4. Click **OK**.

In the New WebUI

1. Navigate to **Configuration > Services > AirGroup**.
2. To add a new RADIUS server, go to the **ClearPass Settings** section and click **+** beside the **CPPM server 1** drop-down list. If you want to choose from a list of available servers, select a server from the **CPPM server 1** drop-down list.
3. To create a new RADIUS server, click **+** and configure the parameters are required.
4. Click **OK**.
5. Click **Save**.

You can configure an external RADIUS Security window. For more information on configuring ClearPass Policy Manager server, see [Configuring an External Server for Authentication on page 198](#).

Assigning a Server to AirGroup

To associate the ClearPass Policy Manager server with AirGroup, select the ClearPass Policy Manager server from the **CPPM Server 1** drop-down list of the old WebUI.



If two ClearPass Policy Manager servers are configured, the CPPM server 1 acts as a primary server and the CPPM server 2 acts as a backup server.

After the configuration is complete, this particular server will be displayed in the **CPPM server 1** drop-down list. To view this server, go to **More > Services > AirGroup > ClearPass Settings > CPPM server 1** in the old WebUI.

To view this server in the new WebUI, go to **Configuration > Services > AirGroup > ClearPass Settings > CPPM server 1** or **CPPM server 2**.

Configuring ClearPass Policy Manager to Enforce Registration

When ClearPass Policy Manager registration is enforced, the devices registered with ClearPass Policy Manager will be discovered by Bonjour devices, based on the ClearPass Policy Manager policy.

Configuring CoA

When a RADIUS server is configured with CoA with the ClearPass Policy Manager server, the guest users are allowed to register their devices. For more information on configuring RADIUS server with CoA, see [Configuring an External Server for Authentication on page 198](#).

Configuring an OAW-IAP for RTLS Support

AOS-W Instant supports the real-time tracking of devices when integrated with the AMP or a third-party RTLS server such as Aeroscout RTLS server. With the help of the RTLS, the devices can be monitored in real time or through history.

You can configure RTLS by using the WebUI or the CLI.

In the Old WebUI

To configure Aruba RTLS:

1. Click the **More > Services** link on the AOS-W Instant main window.
2. Click the **RTLS** tab.
3. Under **Aruba**, select the **RTLS** check box to integrate AOS-W Instant with the AMP or Ekahau RTLS server.
4. Specify the IP address and port to which the location reports must be sent.
5. Specify the shared secret key in the **Passphrase** text box.

6. In the **Update** text box, specify the frequency at which the virtual switch can send updates to the RTLS server. You can specify a value within the range of 5–3600 seconds. The default value is 30 seconds.
7. Select the **Include unassociated stations** check box to send reports to the RTLS server about the stations that are not associated to any OAW-IAP.
8. Click **OK**.

To configure third-party RTLS such as Aeroscout:

1. Under **3rd party**, select the **Aeroscout** check box to send the RFID tag information to an AeroScout RTLS.
2. Specify the IP address and port number of the AeroScout server to which location reports must be sent.
3. Select the **Include unassociated stations** check box to send reports on the stations that are not associated to any OAW-IAP to the Aeroscout RTLS server.
4. Click **OK**.

In the New WebUI

To configure Aruba RTLS:

1. Go to the **Configuration > Services** page.
2. Expand **RTLS**.
3. Under **Instant**, toggle the **RTLS** switch to enable to integrate AOS-W Instant with the AMP or Ekahau RTLS server.
4. Specify the **IP address** and **Port** to which the location reports must be sent.
5. Specify the shared secret key in the **Passphrase** text box.
6. In the **Update** text box, specify the frequency at which the virtual switch can send updates to the RTLS server. You can specify a value within the range of 5–3600 seconds. The default value is 30 seconds.
7. Toggle the **Include unassociated stations** switch to enable to send reports to the RTLS server about the stations that are not associated to any OAW-IAP.
8. Click **Save**.

To configure third-party RTLS such as Aeroscout:

1. Under **3rd party**, toggle the **Aeroscout** switch to send the RFID tag information to an AeroScout RTLS.
2. Specify the **IP address** and **Port** number of the AeroScout server to which location reports must be sent.
3. Toggle the **Include unassociated stations** switch to enable to send reports on the stations that are not associated to any OAW-IAP to the Aeroscout RTLS server.
4. Click **Save**.

In the CLI

To configure OmniVista 3600 Air Manager RTLS:

```
(Instant AP) (config)# airwave-rtls <IP-address> <port> <passphrase> <seconds> include-unassoc-sta
```

To configure Aeroscout RTLS:

```
(Instant AP) (config)# aeroscout-rtls <IP-address> <port> include-unassoc-sta
```

Support RTLS Tags with Aruba Central???

Starting from Alcatel-Lucent AOS-W Instant 8.4.0.0, OAW-IAPs are capable of sending data from RTLS tags to Central??? thereby facilitating WLAN deployments that use an inbuilt RTLS protocol. With the help of Central???, you can now track the location of an asset without the use of an RTLS server.

Reporting RTLS Tags to Aruba Central???

The OAW-IAP maintains a dynamic list of the RTLS tags. When the OAW-IAP listens to a new chirp signal from a tag, it overrides the previous chirp signal and reports the latest data to Central???. The list of RTLS tags is then erased and the OAW-IAP prepares to maintain a new list of RTLS tags. You can also configure a specific interval during which the data from the RTLS tags should be reported to Central???.

You can configure an OAW-IAP to send RTLS tags to Central??? using the AOS-W Instant CLI. Additionally, you can view the list of RTLS tags and the debug logs for RTLS.

In the CLI:

To enable reporting RTLS tags to Central???:

```
(Instant AP) (config)# report-rtls-to-central
```

To set an interval for reporting RTLS tags to Central:

```
(Instant AP) (config)# report-rtls-to-central-interval <interval>
```

To view the list of RTLS tags:

```
(Instant AP)# show rtls-tags
```

To display the debug logs for the RTLS tags:

```
(Instant AP)# debug-rtls-logs
```

To view all RTLS related logs:

```
(Instant AP)# show rtls-logs
```

To view the RTLS logs from the OAW-IAP to Central???:

```
(Instant AP)# show log rtls-to-cloud
```

Configuring an OAW-IAP for ALE Support

The ALE is designed to gather client information from the network, process it, and share it through a standard API. The client information gathered by ALE can be used for business purposes by analyzing a client's Internet behavior such as shopping preferences.

ALE includes a location engine that calculates the associated and unassociated device location every 30 seconds by default. For every device on the network, ALE provides the following information through the Northbound API:

- Client username
- IP address
- MAC address
- Device type
- Application firewall data showing the destinations and applications used by associated devices
- Current location
- Historical location

ALE requires the OAW-IAP placement data to be able to calculate location for the devices in a network.

ALE with AOS-W Instant

The AOS-W Instant 6.3.1.1-4.0.0.0 release supports ALE. The ALE server acts as a primary interface to all third-party applications and the OAW-IAP sends client information and all status information to the ALE server.

To integrate OAW-IAP with ALE, the ALE server address must be configured on an OAW-IAP. If the ALE server is configured with a host name, the virtual switch performs a mutual certificated-based authentication with the ALE server before sending any information.

Enabling ALE Support on an OAW-IAP

You can configure an OAW-IAP for ALE support by using the WebUI or the CLI.

In the Old WebUI

Configuring ALE support:

1. Click **More > Services**.
2. Click the **RTLS** tab.
3. Under **Aruba**, select the **Analytics & Location Engine** check box.
4. In the **Server** text box, specify the ALE server name or IP address.
5. In the **Report interval** text box, specify the reporting interval within the range of 6–60 seconds. The OAW-IAP sends messages to the ALE server at the specified interval. The default interval is 30 seconds.
6. Click **OK**.

In the New WebUI

Configuring ALE support:

1. Click **Configuration > Services**.
2. Click **RTLS**.
3. In the **Instant** section, toggle the **Analytics & Location Engine** switch to enable.
4. In the **Auth Server** text box, specify the ALE server name or IP address.
5. In the **Report interval** text box, specify the reporting interval within the range of 6–60 seconds. The OAW-IAP sends messages to the ALE server at the specified interval. The default interval is 30 seconds.
6. Click **Save**.

In the CLI

To enable OAW-IAP integration with the ALE server:

```
(Instant AP) (config)# ale-server <server-name | IP-address>
(Instant AP) (config)# ale-report-interval <seconds>
```

Verifying ALE Configuration on an OAW-IAP

To view the configuration details:

```
(Instant AP)# show ale config
```

To verify the configuration status:

```
(Instant AP)# show ale status
```

Managing BLE Beacons

In AOS-W Instant 6.4.3.4-4.2.1.0, OAW-IAPs support Alcatel-Lucent BLE devices, such as BT-100 and BT-105, which are used for location tracking and proximity detection. The BLE devices can be connected to an OAW-IAP and are monitored or managed by a cloud-based BMC. The BLE Beacon Management feature allows you to configure parameters for managing the BLE beacons and establishing secure communication with the BMC. You can also configure the BLE operation modes that determine the functions of the built-in BLE chip in the OAW-IAP.

The BLE beacon management and BLE operation mode feature is supported on OAW-AP-303P, OAW-303 Series, OAW-318 Series, OAW-AP-374, OAW-AP-375, OAW-AP-377, OAW-AP-344, OAW-AP-345, OAW-AP203H, OAW-AP303H, OAW-AP203R, OAW-AP365/OAW-AP367, OAW-IAP207, OAW-IAP304/OAW-IAP305, OAW-IAP314/OAW-IAP315, OAW-IAP334/OAW-IAP335, OAW-APAP-324/OAW-AP325, OAW-IAP214/OAW-IAP215, and OAW-IAP224/OAW-IAP225 devices.



You can configure BLE operation modes and enable the BLE Beacon Management feature by using the WebUI or the CLI.

In the Old WebUI

Configuring BLE mode:

1. Click **More > Services**.
2. Click the **RTLS** tab. The tab details are displayed.
3. To manage the BLE devices using BMC, select **Manage BLE beacons**.
4. Enter the authorization token. The authorization token is a text string of 1–255 characters used by the BLE devices in the HTTPS header when communicating with the BMC. This token is unique for each deployment.
5. In **Endpoint URL**, enter the URL of the server to which the BLE sends the monitoring data.
6. Select any of the following options from the **BLE Operation Mode** drop-down list:

Table 99: BLE Operation Modes

Mode	Description
Beaconing	The built-in BLE chip of the OAW-IAP functions as an iBeacon combined with the beacon management functionality.
Disabled	The built-in BLE chip of the OAW-IAP is turned off. The BLE operation mode is set to Disabled by default.
DynamicConsole	The built-in BLE chip of the OAW-IAP functions in the beaconing mode and dynamically enables access to OAW-IAP console over BLE when the link to the LMS is lost. The dynamic console mode performs special error checks when the OAW-IAP experiences connectivity issues and decides if the BLE Console needs to be enabled.
PersistentConsole	The built-in BLE chip of the OAW-IAP provides access to the OAW-IAP console over BLE and also operates in the Beaconing mode.

7. Click **OK**.

In the New WebUI

Configuring BLE mode:

1. Go to **Configuration > Services**.
2. Expand **RTLS**.
3. To manage the BLE devices using BMC, toggle the **Manage BLE beacons** switch to enable.
4. Enter the **Authorization token**. The authorization token is a text string of 1–255 characters used by the BLE devices in the HTTPS header when communicating with the BMC. This token is unique for each deployment.
5. In **Endpoint URL**, enter the URL of the server to which the BLE sends the monitoring data.
6. Select any of the following options from the **BLE Operation Mode** drop-down list:

Table 100: BLE Operation Modes

Mode	Description
Beaconing	The built-in BLE chip of the OAW-IAP functions as an iBeacon combined with the beacon management functionality.
Disabled	The built-in BLE chip of the OAW-IAP is turned off. The BLE operation mode is set to Disabled by default.
DynamicConsole	The built-in BLE chip of the OAW-IAP functions in the beaconing mode and dynamically enables access to OAW-IAP console over BLE when the link to the LMS is lost. The dynamic console mode performs special error checks and decides if the BLE Console needs to be enabled.
PersistentConsole	The built-in BLE chip of the OAW-IAP provides access to the OAW-IAP console over BLE and also operates in the Beaconing mode.

7. Click **Save**.

In the CLI

To enable BLE beacon management:

```
(Instant AP) (config)# ble config <token> <url>
```

To configure a BLE operation mode:

```
(Instant AP) (config)# ble mode <opmode>
```

To view the BLE configuration details:

```
(Instant AP)# show ble-config
```

Clarity Live

OAW-IAP provides support for Inline Monitoring support using Clarity Live to identify client connectivity issues and sends user debug data to OmniVista 3600 Air Manager. The client connectivity issues can be a problem with the client, Radius Authentication, DHCP, DNS, or it can be delay in the network. Clarity Live is used to identify the root cause of the problem, this feature can be used.

Inline Monitoring

This functionality of Clarity Live helps diagnose client connectivity issues. It provides the network administrator or engineers with more information regarding the exact stage at which the client connectivity fails or provides data where the dhcp or radius server is slow.

The OAW-IAP collects all information related to user transitions like association, authentication, and dhcp. Then, the OAW-IAP sends these records to a management server like OmniVista 3600 Air Manager. The management server analyzes the data and concludes which dhcp or radius server was not working efficiently causing user connectivity issues. This enhancement allows the management server to isolate WLAN issues caused by external servers such as dhcp or radius.

HTTPS is the data transport protocol used to communicate basic statistics or state changes to OmniVista 3600 Air Manager. Inline Monitoring makes use of HTTPS to send the statistics to OmniVista 3600 Air Manager too.

The following events are used by OAW-IAP to send inline monitoring (Clarity Live) updates to OmniVista 3600 Air Manager:

- Authentication Failure Events—The statistics or updates shared as part of this event are related to the management frame. These frames are processed by STM and are collected in the user space.

- **DHCP Failure Events**—In scenarios where the DHCP Server does not respond, information about the failure of the event can be collected by the OAW-IAP with the help of Clarity Live and sent to OmniVista 3600 Air Manager. This functionality receives client DHCP transactions from the control plane.
- **DNS Failure Events**—The OAW-IAP measures the responsiveness of each DNS server with the help of Clarity Live. The monitoring includes minimum, maximum, and average response time of each DNS server. A maximum of 16 DNS servers can be monitored at a time and a maximum of 16 DNS server entries are made in the DNS table. If there are no queries from a particular DNS server for a long period of time, the DNS server entry can be removed and replaced with a new DNS server entry. The statistical data collected for the DNS server will be pushed to OmniVista 3600 Air Manager before the entry is replaced by a new DNS entry.
- **STA Failure Events**—The station passive monitor statistic is generated when enabled on the OAW-IAP. The OAW-IAP generate the data periodically for every 60 seconds and sends it to OmniVista 3600 Air Manager.



All of the above clarity configurations must be enabled or disabled at the same time whether if it is by the WebUI or the CLI. OmniVista 3600 Air Manager will drop the message even if one of the four stats is disabled.

You can configure an OAW-IAP to generate inline monitoring statistics by using the WebUI or the CLI.

In the Old WebUI

To enable Clarity Live for generating inline monitoring statistics:

1. Click **More > Services**.
2. Click **Clarity**. The configuration options for the Clarity group are displayed.
3. Select the **Inline DHCP stats** check box to enable the OAW-IAP to generate statistics and update messages for DHCP Failure Events.
4. Select the **Inline Sta stats** check box to enable the OAW-IAP to generate statistics and update messages for STA Failure Events.
5. Select the **Inline Auth stats** check box to enable the OAW-IAP to generate statistics and update messages for Authentication Failure Events.
6. Select the **Inline DNS stats** check box to enable the OAW-IAP to generate statistics and update messages for DNS Failure Events.
7. Click **OK**.

In the New WebUI

To enable Clarity Live for generating inline monitoring statistics:

1. Go to **Configuration > Services**.
2. Expand **Clarity**. The configuration options for the Clarity group are displayed.
3. Toggle the **Inline DHCP stats** switch to enable the OAW-IAP to generate statistics and update messages for DHCP Failure Events.
4. Toggle the **Inline Sta stats** switch to enable the OAW-IAP to generate statistics and update messages for STA Failure Events.
5. Toggle the **Inline Auth stats** switch to enable the OAW-IAP to generate statistics and update messages for Authentication Failure Events.
6. Toggle the **Inline DNS stats** switch to enable the OAW-IAP to generate statistics and update messages for DNS Failure Events.
7. Click **Save**.

In the AOS-W Instant CLI

To configure inline monitoring statistics using the CLI:

```
(Instant AP) (config)# clarity
(Instant AP) (clarity)# inline-auth-stats
(Instant AP) (clarity)# inline-dhcp-stats
(Instant AP) (clarity)# inline-dns-stats
(Instant AP) (clarity)# inline-sta-stats
```

Verify Clarity Configuration on OAW-IAP

The following command is used to view the status of the Inline Monitoring events:

```
(Instant AP)# show clarity config
```

The following command is used to view the history of the authentication events:

```
(Instant AP)# show clarity history auth
```

The following command is used to view the history of the DHCP events:

```
(Instant AP)# show clarity history dhcp
```

The following command is used to view the history of the DNS events:

```
(Instant AP)# show clarity history dns
```

Configuring OpenDNS Credentials

When configured, the OpenDNS credentials are used by AOS-W Instant to access OpenDNS to provide enterprise level content filtering. You can configure OpenDNS credentials by using the WebUI or the CLI.

In the Old WebUI

To configure OpenDNS credentials:

1. Click **More > Services > OpenDNS**.
2. Update the **Username** and **Password** text boxes to enable access to OpenDNS.
3. Click **OK** to apply the changes.

In the New WebUI

To configure OpenDNS credentials:

1. Click **Configuration > Services > OpenDNS**.
2. In the **Credentials for Connecting to OpenDNS** section, update the **Username** and **Password** text boxes to enable access to OpenDNS.
3. Click **Save** to apply the changes.

In the CLI

To configure OpenDNS credentials:

```
(Instant AP) (config)# opendns <username> <password>
```

Integrating an OAW-IAP with Palo Alto Networks Firewall

Palo Alto Networks next-generation firewall offers contextual security for all users for safe enabling of applications. A simple firewall beyond basic IP address or TCP port numbers only provides a subset of the enhanced security required for enterprises to secure their networks. In the context of businesses using social networking sites, legacy firewalls are not able to differentiate valid authorized users from casual social networking users.

The Palo Alto next-generation firewall is based on user ID, which provides many methods for connecting the users to sources of identity information and associating them with firewall policy rules. For example, it provides an option to gather user information from Active Directory or LDAP server.

Integration with AOS-W Instant

The functionality provided by the Palo Alto Networks firewall based on user ID requires the collection of information from the network. OAW-IAP maintains the network (such as mapping IP address) and user information for its clients in the network and can provide the required information for the user ID on Palo Alto Networks firewall. Before sending the user-ID mapping information to the Palo Alto Networks firewall, the OAW-IAP must retrieve an API key that will be used for authentication for all APIs.

OAW-IAP provides the User ID mapping information to the Palo Alto Networks firewall for integration. The client user id for authentication will not be sent to the Palo Alto Networks firewall unless it has a domain prefix. The OAW-IAP checks for the domain information in the client username for all login and logout requests sent to the Palo Alto Networks firewall. If the user id already has a domain prefix, OAW-IAP forwards the request to the Palo Alto Networks firewall. Otherwise, the static client domain configured in the Palo Alto Networks firewall profile will be prefixed to the user id and then sent to the Palo Alto Networks firewall.

OAW-IAP and Palo Alto Networks firewall integration can be seamless with the XML-API that is available with Palo Alto Networks-OS 5.0 or later.

To integrate an OAW-IAP with Palo Alto Networks user ID, a global profile is added. This profile can be configured on an OAW-IAP with Palo Alto Networks firewall information such as IP address, port, username, password, firewall-enabled or firewall-disabled status.

The OAW-IAP sends messages to Palo Alto Networks based on the type of authentication and client status:

- After a client completes the authentication and is assigned an IP address, OAW-IAP sends the **login** message.
- After a client is disconnected or dissociated from the OAW-IAP, the OAW-IAP sends a **logout** message.

Configuring an OAW-IAP for PAN integration

You can configure an OAW-IAP for Palo Alto Networks firewall integration by using the WebUI or the CLI.

In the Old WebUI

To configure Palo Alto Networks firewall integration in an OAW-IAP:

1. Click **More > Services**.
2. Click **Network Integration**. The Palo Alto Networks firewall configuration options are displayed.
3. Select the **Enable** check box to enable Palo Alto Networks firewall.
4. Provide the user credentials of the Palo Alto Networks firewall administrator in the **Username** and **Password** text boxes.
5. Enter the Palo Alto Networks firewall IP address.
6. In the **Port** text box, enter the port number within the range of 1–65,535. The default port is 443.
7. Specify the static **Client domain** to be mapped to the client User IDs that do not have a domain name of its own.
8. Click **OK**.

In the New WebUI

To configure Palo Alto Networks firewall integration in an OAW-IAP:

1. Navigate to **Configuration > Services**.
2. Expand **Network Integration**. The Palo Alto Networks firewall configuration options are displayed.

3. Toggle the **Enable** switch to enable Palo Alto Networks firewall.
4. Provide the user credentials of the Palo Alto Networks firewall administrator in the **Username** and **Password** text boxes.
5. Enter the Palo Alto Networks firewall IP address in the **IP address** field.
6. In the **Port** text box, enter the port number within the range of 1–65,535. The default port is 443.
7. Specify the static **Client domain** to be mapped to the client User IDs that do not have a domain name of its own.
8. Click **Save**.

In the CLI

To enable Palo Alto Networks firewall integration with the OAW-IAP:

```
(Instant AP) (config)# firewall-external-enforcement pan
(Instant AP) (firewall-external-enforcement pan)# enable
(Instant AP) (firewall-external-enforcement pan)# domain-name <name>
(Instant AP) (firewall-external-enforcement pan)# ip <ip-address>
(Instant AP) (firewall-external-enforcement pan)# port <port>
(Instant AP) (firewall-external-enforcement pan)# user <name> <password>
```

Integrating an OAW-IAP with an XML API Interface

The XML API interface provides options to create and execute user management operations seamlessly on behalf of the clients or users.

Integration with AOS-W Instant

The XML API interface allows you to send specific XML commands to an OAW-IAP from an external server. These XML commands can be used to customize OAW-IAP client entries. You can use the XML API interface to add, delete, authenticate, query, or blacklist a user or a client.

The user authentication is supported only for users authenticated by captive portal authentication and not for the dot1x-authentication users.



The user add operation performed by the XML API interface is only used to modify the role of an existing user and not to create a new user.

You can now use HTTP or HTTPS to post commands to OAW-IAP. The communication process using the XML API Interface is as follows:

- An API command is issued in XML format from the server to the virtual switch.
- The virtual switch processes the XML request and identifies where the client is and sends the command to the correct slave OAW-IAP.
- Once the operation is completed, the virtual switch sends the XML response to the XML server.
- Users can use the response and take appropriate action to suit their requirements. The response from the virtual switch is returned using the predefined formats.

Configuring an OAW-IAP for XML API integration

You can configure an OAW-IAP for XML API integration by using the WebUI or the CLI. OAW-IAP supports the configuration of up to 8 XML API server entries.

In the Old WebUI

Enabling XML API server entries:

1. Click **More > Services**.
2. Click **Network Integration**.
3. To add an XML API server, click **New**. The **New XML API Server** window is displayed.
4. Enter a name for the XML API Server in the **Name** text box.
5. Enter the subnet of the XML API Server in the **Subnet** text box.
6. Enter the subnet mask of the XML API Server in the **Mask** text box.
7. Enter a passcode in the **Passphrase** text box, to enable authorized access to the XML API Server.
8. Re-enter the passcode in the **Retype** box.
9. To add multiple entries, repeat the procedure.
10. Click **OK**.
11. To edit or delete the server entries, use the **Edit** and **Delete** buttons, respectively.

In the New WebUI

Enabling XML API server entries:

1. Go to **Configuration > Services**.
2. Expand **Network Integration**.
3. To add an XML API server, click + in the **XML API Server Configuration** section.
4. Enter a name for the XML API Server in the **Name** text box.
5. Enter the subnet of the XML API Server in the **Subnet** text box.
6. Enter the subnet mask of the XML API Server in the **Mask** text box.
7. Enter a passcode in the **Passphrase** text box, to enable authorized access to the XML API Server.
8. Re-enter the passcode in the **Retype** box.
9. To add multiple entries, repeat the procedure.
10. Click **OK**.
11. Click **Save**.
12. To edit or delete server entries, use the corresponding icons.

In the CLI

To enable XML API integration with the OAW-IAP:

```
(Instant AP) (config)# xml-api-server <xml_api_server_profile>
(Instant AP) (xml-api-server <profile-name>)# ip <subnet> [mask <mask>]
(Instant AP) (xml-api-server)# key <key>
```

Creating an XML API Request

You can now create an XML request with an appropriate authentication command and send it to the virtual switch through HTTPS post. The format of the URL to send the XML request is:

```
https://<virtualcontroller-ip>/auth/command.xml
```

- **virtualcontroller-ip**: The IP address of the virtual switch that will receive the XML API request
- **command.xml**: The XML request that contains the XML API command.

The format of the XML API request is:

```
xml=<aruba command="<XML API command">>
<options>Value</options>
...
```

```
<options>Value</options>
</aruba>
```

You can specify any of the following commands in the XML request:

Table 101: XML API Command

Parameter	Description
user_add	If the user entry is already present in the user table, the command will modify the entry with the values defined in the XML request. For an existing user, this command will update any value that is supplied, with an exception of IP and MAC address. Session time-out is only applicable to captive portal users.
user_delete	This command deletes an existing user from the user table of the virtual switch. NOTE: Do not use the user_delete command if the intention is to clear the association from the virtual switch user table. If the client is dual-stack, it re-inherits the authentication state from the IPv6 address. If not dual-stack, the client reverts to the initial role.
user_authenticate	This command authenticates against the server group defined in the captive portal profile. This is only applicable to captive portal users.
user_blacklist	This command blacklists a user from connecting to your network. This command uses the default blacklist timeout of 3600 seconds. There is no corresponding clear command.
user_query	This command fetches the status and details of a user connected to your network. A dual-stack client can be queried by any of its IPv4 or IPv6 addresses, but only the queried IP address is displayed in the output.

Each XML API command requires certain mandatory options to successfully execute the task. The list of all available options are:

Table 102: XML API Command Options

Parameter	Description	Range / Defaults
ipaddr	IP address of the user in IPv4 or IPv6 format.	—
macaddr	MAC address of the user in aa:bb:cc:dd:ee:ff format.	Enter MAC address with colon.
user	Name of the user.	64-character string
role	This option is used to change the role of an existing user. This option applies to user_add and user_delete commands only.	64-character string
password	The password of the user for authentication.	—
session_timeout	The role will be changed to a pre-auto role after session timeout.	—

Parameter	Description	Range / Defaults
authentication	Authentication method used to authenticate the message and the sender. You can use any of MD5, SHA-1 or clear text methods of authentication. This option is ignored if shared secret is not configured. It is, however, mandatory if it is configured.	
key	This is the encoded MD5 or SHA-1 hash of shared secret or plain text shared secret. This option is ignored if shared secret is not configured on the switch. The actual MD5 or SHA-1 hash is 16/20 bytes and consists of binary data. It must be encoded as an ASCII-based HEX string before sending. It must be present when the virtual switch is configured with an xml API key for the server. Encoded hash length is 32/40 bytes for MD5 or SHA-1.	
version	The version of the XML API interface available in the virtual switch. This is mandatory in all XML API requests.	Current version is XML API 1.0

SES-imagotag ESL System

Starting from Alcatel-Lucent AOS-W Instant 8.4.0.0, OAW-IAPs provide support for SES-imagotag's Electronic Shelf Label system. Electronic Shelf Label is used by various retailers to display the price of the products kept on retail shelves. SES-imagotag's Electronic Shelf Label system enables OAW-IAPs to configure ESL-Radio, ESL-Server, label, and client software. The ESL-Radio is a USB dongle that works on 2.4 GHz frequency band. The ESL-Server is a management system that controls product labeling and client software is the control center for all ESL-Servers. These centers help in controlling and executing various tasks such as changing images to labels, assigning tags, resetting labels, refreshing displays, switching to preloaded pages, and so on. By enabling and using ESL system, retail labeling becomes easier and efficient. Alcatel-Lucent OAW-IAPs integrated with SES-imagotag enable access to Wi-Fi and Electronic Shelf Label services simultaneously.

This functionality is supported only on OAW-AP303H, OAW-IAP304, OAW-IAP305, OAW-IAP314, OAW-IAP315, OAW-IAP324, OAW-IAP325, OAW-IAP334, OAW-IAP335, OAW-AP-344, OAW-AP-345, OAW-AP-514, and OAW-AP-515 access points.



NOTE

The hotplug of Electronic Shelf Label Dongle is supported only on the following platforms: OAW-AP303H, OAW-IAP304, OAW-IAP305, OAW-IAP314, OAW-IAP315, OAW-IAP324, OAW-IAP325, OAW-IAP334, and OAW-IAP335 access points.

You can configure sesimagotag's Electronic Shelf Label services by using the CLI.

In the CLI

To configure SES-imagotag's Electronic Shelf Label (ESL) system details:

```
(Instant AP) # sesimagotag-esl-profile
```

To view the status of SES-imagotag's Electronic Shelf Label configuration for an OAW-IAP:

```
(Instant AP) # show esl status
```

To view the status of Electronic Shelf Label Radio's (USB dongle) traffic:

```
(Instant AP) # show esl-radio status [name]
```

To view the status of the serial communication daemon process:

```
(Instant AP)# show log scd [count]
```

CALEA Integration and Lawful Intercept Compliance

LI allows the Law Enforcement Agencies to perform an authorized electronic surveillance. Depending on the country of operation, the service providers are required to support LI in their respective networks.

In the United States, service providers are required to ensure LI compliance based on CALEA specifications.

AOS-W Instant supports CALEA integration in a hierarchical and flat topology, mesh OAW-IAP network, the wired and wireless networks.



Enable this feature only if LI is authorized by a law enforcement agency.

CALEA Server Integration

To support CALEA integration and ensure LI compliance, you can configure the OAW-IAPs to replicate a specific or selected client traffic and send it to a remote CALEA server.

Traffic Flow from OAW-IAP to CALEA Server

You can configure an OAW-IAP to send GRE-encapsulated packets to the CALEA server and replicate client traffic within the GRE tunnel. Each OAW-IAP sends GRE encapsulated packets only for its associated or connected clients. The following figure illustrates the traffic flow from the OAW-IAP to the CALEA server.

Figure 19 IAP to CALEA Server

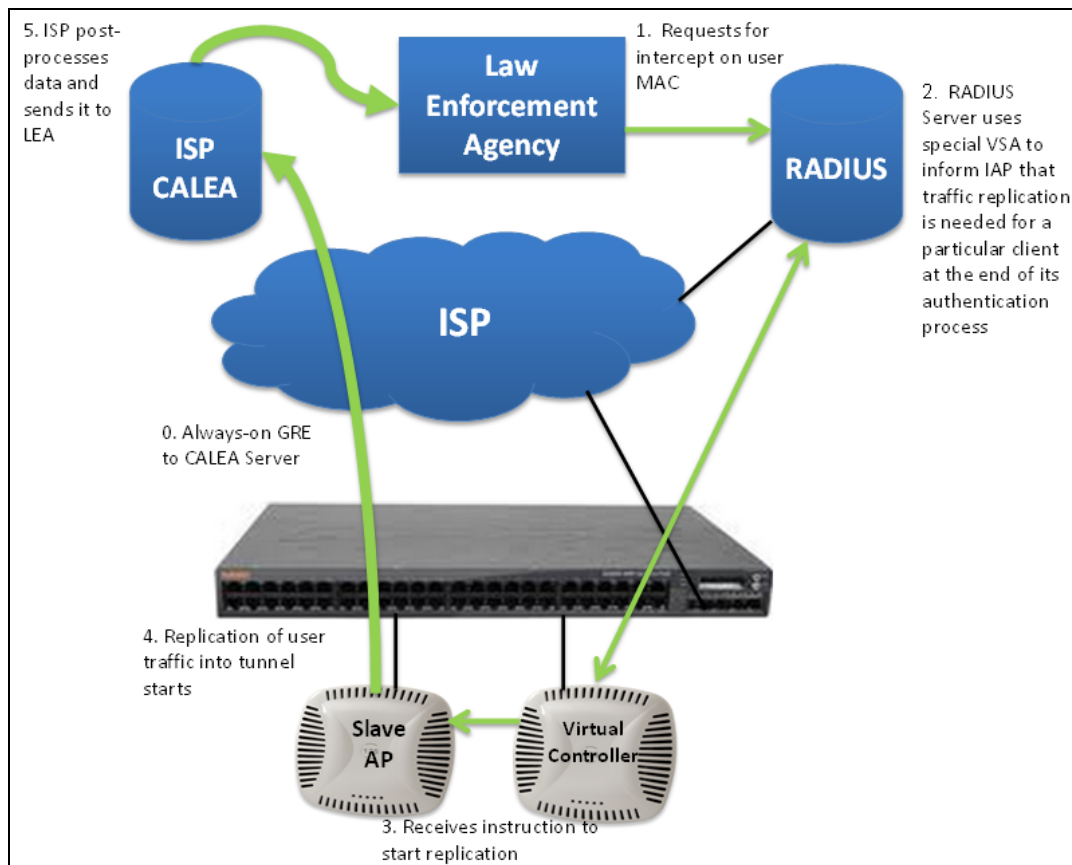

Traffic Flow from OAW-IAP to CALEA Server through VPN

You can also deploy the CALEA server with the switch and configure an additional IPsec tunnel for corporate access. When CALEA server is configured with the switch, the client traffic is replicated by the slave OAW-IAP and client data is encapsulated by GRE on slave, and routed to the master OAW-IAP. The master OAW-IAP sends the IPsec client traffic to the switch. The switch handles the IPsec client traffic while GRE data is routed to the CALEA server. The following figure illustrates the traffic flow from OAW-IAP to the CALEA server through VPN.

Figure 20 OAW-IAP to CALEA Server through VPN

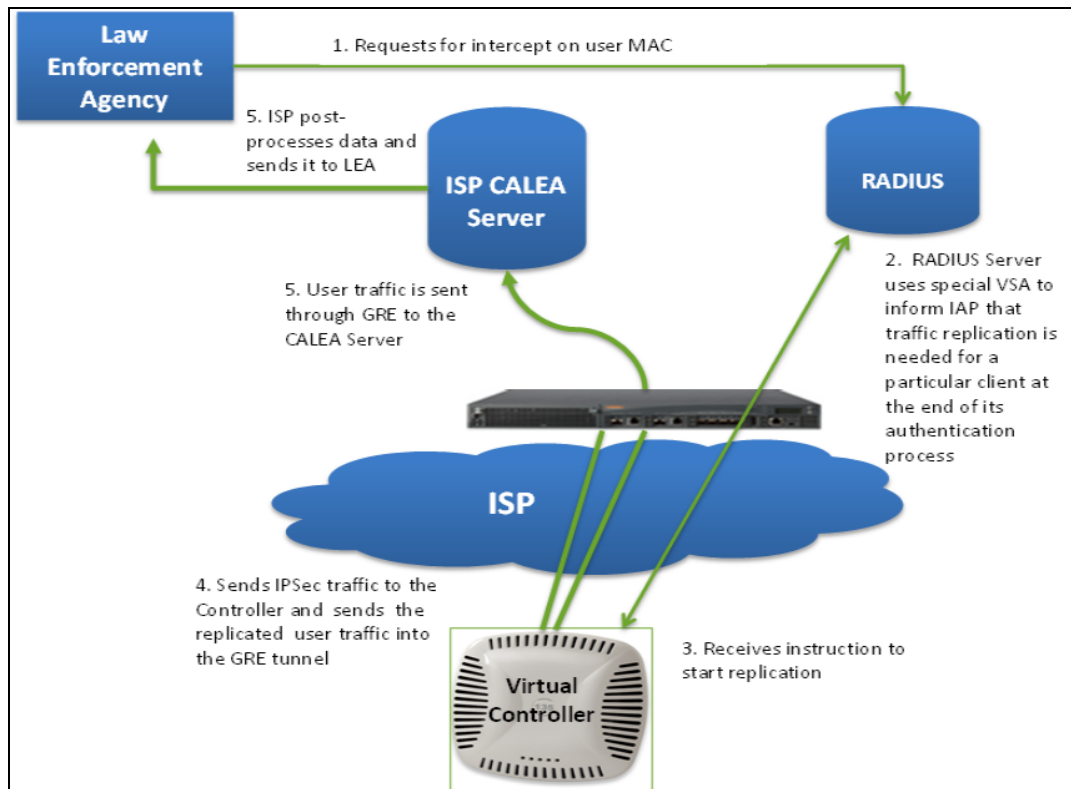

Ensure that IPsec tunnel is configured if the client data has to be routed to the ISP or CALEA server through VPN. For more information on configuring IPsec, see [Configuring an IPsec Tunnel on page 299](#).

Client Traffic Replication

Client traffic is replicated in the following ways:

- Through RADIUS VSA—In this method, the client traffic is replicated by using the RADIUS VSA to assign clients to a CALEA-related user role. To enable role assignment to clients, you need to create a user role and a CALEA access rule, and then assign the CALEA rule to the user role. Whenever a client that is configured to use a CALEA rule connects, a replication role is assigned.
- Through CoA—In this method, a user session can start without replication. When the network administrator triggers a CoA from the RADIUS server, the user session is replicated. The replication is stopped when the user disconnects or by sending a CoA to change the replication role.

As the client information is shared between multiple OAW-IAPs in a cluster, the replication rules persist when clients roam within the cluster.

Configuring an OAW-IAP for CALEA integration

To enable CALEA server integration, perform the following steps:

1. [Create a CALEA profile.](#)
2. If a replication role must be assigned through the RADIUS VSA, [create an access rule and assign the access rule to a WLAN SSID or wired profile.](#)
3. [Verify the configuration.](#)

Creating a CALEA Profile

You can create a CALEA profile by using the WebUI or the CLI.

In the Old WebUI

To configure a CALEA profile:

1. Click **More** > **Services** link on the AOS-W Instant main window.
2. Click **CALEA**.
3. Specify the following parameters:
 - **IP address**—Specify the IP address of the CALEA server.
 - **Encapsulation type**—Select the encapsulation type. The current release of AOS-W Instant supports GRE only.
 - **GRE type**—Specify the GRE type.
 - **MTU**—Specify a size for the MTU within the range of 68–1500. After GRE encapsulation, if packet length exceeds the configured MTU, IP fragmentation occurs. The default MTU size is 1500.
4. Click **OK**.

In the New WebUI

To configure a CALEA profile:

1. Go to **Configuration** > **Services**.
2. Expand **CALEA**.
3. Specify the following parameters:
 - **IP address**—Specify the IP address of the CALEA server.
 - **Encapsulation type**—Select the encapsulation type. The current release of AOS-W Instant supports GRE only.
 - **GRE type**—Specify the GRE type.
 - **MTU**—Specify a size for the MTU within the range of 68–1500. After GRE encapsulation, if packet length exceeds the configured MTU, IP fragmentation occurs. The default MTU size is 1500.
4. Click **Save**.

In the CLI

To create a CALEA profile:

```
(Instant AP) (config)# calea
(Instant AP) (calea)# ip <IP-address>
(Instant AP) (calea)# ip mtu <size>
(Instant AP) (calea)# encapsulation-type <gre>
(Instant AP) (calea)# gre-type <type>
```

Creating an Access Rule for CALEA

You can create an access rule for CALEA by using the WebUI or the CLI.

In the Old WebUI

To create an access rule:

1. To add a CALEA access rule to an existing profile:
 - a. Select an existing wireless network under **Networks** and click **edit** or,
 - b. Select a Wired profile in **More > Wired** and click **edit**.
2. To add an access rule to a new profile:
 - a. Click **New** under the **Networks** tab and create a WLAN profile or,
 - a. Click **More > Wired > New** and create a wired port profile.
3. In the **Access** tab, select the role for which you want create the access rule.
4. Under **Access Rules**, click **New**. The **New Rule** window is displayed.
5. Select **CALEA** as the **Rule type**.
6. Click **OK**.
7. Create a role assignment rule, if required.
8. Click **Finish**.

In the New WebUI

To create an access rule:

1. To add a CALEA access rule to an existing profile:
 - Select an existing wireless or wired network under **Configuration > Networks** and click **Edit**.
2. To add an access rule to a new profile:
 - Click **+** under the **Configuration > Networks** tab and create a WLAN or wired profile.
3. In the **Access** tab, select the role for which you want create the access rule.
4. Under **Access Rules for <network>**, click **+**. The **New Rule** window is displayed.
5. Select **CALEA** as the **Rule type**.
6. Click **OK**.
7. Create a role assignment rule, if required.
8. Click **Finish**.

In the CLI

To create a CALEA access rule:

```
(Instant AP) (config)# wlan access-rule <name>
(Instant AP) (Access Rule <name>)# calea
```

To assign the CALEA rule to a user role:

```
(Instant AP) (config)# wlan ssid-profile <name>
(Instant AP) (SSID Profile <name>)# set-role <attribute>{{equals | not-equals | starts-with|
ends-with | contains}<operator><role> | value-of}
```

To associate the access rule with a wired profile:

```
(Instant AP) (config)# wired-port-profile <name>
(Instant AP) (Wired ap profile <name>)# access-rule-name <name>
```

Verifying the configuration

To verify the CALEA configuration:

```
(Instant AP)# show calea config
```

To view the tunnel encapsulation statistics:

```
(Instant AP)# show calea statistics
```

Example

To enable CALEA integration:

```
(Instant AP) (config)# calea
```

To enable a CALE access rule:

```
(Instant AP) (config)# wlan access-rule ProfileCalea  
(Instant AP) (Access Rule "ProfileCalea")# calea
```

To assign the CALEA rule to user role:

```
(Instant AP) (config)# wlan ssid-profile Calea-Test  
(Instant AP) (SSID Profile"Calea-Test")# enable  
(Instant AP) (SSID Profile"Calea-Test")# index 0  
(Instant AP) (SSID Profile"Calea-Test")# type employee  
(Instant AP) (SSID Profile"Calea-Test")# essid QA-Calea-Test  
(Instant AP) (SSID Profile"Calea-Test")# opmode wpa2-aes  
(Instant AP) (SSID Profile"Calea-Test")# max-authentication-failures 0  
(Instant AP) (SSID Profile"Calea-Test")# auth-server server1  
(Instant AP) (SSID Profile"Calea-Test")# set-role Filter-Id equals 123456 calea-test  
(Instant AP) (SSID Profile"Calea-Test")# rf-band 5.0  
(Instant AP) (SSID Profile"Calea-Test")# captive-portal disable  
(Instant AP) (SSID Profile"Calea-Test")# dtim-period 1  
(Instant AP) (SSID Profile"Calea-Test")# inactivity-timeout 1000  
(Instant AP) (SSID Profile"Calea-Test")# broadcast-filter none  
(Instant AP) (SSID Profile"Calea-Test")# dmo-channel-utilization-threshold 90  
(Instant AP) (SSID Profile"Calea-Test")# local-probe-req-thresh 0  
(Instant AP) (SSID Profile"Calea-Test")# max-clients-threshold 64
```

To verify the configuration:

```
(Instant AP)# show calea config
```

```
calea-ip :10.0.0.5  
encapsulation-type :gre  
gre-type :25944  
ip mtu : 150
```

To view the tunnel encapsulation statistics:

```
(Instant AP)# show calea statistics
```

```
Rt resolve fail : 0  
Dst resolve fail: 0  
Alloc failure : 0  
Fragged packets : 0  
Jumbo packets : 263  
Total Tx fail : 0  
Total Tx ok : 263
```

BLE IoT for Data Communication

Alcatel-Lucent AOS-W Instant supports IoT applications through BLE which includes transport mechanisms (such as HTTPS POSTs, WebSockets, and UDP), payload encoding (such as JSON, Protobuf), payload content, and periodicity of information updates.

The APB reports data comprising advertisement and scan response frames from scanned IoT or BLE devices to the BLE daemon (BD) process that runs on an OAW-IAP. BD classifies the incoming messages based on the signature of known device types. Advertisement and scan response frames for unknown devices are stored in raw format, that is, the payload for each frame type is stored as a hexadecimal string, along with the RSSI value. BD maintains a database of IoT devices with attributes populated for known or classified devices and complete advertisement or scan frames for unclassified devices.

Alcatel-Lucent AOS-W Instant 8.4.0.0 introduces two new standardized endpoints—Telemetry HTTPS and Telemetry WebSocket. The message payload for these two standardized endpoints are constructed based on a published Telemetry JSON schema file and Protobuf format respectively. Additionally, AOS-W Instant supports two new device classes from EnOcean. With these new endpoints provide the capability of choosing multiple payload content from various device classes in the existing IoT transport profile.

- **Endpoint**—The following IoT endpoints are currently supported:
 - Telemetry HTTPS
 - Telemetry WebSocket
 - Authentication URL—JWT with Bearer, Cell Size, Threshold Attributes, and Age Out filter
 - Meridian Beacon Management
 - Meridian Asset Tracking
 - UID-Namespace Filter for Eddystone beacon protocol
 - URL Filter for Eddystone beacon protocol
 - ZF Openmatics.
- **Payload Content**—The payload content is the list of the classified devices that is sent to the endpoints.
 - Managed beacons—Contains the attributes that are recognized by Aruba-specific APB. Typically, these attributes are communicated to the Meridian Editor.
 - Managed Tags—Contains the asset tag MAC address, RSSI, MAC address of observer or APB and timestamp.
 - Eddystone
 - EnOcean Sensors
 - EnOcean Switches
 - iBeacon—Filter Attributes for iBeacon UUID
 - ZF Tags—Contains the attributes that are recognized for the ZF tags.
 - Unclassified
- **Payload Encoding**—The BLE daemon packages the payload to send to a particular endpoint.
 - JSON encoding for beacon management data
 - Protobuf encoding for asset tag data
- **Transport interval** : This indicates the time interval during which the data is sent from the BLE daemon to the BLE relay. The intervals are:
 - Asset tag RSSI data that occurs every 4 seconds from each OAW-IAP to Meridian.
 - The Alcatel-Lucent beacon management data that is Telemetry HTTPS, Telemetry WebSocket every 1800 seconds (30 minutes) as the data is mostly static.
- **Filter Attributes**—The filter attributes are used to configure a list of UUIDs as a beacon whitelist. All beacons with a UUID in the configured list are reported and others are ignored.
- **Cell Size**—The cell size defines a scanning scope, in meters, for the APB. The cell size does not have a default value. When the cell size is set a specific value and a beacon is observed outside the cell, the beacon is ignored.
- **Threshold Attributes**—The threshold attributes are used to track the movement inside the cell size. If a BLE device that is inside the cell size moves a distance that is less than the change threshold, then the device status is not updated to the server. However, if the BLE device moves a distance that is more than the change threshold, then the device status is reported to the server. With the right threshold value, you can benefit from avoiding unstable event reporting caused by RSSI dithering.
- **Out of Range Timeout**—The OAW-IAP maintains an IoT or BLE device table for all the scanned tags. When a tag is within the scan range of an OAW-IAP, the OAW-IAP observes the tag, and the tag periodically

broadcasts updates information like RSSI of the tag. If the tag loses its power and no longer broadcasts information, then the tag is aged out. When an OAW-IAP does not observe a tag for a period exceeding the timeout value (default value is 120 seconds), the OAW-IAP performs the following:

- When the tag is within the cell size and not heard within timeout value, then the OAW-IAP reports the tag as out of range.
- When the tag is not heard within 10 minutes, then the OAW-IAP deletes the tag from the IoT BLE device table.



Starting from AOS-W Instant 8.4.0.0, administrators can identify OAW-IAPs in Meridian applications based on their names as it is easier to associate an OAW-IAP's name with its location.

Configuring IoT Endpoints

An endpoint is a physical computing device that performs a task as part of an Internet-connected product or service. You can configure different endpoints for the IoT profile you select. Each profile can be used with different endpoints. You can configure IoT management profiles by using the WebUI or the CLI.

In the Old WebUI

To configure IoT endpoints:

1. Navigate to **More > Services > IoT**.
2. Under the **IoT Endpoints** section, click **New**. The **New IoT Endpoint** window will be displayed.
3. Update the **Name, Type, State, URL, Transport interval**, and **Authorization token** fields to create a new endpoint.
4. Click **OK**.

In the New WebUI

To configure IoT endpoints:

1. Navigate to **Configuration > Services > IoT**.
2. Under the **IoT Endpoints** section, click **+**. The **New IoT Endpoint** window will be displayed.
3. Update the **Name, Type, State, URL, Transport interval**, and **Authorization token** fields to create a new endpoint.
4. Click **OK**.
5. Click **Save**.

In the CLI

Execute the following command to configure the IoT endpoint:

```
(Instant AP) (config) # iot transportProfile <name>
```

Execute the following command to set the IoT profile application:

```
(Instant AP) (config) # iot useTransportProfile <Profile>
```

Execute the following command to view the IoT profile status:

```
(Instant AP)# show iot transportProfile
```

IoT and Third Party Server Integration

Alcatel-Lucent AOS-W Instant 8.4.0.0 introduces the integration of built-in IoT BLE messages with third party servers. This integration provides a flexible interface for users to build their own endpoint and service without meridian support. switches send messages received from OAW-IAP to the endpoints.

OAW-IAPs send messages and ensure that these messages from multiple OAW-IAPs arrive within the desired frame. The location engine needs only the latest set of messages from the OAW-IAP.

OAW-IAPs send JSON encoded messages every minute after which, a clean-up of the messages is not required.

OAW-IAPs maintain the current list of BLE or IoT devices. When OAW-IAPs detect a new sound from a beacon or an IoT device, they override the previous sound information in order to send only the latest sound information to the endpoint.

Universal Unique Identifier (UUID) Configuration

A universal unique identifier is a 128-bit number used to uniquely identify an object or an entity on the Internet. AOS-W Instant enables users to configure universal unique identifiers and these identifiers are used as beacon whitelists. All beacons with the universal unique identifier in the configured list are reported to the endpoints. The remaining beacons are ignored. You can use a separate login message with a configurable username and password to perform authentication for the ignored beacons.

You can configure UUIDs by using the CLI:

In the CLI

```
(Instant AP) (config) # iot transportProfile <name>  
(Instant AP) (IoT Transport Profile "name") # uuidFilter <filter>
```

This chapter describes cluster security and the procedure for configuring cluster security DTLS for secure communication. It includes the following topics:

- [Overview on page 407](#)
- [Enabling Cluster Security on page 408](#)
- [ZTP with Cluster Security on page 408](#)
- [Low Assurance Devices on page 409](#)
- [Cluster Security Debugging Logs on page 410](#)
- [Verifying the Configuration on page 411](#)

Overview

Cluster security is a communication protocol that secures control plane messages between AOS-W Instant access points. Control plane messages such as configuration, cluster join, and other messages distributed between the devices in a cluster are secured using this protocol. Cluster security operates on the UDP port 4434 and uses DTLS protocol to secure messages.

Cluster Security Using DTLS

Cluster security provides secure communication using DTLS. A DTLS connection is established between the OAW-IAPs communicating with each other in the cluster.

Following are some of the advantages of using DTLS for cluster security:

- Mutual authentication is done between the OAW-IAPs in a cluster using device certificate.
- Peer MAC address validation against **AP whitelist** can be enabled in the configuration.
- Control plane messages between cluster members are transmitted securely using the DTLS connection established.

If auto-join is enabled, backward compatibility and recovery of OAW-IAPs is allowed on ARUBA UDP port 8211. Messages required for image synchronization and cluster security DTLS state synchronization are the only messages allowed.

If auto-join is disabled, the MAC address of a peer OAW-IAP is verified against the **AP whitelist** during device certificate validation.



Locked Mode Slave OAW-IAP

A slave OAW-IAP with non-factory default configuration and DTLS enabled in that configuration is considered to be in locked mode of operation. These slave OAW-IAPs will not be able to join the existing non-DTLS cluster as backward compatibility and recovery is not allowed. This is done for security reasons.

To recover the slave OAW-IAPs in locked mode:

- Execute the **disable-cluster-security-dtls** action command on the slave OAW-IAP , or
- Factory reset the slave OAW-IAP.

Enabling Cluster Security

You can enable cluster security using the WebUI or the CLI. Ensure that the following pre-requisites are satisfied:

Pre-requisites

1. NTP server must be reachable—If internet is reachable, pool.ntp.org will be used by default, otherwise a static NTP server needs to be configured.
2. UDP port 4434 should be permitted.

In the Old WebUI

To enable cluster security:

1. Navigate to **System > General**.
2. Select **Enabled** from the **Cluster security** drop-down list.
3. Click **OK**.

In the New WebUI

To enable cluster security:

1. Navigate to **Configuration > System > General**.
2. Toggle the **Cluster security** switch to enable.
3. Click **Save**.



Reboot all the OAW-IAPs in the swarm for the configuration to take effect.

In the CLI:

To enable cluster security:

```
(Instant AP) (config)# cluster-security
(Instant AP) (cluster-security)# dtls
```

To disable cluster security DTLS:

```
(Instant AP) (config)# cluster-security
(Instant AP) (cluster-security)# no dtls
```

To change per module logging level of cluster security:

```
(Instant AP)# cluster-security logging module <module_name> log-level <level>
```

To set individual log level for each module:

```
(Instant AP)# cluster-security logging module <module_name> log-level-individual <level>
```

After enabling or disabling the cluster security option, ensure that the Config Sync Status is TRUE in the output of the show summary command, before rebooting the cluster.



Cluster security is not supported for L3 mobility.

ZTP with Cluster Security

In the earlier versions of Alcatel-Lucent AOS-W Instant, it was a criteria to disable DTLS on a cluster before provisioning OAW-IAPs through ZTP. The user had to enable DTLS on the cluster once again after ZTP was

complete, which proved to be a slightly cumbersome process. A slave OAW-IAP operating on an image that does not support DTLS could not join the cluster through ZTP. Starting from Alcatel-Lucent AOS-W Instant 8.4.0.0, certain enhancements have been made to allow a DTLS disabled slave OAW-IAP to join a DTLS enabled cluster through ZTP.

Adding Slave OAW-IAPs to DTLS Enabled Clusters

In order for ZTP to succeed when auto-join is disabled, the OAW-IAP should be added to the list of whitelist APs by Central??? or OmniVista 3600 Air Manager before it joins the cluster.

You can allow slaves to join a DTLS enabled cluster by using the OAW-IAP WebUI or CLI:

In the Old WebUI:

1. Navigate to **System > General** .
2. Select **Allow** from the Non-DTLS Slaves drop-down list.
3. Click **OK**.

In the New WebUI:

1. Navigate to **Configuration > System > General** .
2. Click **Show advanced options**.
3. Select **Allow** from the **Non-DTLS Slaves** drop-down list.
4. Click **Save**.

In the CLI:

The following command allows a slave OAW-IAP to join a DTLS enabled cluster:

```
(Instant AP) (config)# cluster-security
(Instant AP) (cluster-security)# no disallow-non-dtls-slaves
```

To prevent a DTLS disabled slave OAW-IAP from joining a DTLS enabled cluster:

```
(Instant AP) (config)# cluster-security
(Instant AP) (cluster-security)# disallow-non-dtls-slaves
```

To check if non-DTLS slave OAW-IAPs are allowed to join a DTLS enabled cluster:

```
(Instant AP)# show cluster-security
```

Low Assurance Devices

Most of the Alcatel-Lucent devices contain a TPM chip that securely stores keys and performs cryptographic operations. However, some devices do not have a TPM chip. So, the unique private keys for those devices are stored in flash. Therefore, the level of protection for the device reduces.

To overcome this challenge, AOS-W Instant has introduced a new PKI which issues device certificates to non-TPM devices. The device certificates consist of a policy OID indicating that they are issued by the PKI. Non-TPM devices are low assurance devices.

The following new features are introduced in the new PKI:

- SHA-256 is supported.
- Non-TPM devices can be listed in the policy server.
- Policies of new non-TPM OAW-IAPs can be updated.

A 256-bit random number generated by non-TPM devices is used to encrypt a private key that is unique to each device. The keys is encrypted by AES encryption. Non-TPM devices compress and store the encrypted

private key file and the certificate files in Flash. The private key is maintained in an encrypted format. APIs are provided to applications that use the private key.

You can allow low assurance devices by using the WebUI or the CLI:

In the Old WebUI

To allow low assurance devices to a cluster:

1. Navigate to **System > General**.
2. Click **Show advanced options**.
3. Select **Enabled** from the **Cluster security** drop-down list.
4. Select **Allow** from the **Low assurance PKI** drop-down list.
5. Click **OK**.

In the New WebUI

To allow low assurance devices to a cluster:

1. Navigate to **Configuration > System > General**.
2. Click **Show advanced options**.
3. Toggle the **Cluster security** switch to enable.
4. Select **Allow** from the **Low assurance PKI** drop-down list.
5. Click **Save**.

In the Instant CLI

```
(Instant AP) (config)# cluster-security
(Instant AP) (cluster-security)# allow-low-assurance-devices
```

When a DTLS connection is denied to low assurance OAW-IAPs, the connection will not be allowed even if the OAW-IAP is in the allowed OAW-IAP whitelist.

If a mixed mode cluster (combination of non-TPM OAW-IAPs and regular OAW-IAPs) is preferred, ensure to set the **low assurance devices** parameter to **allow**.



Zeroization of TPM Keys

Zeroization is a process that involves the erasing of sensitive parameters (electronically stored data, cryptographic keys, and critical security parameters) to prevent their disclosure when a device is compromised.

AOS-W Instant 8.4.0.0 introduces zeroization of TPM keys in FIPS-based OAW-IAPs under circumstances that present a threat to their integrity such as unauthorized removal of FIPS-based OAW-IAPs, evidence of tampering, and so on.

You can zeroize TPM keys by using the AOS-W Instant CLI:

In the CLI

```
(Instant AP)# zeroize-tpm-keys
```

Cluster Security Debugging Logs

Cluster security logging is organized into modules based on functionality. The following are the core modules which are useful and should be used for debugging:

peer—The peer module is used to log connection initiation, renegotiation, collision and active connection updates. The log-level should be set to **debug** level while debugging any issues.

conn—The connection module is used to log connection creation, establishment, data transfer and maintenance updates. The log-level should be set to **debug** level for debugging DTLS connection issues.

mcap—The module capture module is used to log messages sent and received to the socket. Set log-level to **debug** to log only control messages. Set log-level to **debug1** to log control and data messages.

The following command can be used to set per module logging level:

```
(Instant AP)# cluster-security logging module <module_name> log-level <level>
```

Once the log-level is set, logs can be viewed using:

```
(Instant AP)# show log papi-handler
```

Verifying the Configuration

The following show commands can be used to view the cluster security configuration:

To view current cluster security Configuration and running state

```
(Instant AP)# show cluster-security
```

To view the cluster security statistics:

```
(Instant AP)# show cluster-security stats
```

To view the cluster security connection table:

```
(Instant AP)# show cluster-security connections
```

To view the cluster security peers:

```
(Instant AP)# show cluster-security peers
```

To view the message handler process logs:

```
(Instant AP) # show log papi-handler <count>
```

This chapter provides information on provisioning, managing and monitoring OAW-IAPs from the the OmniVista 3600 Air Manager management server:

- [Managing an OAW-IAP from OmniVista 3600 Air Manager on page 412](#)
- [WebSocket Connection](#)

Managing an OAW-IAP from OmniVista 3600 Air Manager

OmniVista 3600 Air Manager is a powerful platform and easy-to-use network operations system that manages Alcatel-Lucent wireless, wired, and remote access networks, as well as wired and wireless infrastructures from a wide range of third-party manufacturers. With its easy-to-use interface, OmniVista 3600 Air Manager provides real-time monitoring, proactive alerts, historical reporting, as well as fast and efficient troubleshooting. It also offers tools that manage RF coverage, strengthen wireless security, and demonstrate regulatory compliance.

OmniVista 3600 Air Manager can be used to provision, manage, and monitor a multi-site deployment of AOS-W Instant networks. For example, if you have 100 retail offices that require AOS-W Instant to provide WLAN connectivity at each office, OmniVista 3600 Air Manager can be used to provision all the 100 offices from a central site. OmniVista 3600 Air Manager also provides the administrator with the ability to monitor these geographically dispersed AOS-W Instant networks using an OmniVista 3600 Air Manager server depending on the scalability recommendations for OmniVista 3600 Air Manager.

The OAW-IAPs communicate with OmniVista 3600 Air Manager using the HTTPS, XML, or WebSocket protocol. This allows an OmniVista 3600 Air Manager server to be deployed in the cloud across a NAT device, such as a router.

The OmniVista 3600 Air Manager features available in the AOS-W Instant network are described in the following sections:

Image Management

OmniVista 3600 Air Manager allows you to manage firmware updates on WLAN devices by defining a minimum acceptable firmware version for each make and model of a device. It remotely distributes the firmware image to the WLAN devices that require updates, and it schedules the firmware updates such that updating is completed without requiring you to manually monitor the devices.

The manual model can be used to upgrade the firmware. In this model, the user can manually start a firmware upgrade for each virtual switch or set the desired firmware preference per group of devices.

Resetting an OAW-IAP

A virtual switch is added to the OmniVista 3600 Air Manager database either on management mode or monitor mode based on the OmniVista 3600 Air Manager configuration.

An OAW-IAP device can be reset through OmniVista 3600 Air Manager in the **Managed** mode:

1. In the **Modify Devices** section, select the OAW-IAP devices you want to reset to factory-default by selecting the check box beside it.
2. From the **Change Device Group Folder** drop-down list, select **Factory Reset selected devices**.
3. Click the **Factory Reset** tab.



On resetting the OAW-IAP device from OmniVista 3600 Air Manager, all the configuration values will be set to default except for the **per-ap-settings** and **VC Key** value.

OAW-IAP and Client Monitoring

OmniVista 3600 Air Manager allows you to find any OAW-IAP or client on the wireless network and to see real-time monitoring views. These monitoring views can be used to aggregate critical information and high-end monitoring information.

In the OmniVista 3600 Air Manager UI, you can select either **Manage Read/Write** or **Monitor-only+Firmware Upgrades** as management modes. When the OmniVista 3600 Air Manager Management level is set to **Manage Read/Write**, the WebUI is in read-only mode. When the OmniVista 3600 Air Manager Management level is set to **Monitor-only+Firmware Upgrades**, the WebUI changes to the read-write mode.

With the latest version of OmniVista 3600 Air Manager, a new option in the AMP is available to put the OAW-IAP in config-only mode. In this mode, the OAW-IAP will receive the firmware upgrades and configurations, but will not send any statistics for monitoring. The load is reduced on OAW-IAP and OmniVista 3600 Air Manager and this assists in scaling OmniVista 3600 Air Manager effectively.

Template-Based Configuration

OmniVista 3600 Air Manager automatically creates a configuration template based on any of the existing OAW-IAPs, and it applies that template across the network as shown in the following figure. It audits every device on an ongoing basis to ensure that configurations never vary from the enterprise policies. It alerts you whenever a violation is detected and automatically repairs the incorrectly configured devices.

Figure 21 *Template-Based Configuration*

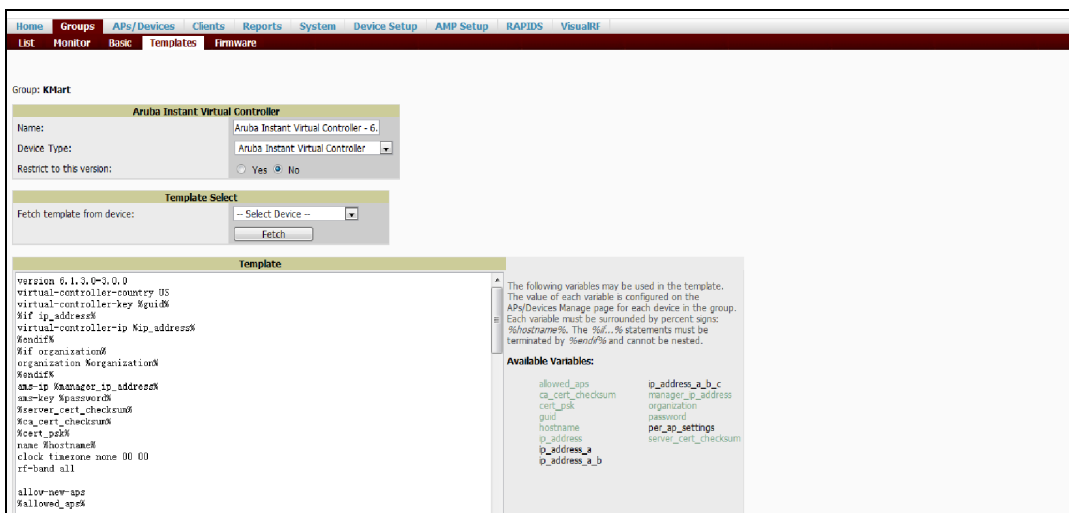

Trending Reports

OmniVista 3600 Air Manager saves up to 14 months of actionable information, including network performance data and user roaming patterns, so you can analyze how network usage and performance trends have changed over time. It also provides detailed capacity reports with which you can plan the capacity and appropriate strategies for your organization.

IDS

OmniVista 3600 Air Manager provides advanced, rules-based rogue classification. It automatically detects rogue OAW-IAPs irrespective of their location in the network and prevents authorized OAW-IAPs from being

detected as rogue OAW-IAPs. It tracks and correlates the IDS events to provide a complete picture of network security.

WIDS Event Reporting to OmniVista 3600 Air Manager

OmniVista 3600 Air Manager supports WIDS Event Reporting, which is provided by AOS-W Instant. This includes WIDS classification integration with the RAPIDS module. RAPIDS is a powerful and easy-to-use tool for automatic detection of unauthorized wireless devices. It supports multiple methods of rogue detection and uses authorized wireless OAW-IAPs to report other devices within range.

The WIDS report cites the number of IDS events for devices that have experienced the most instances in the prior 24 hours and provides links to support additional analysis or configuration in response.

RF Visualization Support for AOS-W Instant

OmniVista 3600 Air Manager supports RF visualization for AOS-W Instant. The VRF module provides a real-time picture of the actual radio environment of your wireless network and the ability to plan the wireless coverage of new sites. VRF uses sophisticated RF fingerprinting to accurately display coverage patterns and calculate the location of every Instant device in range. VRF provides graphical access to floor plans, client location, and RF visualization for floors, buildings, and campuses that host your network.

Figure 22 Adding an OAW-IAP in VRF

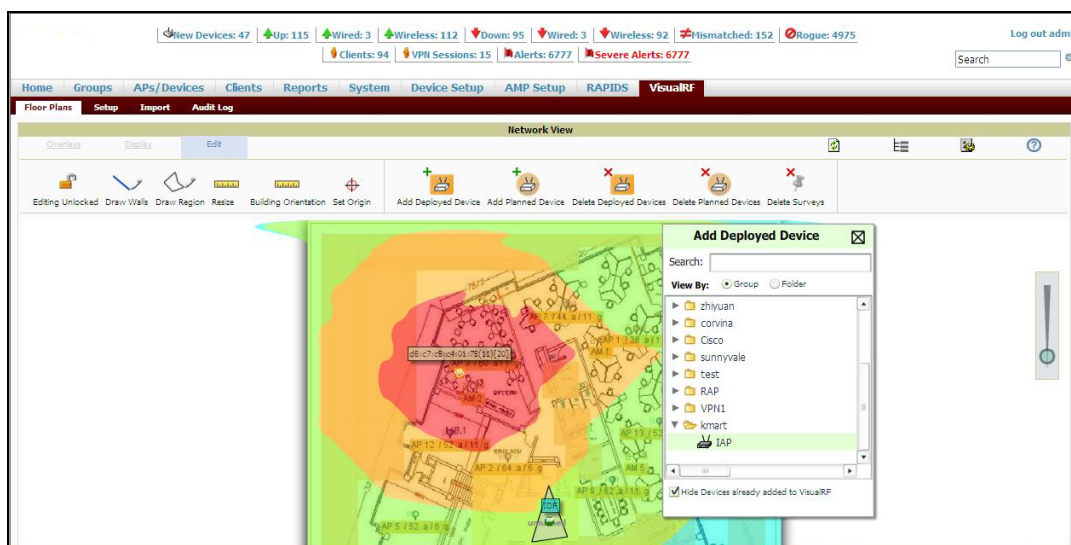

PSK-Based and Certificate-Based Authentication

The PSK-Based and Certificate-Based Authentication are determined by the AMP configuration field.

For a PSK-based authentication, the AMS-IP and PSK must be configured in the OAW-IAP. The virtual switch attempts to use the login message to initiate a connection.

For a Certificate-based authentication, the AMS-IP and the PSK or just the AMS hostname must be configured in the OAW-IAP. The OAW-IAP sends a login message to the AMP. The AMP responds with a randomly generated string. The OAW-IAP signs the string with its private key and certificate, and sends it back to the AMP. The AMP verifies if the certificate and signature are valid.

A virtual switch is approved based on the status of the Whitelist database:

- When Whitelist is enabled, the AMP verifies if the MAC address and serial number in the login message of the virtual switch and the whitelist database match. If they match, a virtual switch is created and approved. If they do not match, no virtual switch is created.

- When Whitelist is disabled, the virtual switch is created based on the following conditions:
 - Presence of other virtual switch with the same organization string and PSK in the AMP.
 - Approval of atleast one of the virtual switch in the AMP.

Configurable Port for OAW-IAP and OmniVista 3600 Air Manager Management Server Communication

You can now customize the port number of the AMP server through the **server_host:server_port** format, for example, **amp.aruba.com:4343**.

The following example shows how to configure the port number of the AMP server:

```
24:de:c6:cf:63:60 (config) # ams-ip 10.65.182.15:65535
```

Configuring Organization String

The Organization string is a set of colon-separated strings created by the OmniVista 3600 Air Manager administrator to accurately represent the deployment of each OAW-IAP. This string is defined by the installation personnel on the site.

You can use any of the following strings:

- AMP Role—"Org Admin" (initially disabled)
- AMP User—"Org Admin" (assigned to the role "Org Admin")
- Folder—"Org" (under the Top folder in AMP)
- Configuration Group—"Org"

You can also assign additional strings to create a hierarchy of subfolders under the folder named "Org". For example:

- subfolder1 for a folder under the "Org" folder
- subfolder2 for a folder under subfolder1

Shared Key

The Shared Secret key is an optional key used by the administrator to manually authorize the first virtual switch for an organization. Any string is acceptable.

The OmniVista 3600 Air Manager administrator can use a shared key to manually authorize the first virtual switch for an organization. Any string is acceptable, but this string must be the same for all devices in your organization.

The OmniVista 3600 Air Manager administrator sends the shared secret key, Organization String and the OmniVista 3600 Air Manager IP address to the on-site installer setting up the virtual switch and other AOS-W Instant devices on the network. The OmniVista 3600 Air Manager administrator then manually authorizes the virtual switch shared secret key when it appears in the **APs/Devices > New list**. After the virtual switch has been validated, other AOS-W Instant devices using that shared key will automatically be sent to the OmniVista 3600 Air Manager server, and appear in the **APs/Devices > New list**.

Configuring OmniVista 3600 Air Manager Information

You can configure OmniVista 3600 Air Manager information by using the WebUI or the CLI.

In the WebUI

To configure OmniVista 3600 Air Manager information:

1. Click the OmniVista 3600 Air Manager **Set Up Now** link of the main window. The **System** window is displayed with the OmniVista 3600 Air Manager parameters on the **Admin** tab.

2. Enter the name of your organization in the **Organization name** text box. The name defined for the organization is displayed under the **Groups** tab in the OmniVista 3600 Air Manager UI.
3. Enter the IP address or domain name of the OmniVista 3600 Air Manager server in the **AirWave server** text box.
4. Enter the IP address or domain name of a backup OmniVista 3600 Air Manager server in the **AirWave backup server** text box. The backup server provides connectivity when the primary server is down. If the OAW-IAP cannot send data to the primary server, the virtual switch switches to the backup server automatically.
5. Enter the shared key in the **Shared key** text box and reconfirm. This shared key is used for configuring the first OAW-IAP in the AOS-W Instant network.
6. Click **OK**.

In the CLI

To configure OmniVista 3600 Air Manager information:

```
(Instant AP) (config)# organization <name>
(Instant AP) (config)# ams-ip <IP-address or domain name>
(Instant AP) (config)# ams-backup-ip <IP-address or domain name>
(Instant AP) (config)# ams-key <key>
```

Configuring for OmniVista 3600 Air Manager Discovery Through DHCP

OmniVista 3600 Air Manager can be discovered through the DHCP server. You can configure this only if OmniVista 3600 Air Manager was not configured earlier or if you have deleted the precedent configuration.

On the DHCP server, the format for option 60 is "**ArubaInstantAP**". The two formats for option 43 are "**<organization>,<ams-ip>,<ams-key>**" and "**<organization>,<ams-domain>**" wherein you can configure any domain name.

If you use the **<organization>,<ams-ip>,<ams-key>** format, the PSK-based authentication is used to access the AMP server.

If you use the **<organization>,<ams-domain>** format, the OAW-IAP resolves the domain name into two IP addresses—OmniVista 3600 Air Manager Primary and OmniVista 3600 Air Manager Backup.



For option 43, when you choose to enter the domain name, the IP address and key are not available.

Enabling DNS-Based Discovery of the Provisioning AMP Server

OAW-IAPs can now automatically discover the provisioning AMP server if the DHCP option 43 and Activate cannot perform ZTP and transfer the OmniVista 3600 Air Manager configuration to the OAW-IAP.

When a domain option **xxx** is included in the DHCP configuration, the OAW-IAP will search the DNS server records for **aruba-airwave.xxx**. When there is no domain option, the OAW-IAP will search only the server records for **aruba-airwave**.



To enable OAW-IAPs to automatically discover the AMP server, create a DNS record for **aruba-airwave.xxx** or **aruba-airwave** in the DNS server. To use this feature on the OmniVista 3600 Air Manager side, enable certificate-based login. For information on how to enable certificate-based login, see [PSK-Based and Certificate-Based Authentication on page 414](#).

Standard DHCP Options 60 and 43 on Windows Server 2008

In networks that are not using DHCP options 60 and 43, it is easy to use the standard DHCP options 60 and 43 for an OAW-IAP or AP. For APs, these options can be used to indicate the master switch or the local switch. For

OAW-IAPs, these options can be used to define the OmniVista 3600 Air Manager IP, group, password, and domain name.

1. From a server running Windows Server 2008, navigate to **Server Manager > Roles > DHCP sever > domain > DHCP Server > IPv4**.
2. Right-click **IPv4** and select **Set Predefined Options**.

Figure 23 Instant and DHCP options for OmniVista 3600 Air Manager: Set Predefined Options

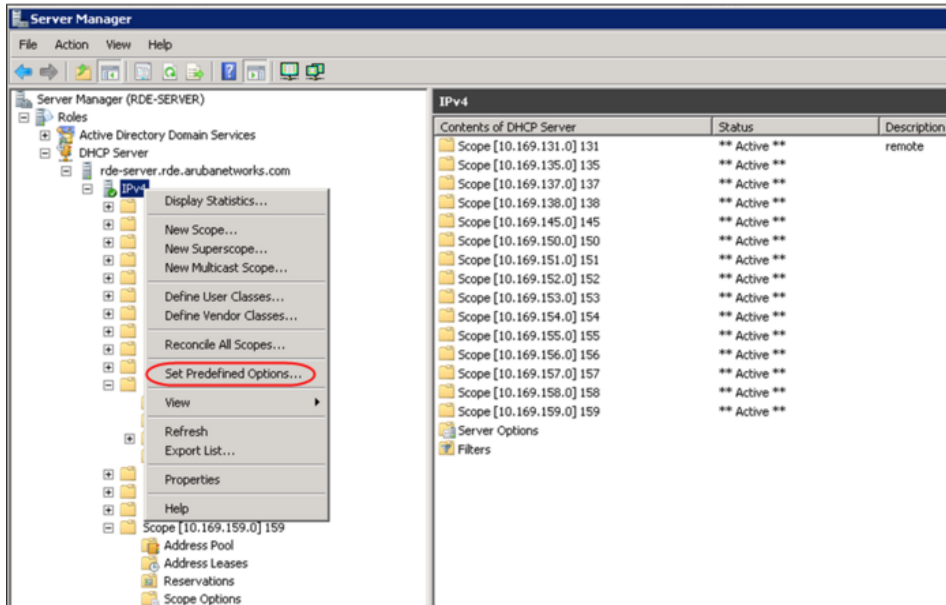

3. Select **DHCP Standard Options** in the **Option class** drop-down list and then click **Add**.
4. Enter the following information:
 - Name—AOS-W Instant
 - Data Type—String
 - Code—60
 - Description—AOS-W Instant AP

Figure 24 AOS-W Instant and DHCP options for OmniVista 3600 Air Manager: Predefined Options and Values

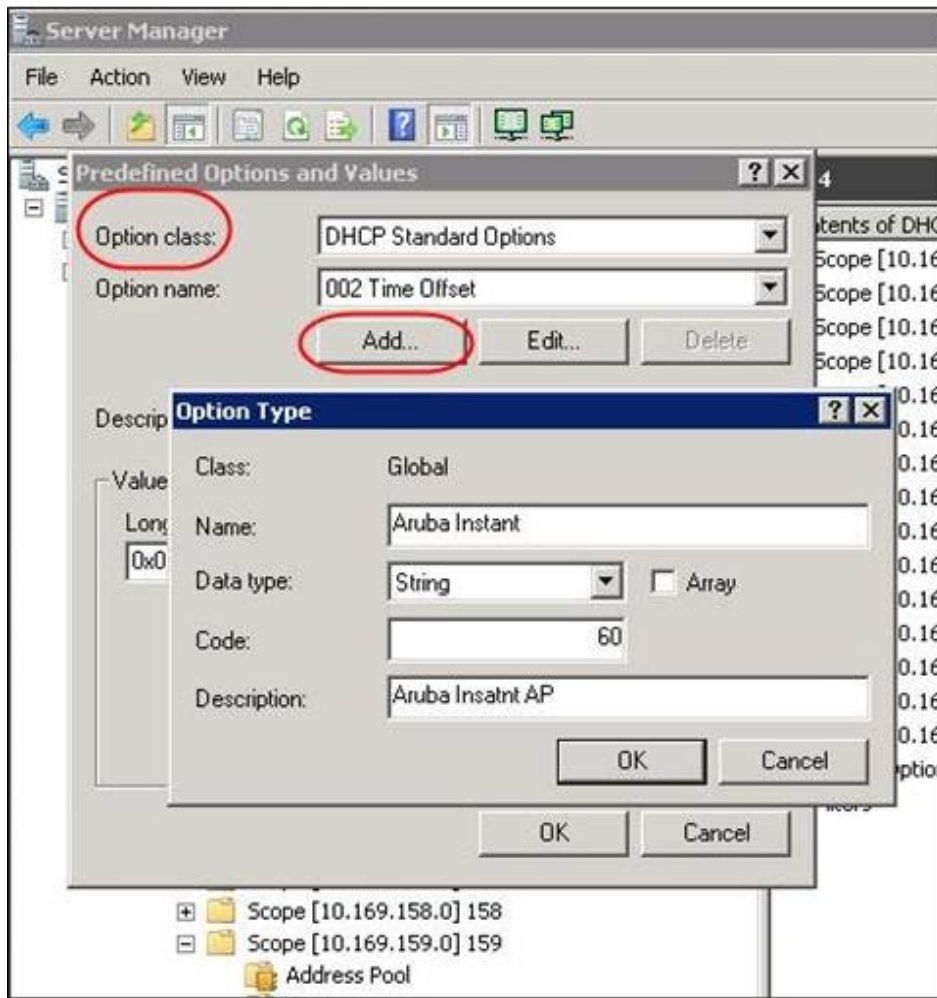

5. Navigate to **Server Manager** and select **Server Options** in the **IPv4** window. This sets the value globally. Use options on a per-scope basis to override the global options.
6. Right-click **Server Options** and select the configuration options.

Figure 25 AOS-W Instant and DHCP options for OmniVista 3600 Air Manager: Server Options

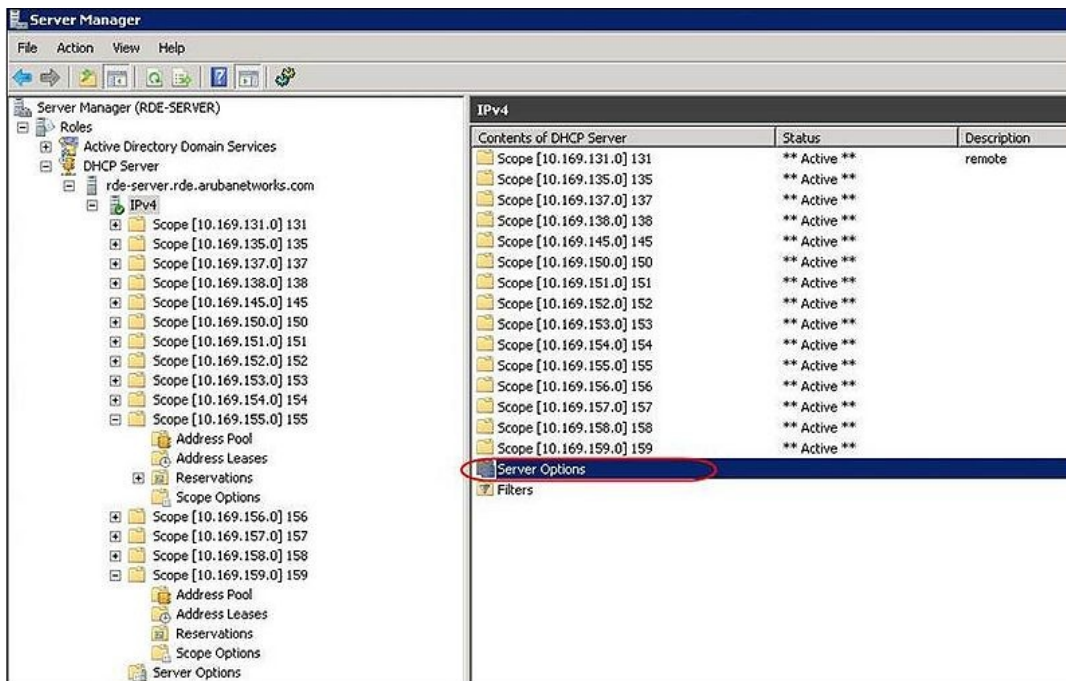

7. Select **060 Alcatel-Lucent Instant AP** in the **Server Options** window and enter **Alcatel-LucentInstantAP** in the **String value** text box.

Figure 26 AOS-W Instant and DHCP options for OmniVista 3600 Air Manager—060 OAW-IAP in Server Options

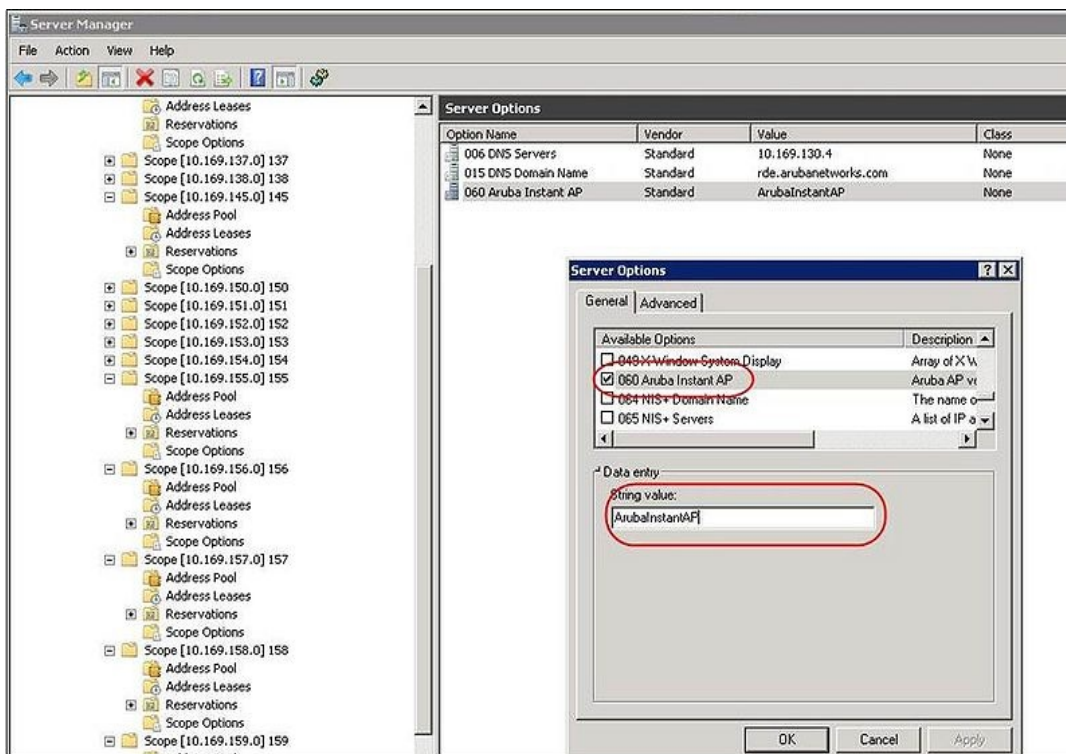

8. Select **043 Vendor Specific Info** and enter a value for either of the following in the ASCII text box:

- **airwave-orgn, airwave-ip, airwave-key**; for example: Alcatel-Lucent,192.0.2.20, 12344567
- **airwave-orgn, airwave-domain**; for example: Alcatel-Lucent, alcatellucent.support.com

Figure 27 AOS-W Instant and DHCP options for—043 Vendor-Specific Info

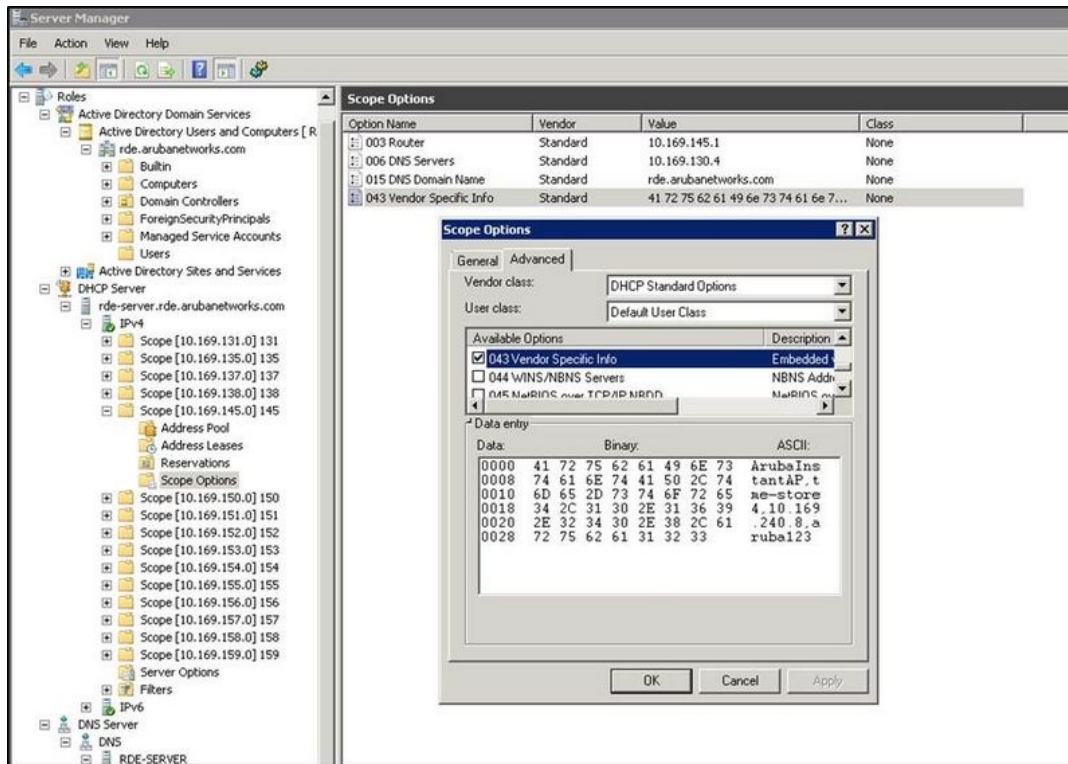

This creates DHCP options 60 and 43 on a global basis. You can do the same on a per-scope basis. The per-scope option overrides the global option.

Figure 28 AOS-W Instant and DHCP options for OmniVista 3600 Air Manager: Scope Options

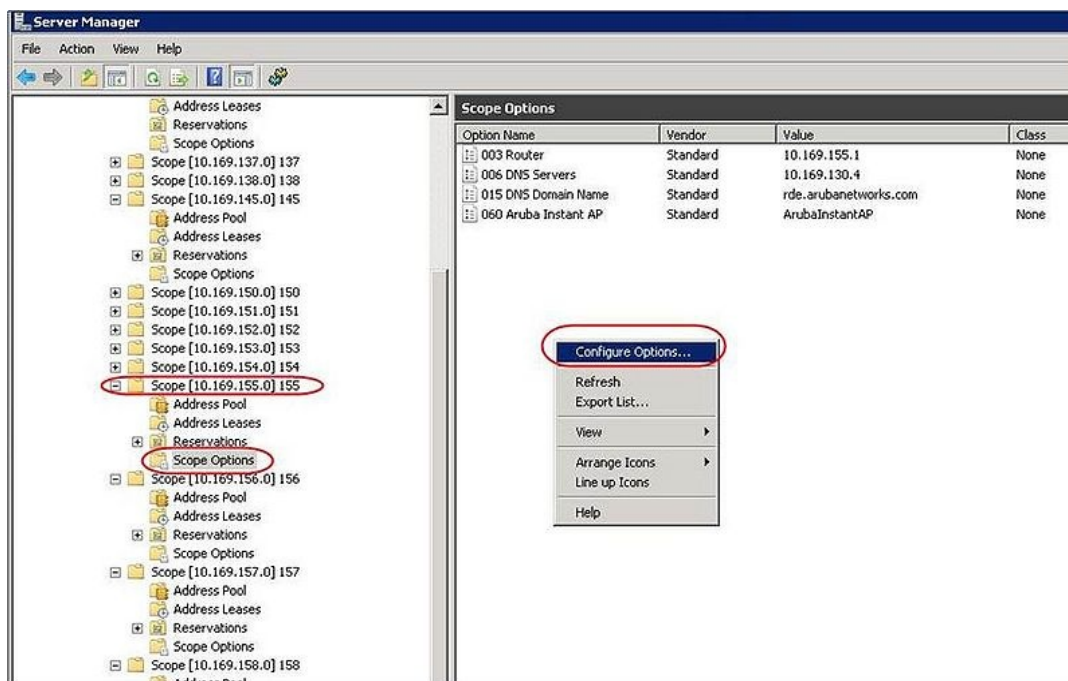

Alternate Method for Defining Vendor-Specific DHCP Options

This section describes how to add vendor-specific DHCP options for OAW-IAPs in a network that already uses DHCP options 60 and 43 for other services. Some networks use DHCP standard options 60 and 43 to provide

the DHCP clients information about certain services such as PXE. In such an environment, the standard DHCP options 60 and 43 cannot be used for OAW-IAPs.

This method describes how to set up a DHCP server to send option 43 with OmniVista 3600 Air Manager information to the OAW-IAP. This section assumes that option 43 is sent per scope, because option 60 is being shared by other devices as well.



The DHCP scope must be specific to AOS-W Instant, and the PXE devices that use options 60 and 43 must not connect to the subnet defined by this scope. This is because you can specify only one option 43 for a scope, and if other devices that use option 43 connect to this subnet, they are presented with the information specific to the OAW-IAP.

1. In Windows Server 2008, navigate to **Server Manager > Roles > DHCP Server > Domain DHCP Server > IPv4**.
2. Select a scope [subnet]. Scope [10.169.145.0]145 is selected in the example shown in the figure below.
3. Right-click and select **Advanced**, and then specify the following options:
 - Vendor class—DHCP Standard Options
 - User class—Default User Class
 - Available options—Select 043 Vendor-Specific Info
 - String Value—Alcatel-LucentInstantAP, tme-store4, 10.169.240.8, Alcatel-Lucent123 (which is the OAW-IAP description, organization string, OmniVista 3600 Air Manager IP address or domain name, PSK, for OmniVista 3600 Air Manager)

Figure 29 Vendor-Specific DHCP options

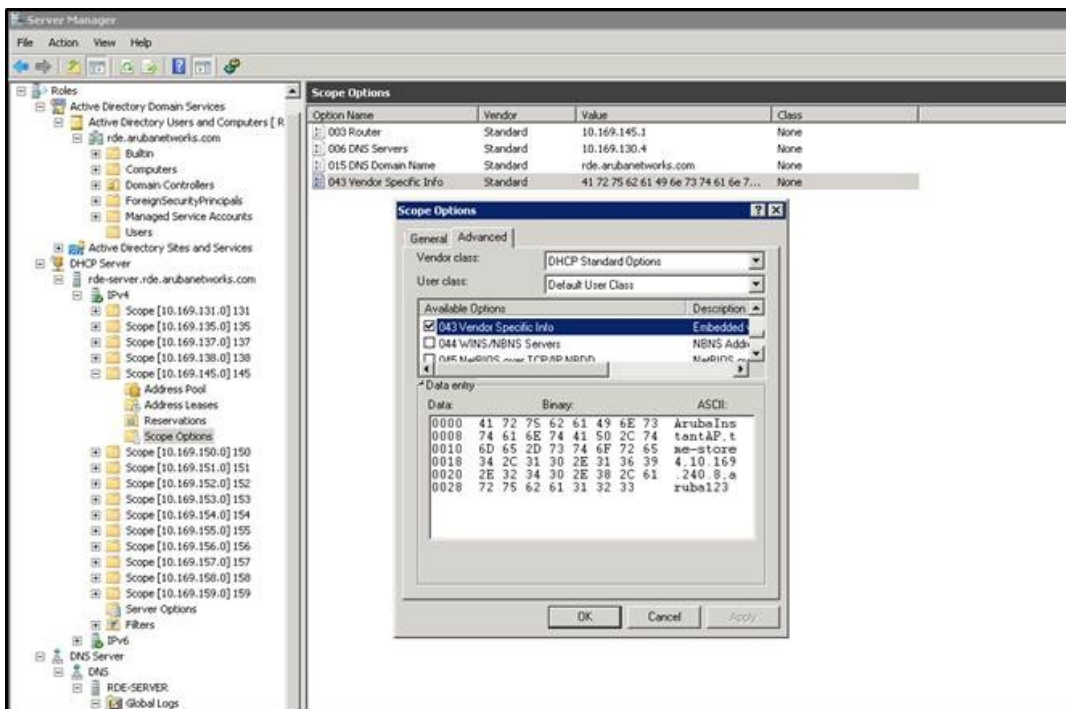

Upon completion, the OAW-IAP shows up as a new device in OmniVista 3600 Air Manager, and a new group called **tme-store4** is created. Navigate to **APs/Devices > New > Group** to view this group.

Figure 30 *OmniVista 3600 Air Manager—New Group*

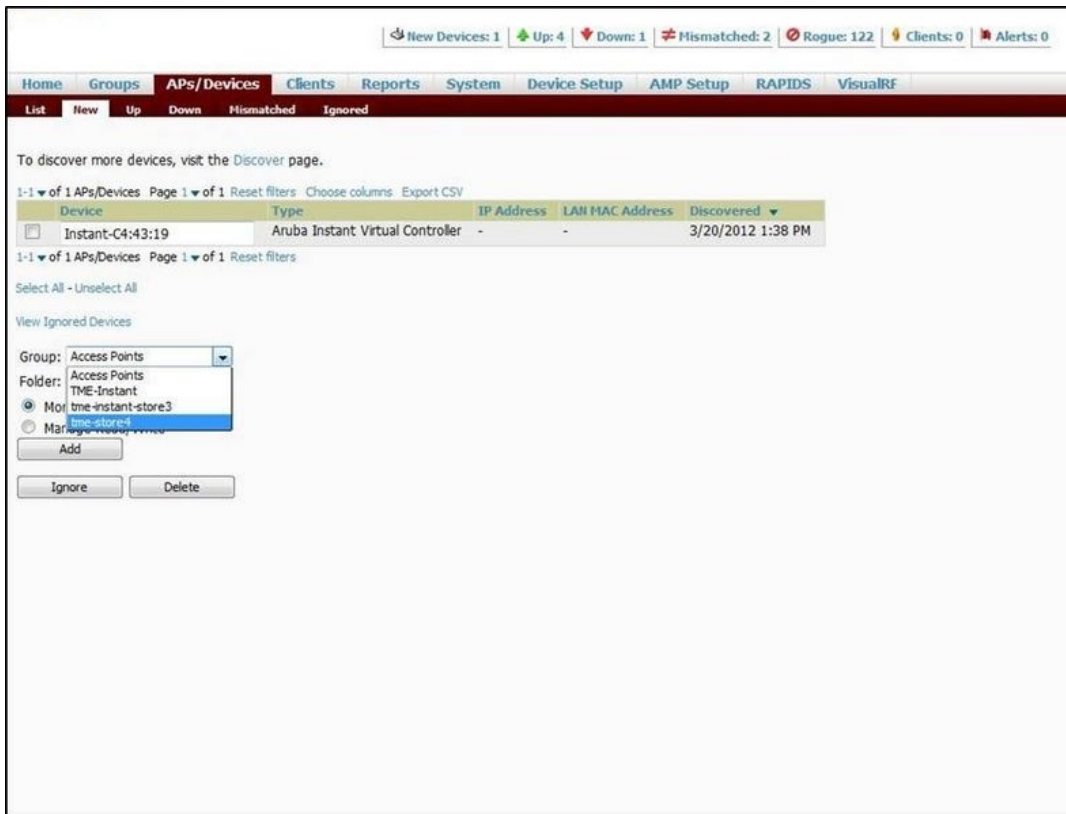
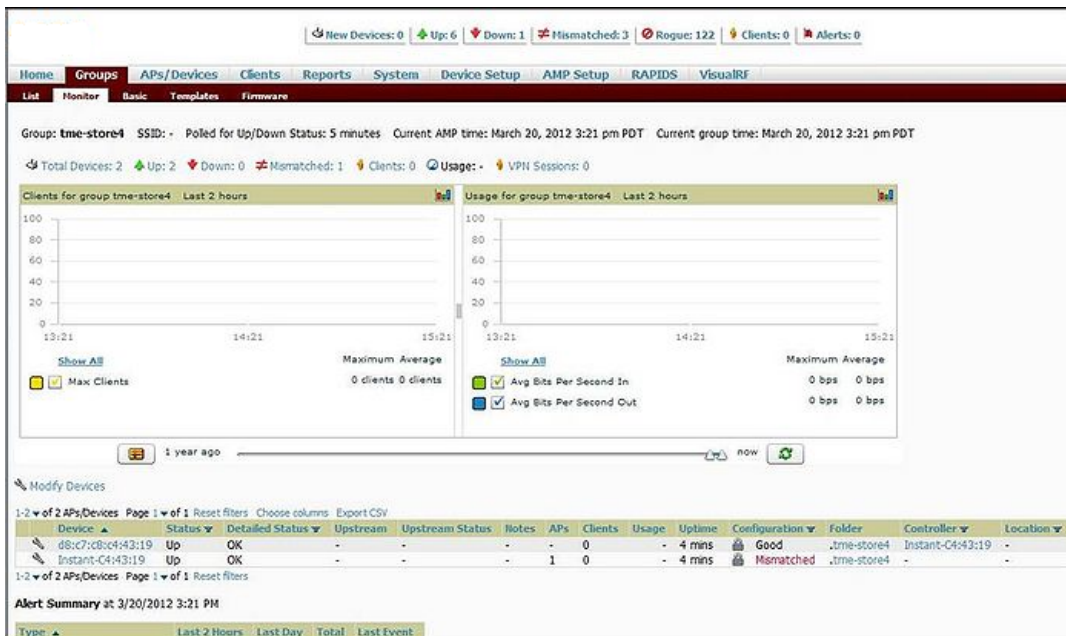

Figure 31 *OmniVista 3600 Air Manager—Monitor*



For more information on provisioning, managing, and monitoring the OAW-IAPs from OmniVista 3600 Air Manager, refer to the *OmniVista 3600 Air Manager Alcatel-Lucent AOS-W Instant Deployment Guide*.

WebSocket Connection

WebSocket is a protocol based on which the virtual switches and the slave OAW-IAPs can establish and maintain a connection with the OmniVista 3600 Air Manager server. A WebSocket support is more efficient because the server does not depend on a client request to respond to an OAW-IAP. When a WebSocket connection is established, all the access points including virtual switches and slaves can communicate with the server at any time. Virtual switches can communicate with the OmniVista 3600 Air Manager management server. Slave OAW-IAPs can communicate with application level components.

A new WebSocket capable OAW-IAP connects to a server through the HTTPS post. If a server supports WebSocket, it will send an HTTP redirect message to the OAW-IAP. The OAW-IAP closes the existing HTTPS connection and connects to the server through WebSocket. If the server does not support WebSocket, it will ignore the header and OAW-IAPs will continue using HTTPS and XML to communicate with the server.

In the CLI

To view the websocket status between OAW-IAPs and OmniVista 3600 Air Manager:

```
(Instant AP)# show ap debug airwave
```

This chapter provides the following information:

- [Uplink Interfaces on page 424](#)
- [Uplink Preferences and Switching on page 430](#)

Uplink Interfaces

AOS-W Instant network supports Ethernet, 3G and 4G USB modems, and the Wi-Fi uplink to provide access to the corporate AOS-W Instant network. The 3G/4G USB modems and the Wi-Fi uplink can be used to extend the connectivity to places where an Ethernet uplink cannot be configured. It also provides a reliable backup link for the Ethernet-based AOS-W Instant network.

The following figure illustrates a scenario in which the OAW-IAPs join the virtual switch as slave OAW-IAPs through a wired or mesh Wi-Fi uplink:

Figure 32 *Uplink Types*

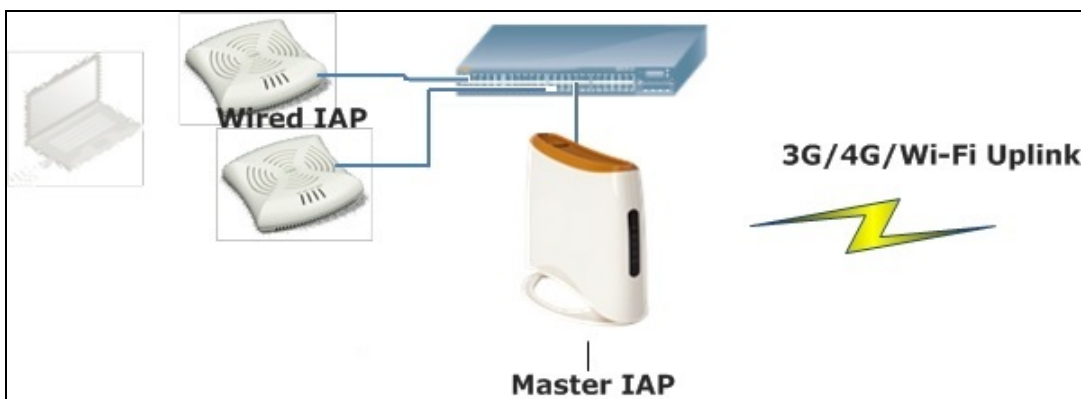

The following types of uplinks are supported on AOS-W Instant:

- [Ethernet Uplink](#)
- [Cellular Uplink](#)
- [Wi-Fi Uplink](#)

Ethernet Uplink

The Eth0 port on an OAW-IAP is enabled as an uplink port by default. You can view the type of uplink and the status of uplink of an OAW-IAP in the **Info** tab on selecting a client.

Ethernet uplink supports the following types of configuration:

- PPPoE
- DHCP
- Static IP

You can use PPPoE for your uplink connectivity in both OAW-IAP and IAP-VPN deployments. PPPoE is supported only in a single OAW-IAP deployment.



Uplink redundancy with the PPPoE link is not supported.

When the Ethernet link is up, it is used as a PPPoE or DHCP uplink. After the PPPoE settings are configured, PPPoE has the highest priority for the uplink connections. The OAW-IAP can establish a PPPoE session with a PPPoE server at the ISP and get authenticated using PAP or CHAP. Depending upon the request from the PPPoE server, either the PAP or the CHAP credentials are used for authentication. After configuring PPPoE, reboot the OAW-IAP for the configuration to take effect. The PPPoE connection is dialed after the OAW-IAP comes up. The PPPoE configuration is checked during OAW-IAP boot and if the configuration is correct, Ethernet is used for the uplink connection.



When PPPoE is used, do not configure Dynamic RADIUS Proxy and IP address of the virtual switch. An SSID created with default VLAN is not supported with PPPoE uplink.

You can also configure an alternate Ethernet uplink to enable uplink failover when an Ethernet port fails.

Configuring PPPoE Uplink Profile

You can configure PPPoE settings from the WebUI or the CLI.

In the Old WebUI

Configuring PPPoE settings:

1. Click the **System** link on the AOS-W Instant main window.
2. Click the **Show advanced options** link.
3. Go to the **Uplink** tab.
4. Perform the following steps in the **PPPoE** section:
 - a. Enter the PPPoE service name provided by your service provider in the **Service name** text box.
 - b. Enter the secret key used for CHAP authentication in the **CHAP secret** and **Retype** text boxes. You can use a maximum of 34 characters for the CHAP secret key.
 - c. Enter the username for the PPPoE connection in the **User** text box.
 - d. Enter a password for the PPPoE connection and confirm the password in the **Password** and **Retype** text boxes.
5. Select a value from the **Local interface** drop-down list to set a local interface for the PPPoE uplink connections. The selected DHCP scope will be used as a local interface on the PPPoE interface and the Local L3 DHCP gateway IP address as its local IP address. When configured, the local interface acts as an unnumbered PPPoE interface and allows the entire Local L3 DHCP subnet to be allocated to clients.



The options in the **Local interface** drop-down list are displayed only if a Local L3 DHCP scope is configured on the OAW-IAP.

6. Click **OK**.
7. Reboot the OAW-IAP for the configuration to take effect.

In the New WebUI

Configuring PPPoE settings:

1. Go to **Configuration > System > Show advanced options**.
2. Expand **Uplink**.
3. Under **PPPoE** perform the following steps:
 - a. Enter the PPPoE service name provided by your service provider in the **Service name** text box.

- b. Enter the username for the PPPoE connection in the **User** text box.
 - c. Enter the secret key used for CHAP authentication in the **CHAP secret** and **Retype** text boxes. You can use a maximum of 34 characters for the CHAP secret key.
 - d. Enter a password for the PPPoE connection and confirm the password in the **Password** and **Retype** text boxes.
4. Select a value from the **Local interface** drop-down list to set a local interface for the PPPoE uplink connections. The selected DHCP scope will be used as a local interface on the PPPoE interface and the Local L3 DHCP gateway IP address as its local IP address. When configured, the local interface acts as an unnumbered PPPoE interface and allows the entire Local L3 DHCP subnet to be allocated to clients.



The options in the **Local interface** drop-down list are displayed only if a Local L3 DHCP scope is configured on the OAW-IAP.

5. Click **Save**.
6. Reboot the OAW-IAP for the configuration to take effect.

In the CLI

To configure a PPPoE uplink connection:

```
(Instant AP) (config) # pppoe-uplink-profile
(Instant AP) (pppoe-uplink-profile)# pppoe-svcname <service-name>
(Instant AP) (pppoe-uplink-profile)# pppoe-username <username>
(Instant AP) (pppoe-uplink-profile)# pppoe-passwd <password>
(Instant AP) (pppoe-uplink-profile)# pppoe-chapsecret <password>
(Instant AP) (pppoe-uplink-profile)# pppoe-unnumbered-local-l3-dhcp-profile <dhcp-profile>
```

To view the PPPoE configuration:

```
(Instant AP) # show pppoe config
```

```
PPPoE Configuration
```

```
-----
```

Type	Value
User	testUser
Password	3c28ec1b82d3eef0e65371da2f39c4d49803e5b2bc88be0c
Service name	internet03
CHAP secret	8e87644deda9364100719e017f88ebce
Unnumbered dhcp profile	dhcpProfile1

To view the PPPoE status:

```
(Instant AP) # show pppoe status
```

```
pppoe uplink state:Suppressed.
```

Cellular Uplink

AOS-W Instant supports the use of 3G and 4G USB modems to provide the Internet backhaul to an AOS-W Instant network. The 3G or 4G USB modems can be used to extend client connectivity to places where an Ethernet uplink cannot be configured. This enables the OAW-IAPs to automatically choose the available network in a specific region.



OAW-RAP155/155P devices do not support the high-speed option module.



When UML290 runs in auto-detect mode, the modem can switch from 4G network to 3G network or vice-versa based on the signal strength. To configure the UML290 for the 3G network only, manually set the USB type to **pantech-3g**. To configure the UML290 for the 4G network only, manually set the 4G USB type to **pantech-lte**.

Configuring Cellular Uplink Profiles

You can configure 3G or 4G uplinks by using the WebUI or the CLI.

In the Old WebUI

To configure 3G/4G uplinks:

1. Click the **System** link on the AOS-W Instant main window.
2. Click the **show advanced settings** link.
3. Click the **Uplink** tab.
4. In the **3G/4G** section, select the options from the **Country** and **ISP** drop-down lists, as required.
5. Click **OK**.
6. Reboot the OAW-IAP for changes to take effect.

In the New WebUI

To configure 3G/4G uplinks:

1. Go to **Configuration > System > show advanced settings**.
2. Expand **Uplink**.
3. In the **3G/4G** section, select the options from the **Country** and **ISP** drop-down lists, as required.
4. Click **Save**.
5. Reboot the OAW-IAP for changes to take effect.

In the CLI

To configure 3G/4G uplink manually:

```
(Instant AP) (config) # cellular-uplink-profile
(Instant AP) (cellular-uplink-profile) # usb-type <3G-usb-type>
(Instant AP) (cellular-uplink-profile) # 4g-usb-type <4g-usb>
(Instant AP) (cellular-uplink-profile) # modem-country <country>
(Instant AP) (cellular-uplink-profile) # modem-isp <service-provider-name>
(Instant AP) (cellular-uplink-profile) # usb-auth-type <usb-authentication_type>
(Instant AP) (cellular-uplink-profile) # usb-user <username>
(Instant AP) (cellular-uplink-profile) # usb-passwd <password>
(Instant AP) (cellular-uplink-profile) # usb-dev <device-ID>
(Instant AP) (cellular-uplink-profile) # usb-tty <tty-port>
(Instant AP) (cellular-uplink-profile) # usb-init <Initialization-parameter>
(Instant AP) (cellular-uplink-profile) # usb-dial <dial-parameter>
(Instant AP) (cellular-uplink-profile) # usb-modeswitch <usb-modem>
```

To switch a modem from the storage mode to modem mode:

```
(Instant AP) (cellular-uplink-profile) # usb-modeswitch <usb-modem>
```

To view the cellular configuration:

```
(Instant AP) # show cellular config
```

Managing Cellular SIM PIN

OAW-IAPs now support the SIM PIN management functions such as locking, unlocking, and renewing the SIM PIN of the 3G/4G modems. In the current release, these functions can be configured only through the OAW-IAP CLI.

To prevent any fraudulent use of 3G/4G modems connected to an OAW-IAP, you can enable locking of the SIM PIN of the modems. When enabled, if an incorrect PIN code is provided in the three consecutive attempts, the SIM PIN is locked. To unlock the PIN, the users must use the Personal Unblocking Code code provided by your ISP.



After enabling SIM PIN lock, reboot the OAW-IAP to apply the SIM PIN lock configuration changes.

To enable SIM PIN lock:

```
(Instant AP)# pin-enable <pin_current_used>
```

To disable SIM PIN locking:

```
(Instant AP)# no pin-enable <pin_current_used>
```

To unlock a PIN with the PUK code provided by the operator:

```
(Instant AP)# pin-puk <pin_puk> <pin_new>
```

To renew the PIN:

```
(Instant AP)# pin-renew <pin_current> <pin_new>
```

Cellular Uplink Preemption

AOS-W Instant 8.4.0.0 introduces a preemption enhancement method for IAP-VPN wherein OAW-IAPs can detect the reachability of a primary VPN over the Ethernet uplink by simultaneously keeping the secondary 3G/4G uplink stable.

Users can set two Internet failover IP addresses; one for Ethernet uplink and another for cellular 3G/4G uplink. When the cellular uplink IP address is not set, it takes the IP address of the Ethernet uplink.

When the current uplink is Ethernet, the Internet failover IP address is used to detect Internet reachability of Ethernet. When the current uplink is cellular, the cellular Internet failover IP address is used to detect Internet reachability of cellular 3G/4G. In the background, the Internet failover IP address detects Internet reachability of Ethernet and determines whether or not a preemption must take place.

You can configure the Internet failover IP address for a cellular 3G/4G uplink by using the CLI:

In the CLI

```
(Instant AP)(config)# uplink
(Instant AP)(uplink)# failover-internet-ip-for-cellular-uplink
```

Wi-Fi Uplink

The Wi-Fi uplink is supported on all the OAW-IAP models, except for the 802.11ac OAW-IAP models (OAW-IAP-2xx and OAW-IAP-3xx Series access points). However only the master OAW-IAP uses this uplink. The Wi-Fi allows uplink to open, PSK-CCMP, and PSK-TKIP SSIDs.

- For single-radio OAW-IAPs, the radio serves wireless clients and the Wi-Fi uplink.
- For dual-radio OAW-IAPs, both radios can be used to serve clients but only one of them can be used for the Wi-Fi uplink.



When the Wi-Fi uplink is in use, the client IP is assigned by the internal DHCP server.

Configuring a Wi-Fi Uplink Profile

The following configuration conditions apply to the Wi-Fi uplink:

- To bind or unbind the Wi-Fi uplink on the 5 GHz band, reboot the OAW-IAP.
- If the Wi-Fi uplink is used on the 5 GHz band, mesh is disabled. The two links are mutually exclusive.
- For OAW-IAPs to connect to an AOS-W Instant-based WLAN using Wi-Fi uplink, the switch must run AOS-W Instant 6.2.1.0 or later.

In the Old WebUI

To provision an OAW-IAP with the Wi-Fi uplink:

1. If you are configuring a Wi-Fi uplink after restoring factory settings on an OAW-IAP, connect the OAW-IAP to an Ethernet cable to allow the OAW-IAP to get the IP address. Otherwise, go to step 2.
2. Click the **System** link on the AOS-W Instant main window.
3. Click the **Show advanced options** link. The advanced options are displayed.
4. Click the **Uplink** tab.
5. Under **Wi-Fi**, enter the name of the wireless network that is used for the Wi-Fi uplink in the **Name (SSID)** text box.
6. Select the type of key for uplink encryption and authentication from the **Key management** drop-down list. If the uplink wireless router uses mixed encryption, WPA-2 is recommended for the Wi-Fi uplink.
7. Select the band in which the virtual switch currently operates, from the **Band** drop-down list. The following options are available:
 - 2.4 GHz (default)
 - 5 GHz
8. Select a passphrase format from the **Passphrase format** drop-down list. The following options are available:
 - 8–63 alphanumeric characters
 - 64 hexadecimal characters



Ensure that the hexadecimal password string is exactly 64 digits in length.

9. Enter a PSK passphrase in the **Passphrase** text box and click **OK**.
10. Navigate to **System > General > Show advanced options** and set the **Extended SSID** parameter to **Disabled**.
11. Click **OK**.
12. Reboot the OAW-IAP to apply the changes. After the OAW-IAP reboots, the Wi-Fi and mesh links are automatically enabled.

In the New WebUI

To provision an OAW-IAP with the Wi-Fi uplink:

1. If you are configuring a Wi-Fi uplink after restoring factory settings on an OAW-IAP, connect the OAW-IAP to an Ethernet cable to allow the OAW-IAP to get the IP address. Otherwise, go to step 2.
2. Go to **Configuration > System > Show advanced options**.
3. Expand **Uplink**.
4. In the **Wifi** section, enter the name of the wireless network that is used for the Wi-Fi uplink in the **Name (SSID)** text box.
5. Select the type of key for uplink encryption and authentication from the **Key management** drop-down list. If the uplink wireless router uses mixed encryption, WPA-2 is recommended for the Wi-Fi uplink.
6. Select the band in which the virtual switch currently operates, from the **Band** drop-down list. The following options are available:
 - 2.4 GHz (default)
 - 5 GHz

7. Select a passphrase format from the **Passphrase format** drop-down list. The following options are available:

- 8–63 alphanumeric characters
- 64 hexadecimal characters



Ensure that the hexadecimal password string is exactly 64 digits in length.

8. Enter a PSK passphrase in the **Passphrase** text box and click **Save**.

9. Navigate to **System > General > Show advanced options** and disable the **Extended SSID** toggle switch.

10. Click **Save**.

11. Reboot the OAW-IAP to apply the changes. After the OAW-IAP reboots, the Wi-Fi and mesh links are automatically enabled.

In the CLI

To configure Wi-Fi uplink on an OAW-IAP:

```
(Instant AP) (config) # wlan sta-profile
(Instant AP) (sta uplink)# cipher-suite<clear | wpa-tkip-psk | wpa2-ccmp-psk>
(Instant AP) (sta uplink)# essid <ssid>
(Instant AP) (sta uplink)# uplink-band <band>
(Instant AP) (sta uplink)# wpa-passphrase <key>
```

To view the W-Fi uplink status in the CLI:

```
(Instant AP)# show wifi-uplink status
configured      :NO
```

To view the configuration status in the CLI:

```
(Instant AP)# show wifi-uplink config
```

```
ESSID           :
Cipher Suite    :
Passphrase      :
Band            :
```

```
(Instant AP)# show wifi-uplink auth log
```

```
-----
wifi uplink auth configuration:
-----
```

```
wifi uplink auth log:
-----
```

```
[1116]2000-01-01 00:00:45.625: Global control interface '/tmp/supp_gbl'
```

Uplink Preferences and Switching

This topic describes the following procedures:

- [Enforcing Uplinks on page 431](#)
- [Setting an Uplink Priority on page 431](#)
- [Enabling Uplink Preemption on page 432](#)
- [Switching Uplinks Based on VPN and Internet Availability on page 433](#)
- [Viewing Uplink Status and Configuration on page 435](#)

Enforcing Uplinks

The following configuration conditions apply to the uplink enforcement:

- When an uplink is enforced, the OAW-IAP uses the specified uplink as the primary uplink regardless of uplink preemption configuration and the current uplink status.
- When an uplink is enforced and multiple Ethernet ports are configured, and if the uplink is enabled on the wired profiles, the OAW-IAP tries to find an alternate Ethernet link based on the priority configured.
- When no uplink is enforced and preemption is not enabled, and if the current uplink fails, the OAW-IAP tries to find an available uplink based on the priority configured. The uplink with the highest priority is used as the primary uplink. For example, if Wi-Fi-sta has the highest priority, it is used as the primary uplink.
- When no uplink is enforced and preemption is enabled, and if the current uplink fails, the OAW-IAP tries to find an available uplink based on the priority configured. If current uplink is active, the OAW-IAP periodically tries to use a higher-priority uplink and switches to the higher-priority uplink even if the current uplink is active.

You can enforce a specific uplink on an OAW-IAP by using the WebUI or the CLI.

In the Old WebUI

To enforce an uplink:

1. Go to **System > Show advanced options > Uplink**.
2. Under **Management**, select the type of uplink from the **Enforce uplink** drop-down list. If the Ethernet uplink is selected, the **Port** text box is displayed.
3. Specify the Ethernet interface port number.
4. Click **OK**. The selected uplink is enforced on the OAW-IAP.

In the New WebUI

To enforce an uplink:

1. Go to **Configuration > System > Show advanced options**.
2. Expand **Uplink**.
3. Under **Management**, select the type of uplink from the **Enforce uplink** drop-down list. If **Ethernet uplink** is selected, the **Port** text box is displayed.
4. Specify the Ethernet interface port number.
5. Click **Save**. The selected uplink is enforced on the OAW-IAP.

In the CLI

To enforce an uplink:

```
(Instant AP) (config)# uplink
(Instant AP) (uplink)# enforce {cellular|ethernet | wifi | none}
```

Setting an Uplink Priority

You can set an uplink priority by using the WebUI or the CLI.

In the Old WebUI

Setting an uplink priority:

1. Go to **System > Show advanced options > Uplink**.
2. In the **Uplink Priority List** window, select the uplink, and click the **up** arrow or the **down** arrow icons to increase or decrease the priority. By default, the **Eth0** uplink is set as a high-priority uplink.
3. Click **OK**. The selected uplink is prioritized over other uplinks.

In the New WebUI

Setting an uplink priority:

1. Go to **Configuration > System > Show advanced options**.
2. Expand **Uplink**.
3. In the **Uplink Priority List** window, select the uplink, and click the **up** arrow or the **down** arrow icons to increase or decrease the priority. By default, the **eth0** uplink is set as a high-priority uplink.
4. Click **Save**. The selected uplink is prioritized over other uplinks.

In the CLI

Setting an uplink priority:

```
(Instant AP) (config)# uplink
(Instant AP) (uplink)# uplink-priority {cellular <priority> | ethernet <priority> | [port
<Interface-number> <priority>] | wifi <priority>}
```

Setting an Ethernet uplink priority :

```
(Instant AP) (uplink)# uplink-priority ethernet port 0 1
```

Enabling Uplink Preemption

The following configuration conditions apply to uplink preemption:

- Preemption can be enabled only when no uplink is enforced.
- When preemption is disabled and the current uplink goes down, the OAW-IAP tries to find an available uplink based on the uplink priority configuration.
- When preemption is enabled and if the current uplink is active, the OAW-IAP periodically tries to use a higher-priority uplink, and switches to a higher-priority uplink even if the current uplink is active.

You can enable uplink preemption by using WebUI or the CLI.

In the Old WebUI

To enable uplink preemption:

1. Go to **System > Show advanced options > Uplink**.
2. Under **Management**, ensure that **Enforce uplink** is set to **None**.
3. Select **Enabled** from the **Pre-emption** drop-down list.
4. Click **OK**.

In the New WebUI

To enable uplink preemption:

1. Go to **Configuration > System > Show advanced options**.
2. Expand **Uplink**.
3. Under **Management**, ensure that **Enforce uplink** is set to **None**.
4. Toggle the **Pre-emption** switch to enable.
5. Click **Save**.

In the CLI

To configure uplink preemption:

```
(Instant AP) (config)# uplink
(Instant AP) (uplink)# preemption
```

Switching Uplinks Based on VPN and Internet Availability

The default priority for uplink switchover is Ethernet and then 3G/4G. The OAW-IAP can switch to the lower-priority uplink if the current uplink is down.

Switching Uplinks Based on VPN Status

AOS-W Instant supports switching uplinks based on the VPN status when deploying multiple uplinks (Ethernet, 3G/4G, and Wi-Fi). When VPN is used with multiple backhaul options, the OAW-IAP switches to an uplink connection based on the VPN connection status, instead of only using the Ethernet or the physical backhaul link.

The following configuration conditions apply to uplink switching:

- If the current uplink is Ethernet and the VPN connection is down, the OAW-IAP tries to reconnect to VPN. The retry time depends on the fast failover configuration and the primary or backup VPN tunnel. If this fails, the OAW-IAP waits for the VPN failover timeout and selects a different uplink such as 3G/4G or Wi-Fi.
- If the current uplink is 3G or Wi-Fi, and Ethernet has a physical link, the OAW-IAP periodically suspends user traffic to try and connect to the VPN on the Ethernet. If the OAW-IAP succeeds, the OAW-IAP switches to Ethernet. If the OAW-IAP does not succeed, it restores the VPN connection to the current uplink.

Uplink switching based on VPN status is automatically enabled if VPN is configured on the OAW-IAP. However, you can specify the duration in the **VPN failover timeout** text box of the old WebUI or the new WebUI to wait for an uplink switch. By default, this duration is set to **180** seconds. The OAW-IAP monitors the VPN status and when the VPN connection is not available for 3 minutes, the uplink switches to another available connection (if a low-priority uplink is detected and the uplink preference is set to none). When **VPN failover timeout** is set to **0** in the old WebUI or the new WebUI, the uplink does not switch over.

When uplink switching based on the Internet availability is enabled, the uplink switching based on VPN failover is automatically disabled.

Switching Uplinks Based on Internet Availability

You can configure AOS-W Instant to switch uplinks based on Internet availability.

When the uplink switchover based on Internet availability is enabled, the OAW-IAP continuously sends Internet Control Management Protocol packets to some well-known Internet servers. If the request is timed out due to a bad uplink connection or uplink interface failure, and the public Internet is not reachable from the current uplink, the OAW-IAP switches to a different connection.

You can set preferences for uplink switching by using the WebUI and the CLI.

In the Old WebUI

To configure uplink switching:

1. Go to **System > Show advanced options > Uplink**.
2. Under **Management**, configure the following parameters:
 - **VPN failover timeout**—To configure uplink switching based on VPN status, specify the duration to wait for an uplink switch. The default duration is set to 180 seconds.
 - **Internet failover**—To configure uplink switching based on Internet availability, perform the following steps:
 - a. Select **Enabled** from the **Internet failover** drop-down list.
 - b. Specify the required values for the following parameters:

- **Max allowed test packet loss**—The maximum number of ICMP test packets that are allowed to be lost to determine if the OAW-IAP must switch to a different uplink connection. You can specify a value within the range of 1–1000.
 - **Secs between test packets**—The frequency at which ICMP test packets are sent. You can specify a value within the range of 1–3600 seconds.
 - **Internet check timeout**—Internet check timeout is the duration for the test packet timeout. You can specify a value within the range of 0–3600 seconds and the default value is 10 seconds.
- **Internet failover IP**—To configure an IP address to which the OAW-IAP must send OAW-IAP packets and verify if the Internet is reachable when the uplink is down. By default, the master OAW-IAP sends the ICMP packets to 8.8.8.8 IP address only if the out-of-service operation based on Internet availability (internet-down state) is configured on the SSID.
3. Click **OK**.

In the New WebUI

To configure uplink switching:

1. Go to **Configuration > System > Show advanced options**.
 2. Expand **Uplink**.
 3. Under **Management**, configure the following parameters:
 - **VPN failover timeout**—To configure uplink switching based on VPN status, specify the duration to wait for an uplink switch. The default duration is set to 180 seconds.
 - **Internet failover**—To configure uplink switching based on Internet availability, enable the **Internet failover** toggle switch and perform the following steps:
 - c. Specify the required values for the following parameters:
 - **Max allowed test packet loss**—The maximum number of ICMP test packets that are allowed to be lost to determine if the OAW-IAP must switch to a different uplink connection. You can specify a value within the range of 1–1000.
 - **Secs between test packets**—The frequency at which ICMP test packets are sent. You can specify a value within the range of 1–3600 seconds.
 - **Internet check timeout**—Internet check timeout is the duration for the test packet timeout. You can specify a value within the range of 0–3600 seconds and the default value is 10 seconds.
 - **Internet failover IP**—To configure an IP address to which the OAW-IAP must send OAW-IAP packets and verify if the Internet is reachable when the uplink is down. By default, the master OAW-IAP sends the ICMP packets to 8.8.8.8 IP address only if the out-of-service operation based on Internet availability (internet-down state) is configured on the SSID.
4. Click **Save**.



When **Internet failover** is enabled, the OAW-IAP ignores the VPN status, although uplink switching based on VPN status is enabled.

In the CLI

To enable uplink switching based on VPN status:

```
(Instant AP) (config)# uplink
(Instant AP) (uplink)# failover-vpn-timeout <seconds>
```

To enable uplink switching based on Internet availability:

```

(Instant AP) (config)# uplink
(Instant AP) (uplink)# failover-internet
(Instant AP) (uplink)# failover-internet-ip <ip>
(Instant AP) (uplink)# failover-internet-pkt-lost-cnt <count>
(Instant AP) (uplink)# failover-internet-pkt-send-freq <frequency>

```

Viewing Uplink Status and Configuration

To view the uplink status:

```

(Instant AP)# show uplink status
Uplink preemption           :enable
Uplink preemption interval  :600
Uplink enforce              :none
Ethernet uplink eth0       :DHCP
Uplink Table
-----
Type      State  Priority  In Use
-----  -
eth0      UP     2         Yes
Wifi-sta  INIT   1         No
3G/4G     INIT   3         No
Internet failover          :enable
Internet failover IP      :192.2.0.1
Max allowed test packet loss :10
Secs between test packets  :30
VPN failover timeout (secs) :180
Internet check timeout (secs) :10
ICMP pkt sent              :1
ICMP pkt lost              :1
Continuous pkt lost        :1
VPN down time              :0
AP1X type:NONE
Certification type:NONE
Validate server:NONE

```

To view the uplink configuration in the CLI:

```

(Instant AP)# show uplink config
Uplink preemption           :enable
Uplink preemption interval  :600
Uplink enforce              :none
Ethernet uplink eth0       :DHCP
Internet failover          :disable
Max allowed test packet loss :10
Secs between test packets  :30
VPN failover timeout (secs) :180
Internet check timeout (secs) :10
Secs between test packets  :30

```

The IDS is a feature that monitors the network for the presence of unauthorized OAW-IAPs and clients. It also logs information about the unauthorized OAW-IAPs and clients, and generates reports based on the logged information.

The IDS feature in the AOS-W Instant network enables you to detect rogue OAW-IAPs, interfering OAW-IAPs, and other devices that can potentially disrupt network operations.

This chapter describes the following procedures:

- [Detecting and Classifying Rogue OAW-IAPs on page 436](#)
- [OS Fingerprinting on page 436](#)
- [Configuring WIP and Detection Levels on page 437](#)
- [Configuring IDS on page 443](#)

Detecting and Classifying Rogue OAW-IAPs

A rogue OAW-IAP is an unauthorized OAW-IAP plugged into the wired side of the network.

An interfering OAW-IAP is an OAW-IAP seen in the RF environment but it is not connected to the wired network. While the interfering OAW-IAP can potentially cause RF interference, it is not considered a direct security threat, because it is not connected to the wired network. However, an interfering OAW-IAP may be reclassified as a rogue OAW-IAP.

To detect the rogue OAW-IAPs, go to **More > IDS** in the Old WebUI or go to **Configuration > IDS** in the new WebUI. The built-in IDS scans for access points that are not controlled by the virtual switch. These are listed and classified as either Interfering or Rogue, depending on whether they are on a foreign network or your network.

OS Fingerprinting

The OS Fingerprinting feature gathers information about the client that is connected to the AOS-W Instant network to find the operating system that the client is running on. The following is a list of advantages of this feature:

- Identifying rogue clients—Helps to identify clients that are running on forbidden operating systems.
- Identifying outdated operating systems—Helps to locate outdated and unexpected OS in the company network.
- Locating and patching vulnerable operating systems—Assists in locating and patching specific operating system versions on the network that have known vulnerabilities, thereby securing the company network.

OS Fingerprinting is enabled in the AOS-W Instant network by default. The following operating systems are identified by AOS-W Instant:

- Windows 7
- Windows Vista
- Windows Server
- Windows XP
- Windows ME

- OS-X
- iPhone
- iOS
- Android
- Blackberry
- Linux

Configuring WIP and Detection Levels

WIP offers a wide selection of intrusion detection and protection features to protect the network against wireless threats.

Like most other security-related features of the AOS-W Instant network, the WIP can be configured on the OAW-IAP.

You can configure the following options:

- **Infrastructure Detection Policies**—Specifies the policy for detecting wireless attacks on access points.
- **Client Detection Policies**—Specifies the policy for detecting wireless attacks on clients.
- **Infrastructure Protection Policies**—Specifies the policy for protecting access points from wireless attacks.
- **Client Protection Policies**—Specifies the policy for protecting clients from wireless attacks.
- **Containment Methods**—Prevents unauthorized stations from connecting to your AOS-W Instant network.

Each of these options contains several default levels that enable different sets of policies. An administrator can customize, enable, or disable these options accordingly.

You can configure the detection levels using the WebUI.

In the Old WebUI

1. Go to **More > IDS**. The **Wireless Intrusion Protection (WIP)** window is displayed.
2. In the **Detection > Infrastructure** section, move the slider to a desired level and configure the following levels of detection:
 - High
 - Medium
 - Low
 - Off

The following table describes the detection policies enabled in the Infrastructure Detection **Custom settings** section:

Table 103: *Infrastructure Detection Policies*

Detection Level	Detection Policy
High	<ul style="list-style-type: none"> ■ Detect OAW-IAP Impersonation ■ Detect ad hoc Networks ■ Detect Valid SSID Misuse ■ Detect Wireless Bridge ■ Detect 802.11 40 MHz intolerance settings ■ Detect Active 802.11n Greenfield Mode ■ Detect OAW-IAP Flood Attack ■ Detect Client Flood Attack ■ Detect Bad WEP ■ Detect CTS Rate Anomaly ■ Detect RTS Rate Anomaly ■ Detect Invalid Address Combination ■ Detect Malformed Frame—HT IE ■ Detect Malformed Frame—Association Request ■ Detect Malformed Frame—Auth ■ Detect Overflow IE ■ Detect Overflow EAPOL Key ■ Detect Beacon Wrong Channel ■ Detect devices with invalid MAC OUI
Medium	<ul style="list-style-type: none"> ■ Detect ad hoc networks using VALID SSID—Valid SSID list is autoconfigured based on Instant OAW-IAP configuration ■ Detect Malformed Frame—Large Duration
Low	<ul style="list-style-type: none"> ■ Detect OAW-IAP Spoofing ■ Detect Windows Bridge ■ IDS Signature—Deauthentication Broadcast ■ IDS Signature—Deassociation Broadcast
Off	Rogue Classification

The following table describes the detection policies enabled in the Client Detection **Custom settings** section.

Table 104: *Client Detection Policies*

Detection Level	Detection Policy
High	<ul style="list-style-type: none"> ■ Detect EAP Rate Anomaly ■ Detect Rate Anomaly ■ Detect Chop Chop Attack ■ Detect TKIP Replay Attack ■ IDS Signature—Air Jack ■ IDS Signature—ASLEAP
Medium	<ul style="list-style-type: none"> ■ Detect Disconnect Station Attack ■ Detect Omerta Attack ■ Detect FATA-Jack Attack ■ Detect Block ACK DOS ■ Detect Hotspotter Attack ■ Detect unencrypted Valid Client ■ Detect Power Save DOS Attack
Low	<ul style="list-style-type: none"> ■ Detect Valid Client Misassociation
Off	All detection policies are disabled.

3. Click **Next**.

4. In the **Protection > Infrastructure** section, move the slider to a desired level and configure the following levels of protection:

- High
- Low
- Off

The following table describes the protection policies that are enabled in the Infrastructure Protection **Custom settings** text box:

Table 105: *Infrastructure Protection Policies*

Protection Level	Protection Policy
High	<ul style="list-style-type: none"> ■ Protect from ad hoc Networks ■ Protect OAW-IAP Impersonation
Low	<ul style="list-style-type: none"> ■ Protect SSID—Valid SSID list should be auto-derived from Instant configuration ■ Rogue Containment
Off	All protection policies are disabled

The following table describes the detection policies that are enabled in the Client Protection **Custom settings** text box:

Table 106: *Client Protection Policies*

Protection Level	Protection Policy
High	Protect Windows Bridge
Low	Protect Valid Station
Off	All protection policies are disabled

5. Click **Finish**.

In the New WebUI

1. Navigate to the **Configuration > IDS** page.
2. In the **Detection > Infrastructure** section, move the slider to a desired level and configure the following levels of detection:
 - High
 - Medium
 - Low
 - Off

The following table describes the detection policies enabled in the Infrastructure Detection **Custom settings** section:

Table 107: *Infrastructure Detection Policies*

Detection Level	Detection Policy
High	<ul style="list-style-type: none"> ■ Detect OAW-IAP Impersonation ■ Detect ad hoc Networks ■ Detect Valid SSID Misuse ■ Detect Wireless Bridge ■ Detect 802.11 40 MHz intolerance settings ■ Detect Active 802.11n Greenfield Mode ■ Detect OAW-IAP Flood Attack ■ Detect Client Flood Attack ■ Detect Bad WEP ■ Detect CTS Rate Anomaly ■ Detect RTS Rate Anomaly ■ Detect Invalid Address Combination ■ Detect Malformed Frame—HT IE ■ Detect Malformed Frame—Association Request ■ Detect Malformed Frame—Auth ■ Detect Overflow IE ■ Detect Overflow EAPOL Key ■ Detect Beacon Wrong Channel ■ Detect devices with invalid MAC OUI
Medium	<ul style="list-style-type: none"> ■ Detect ad hoc networks using VALID SSID—Valid SSID list is autoconfigured based on Instant OAW-IAP configuration ■ Detect Malformed Frame—Large Duration
Low	<ul style="list-style-type: none"> ■ Detect OAW-IAP Spoofing ■ Detect Windows Bridge ■ IDS Signature—Deauthentication Broadcast ■ IDS Signature—Deassociation Broadcast
Off	Rogue Classification

The following table describes the detection policies enabled in the Client Detection **Custom settings** section.

Table 108: *Client Detection Policies*

Detection Level	Detection Policy
High	<ul style="list-style-type: none"> ■ Detect EAP Rate Anomaly ■ Detect Rate Anomaly ■ Detect Chop Chop Attack ■ Detect TKIP Replay Attack ■ IDS Signature—Air Jack ■ IDS Signature—ASLEAP
Medium	<ul style="list-style-type: none"> ■ Detect Disconnect Station Attack ■ Detect Omerta Attack ■ Detect FATA-Jack Attack ■ Detect Block ACK DOS ■ Detect Hotspotter Attack ■ Detect unencrypted Valid Client ■ Detect Power Save DOS Attack
Low	<ul style="list-style-type: none"> ■ Detect Valid Client Misassociation
Off	All detection policies are disabled.

3. Click **Save**.

4. In the **Protection > Infrastructure** section, move the slider to a desired level and configure the following levels of protection:

- High
- Low
- Off

The following table describes the protection policies that are enabled in the Infrastructure Protection **Custom settings** text box:

Table 109: *Infrastructure Protection Policies*

Protection Level	Protection Policy
High	<ul style="list-style-type: none"> ■ Protect from ad hoc Networks ■ Protect OAW-IAP Impersonation
Low	<ul style="list-style-type: none"> ■ Protect SSID—Valid SSID list should be auto-derived from Instant configuration ■ Rogue Containment
Off	All protection policies are disabled

The following table describes the detection policies that are enabled in the Client Protection **Custom settings** text box:

Table 110: *Client Protection Policies*

Protection Level	Protection Policy
High	Protect Windows Bridge
Low	Protect Valid Station
Off	All protection policies are disabled

5. Click **Save**.

Containment Methods

You can enable wired and wireless containments to prevent unauthorized stations from connecting to your AOS-W Instant network.

AOS-W Instant supports the following types of containment mechanisms:

- Wired containment—When enabled, OAW-IAPs generate ARP packets on the wired network to contain wireless attacks.
 - wired-containment-ap-adj-mac—Enables a wired containment to Rogue OAW-IAPs whose wired interface MAC address is offset by one from its BSSID.
 - wired-containment-susp-l3-rogue—Enables the users to identify and contain an OAW-IAP with a preset MAC address that is different from the BSSID of the OAW-IAP, if the MAC address that the OAW-IAP provides is offset by one character from its wired MAC address.



Enable the **wired-containment-susp-l3-rogue** parameter only when a specific containment is required, to avoid a false alarm.

- Wireless containment—When enabled, the system attempts to disconnect all clients that are connected or attempting to connect to the identified Access Point.
 - None—Disables all the containment mechanisms.
 - Deauthenticate only—With deauthentication containment, the Access Point or client is contained by disrupting the client association on the wireless interface.
 - Tarpit containment—With Tarpit containment, the Access Point is contained by luring clients that are attempting to associate with it to a tarpit. The tarpit can be on the same channel or a different channel as the Access Point being contained.

Configuring IDS

The IDS policy for OAW-IAPs can be created using the CLI.

To configure IDS using CLI:

```
(Instant AP) (config)# ids
(Instant AP) (IDS)# infrastructure-detection-level <type>
(Instant AP) (IDS)# client-detection-level <type>
(Instant AP) (IDS)# infrastructure-protection-level <type>
(Instant AP) (IDS)# client-protection-level <type>
(Instant AP) (IDS)# wireless-containment <type>
(Instant AP) (IDS)# wired-containment
(Instant AP) (IDS)# wired-containment-ap-adj-mac
```

(Instant AP) (IDS) # wired-containment-susp-l3-rogue
(Instant AP) (IDS) # detect-ap-spoofing
(Instant AP) (IDS) # detect-windows-bridge
(Instant AP) (IDS) # signature-deauth-broadcast
(Instant AP) (IDS) # signature-deassociation-broadcast
(Instant AP) (IDS) # detect-adhoc-using-valid-ssid
(Instant AP) (IDS) # detect-malformed-large-duration
(Instant AP) (IDS) # detect-ap-impersonation
(Instant AP) (IDS) # detect-adhoc-network
(Instant AP) (IDS) # detect-valid-ssid-misuse
(Instant AP) (IDS) # detect-wireless-bridge
(Instant AP) (IDS) # detect-ht-40mhz-intolerance
(Instant AP) (IDS) # detect-ht-greenfield
(Instant AP) (IDS) # detect-ap-flood
(Instant AP) (IDS) # detect-client-flood
(Instant AP) (IDS) # detect-bad-wep
(Instant AP) (IDS) # detect-cts-rate-anomaly
(Instant AP) (IDS) # detect-rts-rate-anomaly
(Instant AP) (IDS) # detect-invalid-addresscombination
(Instant AP) (IDS) # detect-malformed-htie
(Instant AP) (IDS) # detect-malformed-assoc-req
(Instant AP) (IDS) # detect-malformed-frame-auth
(Instant AP) (IDS) # detect-overflow-ie
(Instant AP) (IDS) # detect-overflow-eapol-key
(Instant AP) (IDS) # detect-beacon-wrong-channel
(Instant AP) (IDS) # detect-invalid-mac-oui
(Instant AP) (IDS) # detect-valid-clientmisassociation
(Instant AP) (IDS) # detect-disconnect-sta
(Instant AP) (IDS) # detect-omerta-attack
(Instant AP) (IDS) # detect-fatajack
(Instant AP) (IDS) # detect-block-ack-attack
(Instant AP) (IDS) # detect-hotspotter-attack
(Instant AP) (IDS) # detect-unencrypted-valid
(Instant AP) (IDS) # detect-power-save-dos-attack
(Instant AP) (IDS) # detect-eap-rate-anomaly
(Instant AP) (IDS) # detect-rate-anomalies
(Instant AP) (IDS) # detect-chopchop-attack
(Instant AP) (IDS) # detect-tkip-replay-attack
(Instant AP) (IDS) # signature-airjack
(Instant AP) (IDS) # signature-asleep
(Instant AP) (IDS) # protect-ssid
(Instant AP) (IDS) # rogue-containment
(Instant AP) (IDS) # protect-adhoc-network
(Instant AP) (IDS) # protect-ap-impersonation
(Instant AP) (IDS) # protect-valid-sta
(Instant AP) (IDS) # protect-windows-bridge

This chapter provides the following information:

- [Mesh Network Overview on page 445](#)
- [Setting up AOS-W Instant Mesh Network on page 446](#)
- [Configuring Wired Bridging on Ethernet 0 for Mesh Point on page 447](#)

Mesh Network Overview

The AOS-W Instant secure enterprise mesh solution is an effective way to expand network coverage for outdoor and indoor enterprise environments without any wires. As traffic traverses across mesh OAW-IAPs, the mesh network automatically reconfigures around broken or blocked paths. This self-healing feature provides increased reliability and redundancy and allows the network to continue operation even when an OAW-IAP stops functioning or if a connection fails.

Mesh OAW-IAPs

Mesh network requires at least one valid uplink (wired or 3G) connection. Any provisioned OAW-IAP that has a valid uplink (wired or 3G) functions as a mesh portal, and the OAW-IAP without an Ethernet link functions as a mesh point. The mesh portal can also act as a virtual switch. Mesh portals and mesh points are also known as mesh nodes, a generic term used to describe OAW-IAPs configured for mesh.

If two OAW-IAPs have valid uplink connections, there is redundancy in the mesh network, and most mesh points try to mesh directly with one of the two portals. However, depending on the actual deployment and RF environment, some mesh points may mesh through other intermediate mesh points.

In an AOS-W Instant mesh network, the maximum hop count is two nodes (point > point > portal) and the maximum number of mesh points per mesh portal is eight.

Mesh OAW-IAPs detect the environment when they boot up, locate and associate with their nearest neighbor, to determine the best path to the mesh portal.

AOS-W Instant mesh functionality is supported only on dual-radio OAW-IAPs. On dual-radio OAW-IAPs, the 2.4 GHz radio is always used for client traffic, while the 5 GHz radio is always used for both mesh-backhaul and client traffic.

The mesh network must be provisioned for the first time by plugging into the wired network. After that, the mesh service works on OAW-IAPs like it does on any other regulatory domain.

Mesh Portals

A mesh portal is a gateway between the wireless mesh network and the enterprise wired LAN. The mesh roles are automatically assigned based on the OAW-IAP configuration. A mesh network could have multiple mesh portals to support redundant mesh paths (mesh links between neighboring mesh points that establish the best path to the mesh portal) from the wireless mesh network to the wired LAN.

The mesh portal broadcasts a mesh services set identifier or mesh cluster name to advertise the mesh network service to other mesh points in that AOS-W Instant network. This is not configurable and is transparent to the user. The mesh points authenticate to the mesh portal and establish a link that is secured using AES encryption.



The mesh portal reboots after 5 minutes when it loses its uplink connectivity to a wired network.

Mesh Points

The mesh point establishes an all-wireless path to the mesh portal. The mesh point provides traditional WLAN services such as client connectivity, IDS capabilities, user role association, and QoS for LAN-to-mesh communication to clients and performs mesh backhaul or network connectivity.



A mesh point also supports LAN bridging. You can connect any wired device to the downlink port of the mesh point. In the case of single Ethernet port platforms such as OAW-IAP105, you can convert the Eth0 uplink port to a downlink port by enabling **Eth0 Bridging**. For additional information, see [Configuring Wired Bridging on Ethernet 0 for Mesh Point on page 447](#).

Automatic Mesh Role Assignment

Previously, when a mesh point discovered that the Ethernet 0 port link was up without Ethernet 0 bridge configured, the mesh point rebooted immediately. Alcatel-Lucent AOS-W Instant 8.4.0.0 supports enhanced role detection during OAW-IAP boot up and OAW-IAP running time.

When a mesh point discovers that the Ethernet 0 port link is up, it sends loop detection packets to check whether the Ethernet 0 link is available. If it is available, the mesh point reboots and becomes a mesh portal. Otherwise, the mesh point does not reboot.

Mesh Role Detection During System Boot Up

If an OAW-IAP boots up and discovers that the Ethernet link is down, it acts as a mesh point. If the Ethernet link is up, the OAW-IAP continues to detect if the network is reachable. In a static IP address scenario, the OAW-IAP pings the gateway. If the ping is successful, the OAW-IAP acts as a mesh portal. Otherwise, it acts as a mesh point. In case of DHCP, if the OAW-IAP obtains the IP address successfully, it acts as a mesh portal. Otherwise, it acts as a mesh point. In case of IPv6, OAW-IAPs do not support the static IP address but only support DHCP for detection of network reachability.



If the OAW-IAP has a 3G/4G USB modem plugged, it always acts as a mesh portal.

If the OAW-IAP is set to Ethernet 0 bridging, it always acts as a mesh point.

Mesh Role Detection During System Running Time

- **Mesh Point Role Change:** When a mesh point detects whether its Ethernet link is up, it continues to use Loop Protection (based on the Loop Protection for Secure Jack Port feature), to check if the loop has been detected. If the loop is detected, the OAW-IAP reboots. Otherwise, the OAW-IAP does not reboot and the mesh role continues to act as a mesh point.

You can enable enhanced mesh role detection by using the CLI:

In the CLI

```
(Instant AP) (config)# enhanced-mesh-role-detect
```

Setting up AOS-W Instant Mesh Network

Starting from AOS-W Instant 6.4.0.2-4.1.0.0 release, mesh functionality is disabled by default, because of which over-the-air provisioning of mesh OAW-IAPs is not supported.

To provision OAW-IAPs as mesh OAW-IAPs:

1. Connect the OAW-IAPs to a wired switch.
2. Ensure that the virtual switch key is synchronized and the country code is configured.

3. Ensure that a valid SSID is configured on the OAW-IAP.
4. If the OAW-IAP has a factory default SSID (AOS-W Instant SSID), delete the SSID.
5. If an ESSID is enabled on the virtual switch, disable it and reboot the OAW-IAP cluster.
6. Disconnect the OAW-IAPs that you want to deploy as mesh points from the switch, and place the OAW-IAPs at a remote location. The OAW-IAPs come up without any wired uplink connection and function as mesh points. The OAW-IAPs with valid uplink connections function as mesh portals.



AOS-W Instant does not support the topology in which the OAW-IAPs are connected to the downlink Ethernet port of a mesh point.

Configuring Wired Bridging on Ethernet 0 for Mesh Point

AOS-W Instant supports wired bridging on the Ethernet 0 port of an OAW-IAP. If OAW-IAP is configured to function as a mesh point, you can configure wired bridging.



Enabling wired bridging on this port of an OAW-IAP makes the port available as a downlink wired bridge and allows client access through the port.



When using 3G uplink, the wired port will be used as downlink.

You can configure support for wired bridging on the Ethernet 0 port of an OAW-IAP by using the WebUI or the CLI.

In the Old WebUI

To configure Ethernet bridging:

1. On the **Access Points** tab, select the OAW-IAP to modify.
2. Click the **edit** link.
3. Click the **Uplink** tab.
4. Select **Enable** from the **Eth0 Bridging** drop-down list.
5. Click **OK**.
6. Reboot the OAW-IAP.

In the New WebUI

To configure Ethernet bridging:

1. Go to **Configuration > Access Points** and select the OAW-IAP to modify and click **Edit**.
2. Expand **Uplink**.
3. Toggle the **Eth0 bridging** switch to enable.
4. Click **Save**.
5. Reboot the OAW-IAP.

In the CLI

To configure Ethernet bridging:

```
(Instant AP)# enet0-bridging
```



Make the necessary changes to the wired-profile when eth0 is used as the downlink port. For more information, see [Configuring a Wired Profile on page 134](#).

Mesh Cluster Function

AOS-W Instant 8.4.0.0 introduces the mesh cluster function for easy deployments of OAW-IAPs. Users can configure an ID and a password, and can provision OAW-IAPs to a specific mesh cluster.

In a cluster-based scenario, each network can support multiple mesh profiles. There is no limit to the number of profiles that can be configured. Mesh cluster function is a per-AP setting and must be configured by the user. When an OAW-IAP boots up, it attempts to find a mesh cluster configuration. If the OAW-IAP already has mesh cluster configured, it uses that configuration. Otherwise, it uses the default mesh configuration.

In the default profile, SSID, password, and cluster name are generated by the virtual controller key. OAW-IAPs that belong to the same mesh network can establish mesh links with each other.

In a standalone scenario, OAW-IAPs can establish a mesh link. However, the network role election does not take place. Users can set the same mesh cluster configuration to establish mesh links with other networks. The OAW-IAP operates as a mesh portal or a mesh point based on the uplink.



Mesh role detection remains the same for cluster-based and standalone OAW-IAPs.

You can create mesh cluster configuration in an OAW-IAP by using the CLI.

In the CLI

To configure the key in a mesh cluster:

```
(Instant AP)# mesh-cluster-key <key>
```

To configure the name in a mesh network:

```
(Instant AP)# mesh-cluster-name <name>
```

To disable mesh functionality in a network:

```
(Instant AP)# mesh-disable
```

To view saved mesh configurations, status, and topology:

```
(Instant AP)# show ap mesh cluster {configuration | status | topology}
```

This chapter provides the following information:

- [Layer-3 Mobility Overview on page 449](#)
- [Configuring Layer-3 Mobility on page 450](#)

Layer-3 Mobility Overview

OAW-IAPs form a single AOS-W Instant network when they are in the same Layer-2 domain. As the number of clients increase, multiple subnets are required to avoid broadcast overhead. In such a scenario, a client must be allowed to roam away from the AOS-W Instant network to which it first connected (home network) to another network supporting the same WLAN access parameters (foreign network) and continue its existing sessions.

Layer-3 mobility allows a client to roam without losing its IP address and sessions. If WLAN access parameters are the same across these networks, clients connected to OAW-IAPs in a given AOS-W Instant network can roam to OAW-IAPs in a foreign AOS-W Instant network and continue their existing sessions. Clients roaming across these networks are able to continue using their IP addresses after roaming. You can configure a list of virtual switch IP addresses across which Layer-3 mobility is supported.

The Alcatel-Lucent AOS-W Instant Layer-3 mobility solution defines a Mobility Domain as a set of AOS-W Instant networks, with the same WLAN access parameters, across which client roaming is supported. The AOS-W Instant network to which the client first connects is called its home network. When the client roams to a foreign network, an OAW-IAP in the home network (home OAW-IAP) anchors all traffic to or from this client. The OAW-IAP to which the client is connected in the foreign network (foreign OAW-IAP) tunnels all client traffic to or from the home OAW-IAP through a GRE tunnel.

Figure 33 Routing of traffic when the client is away from its home network

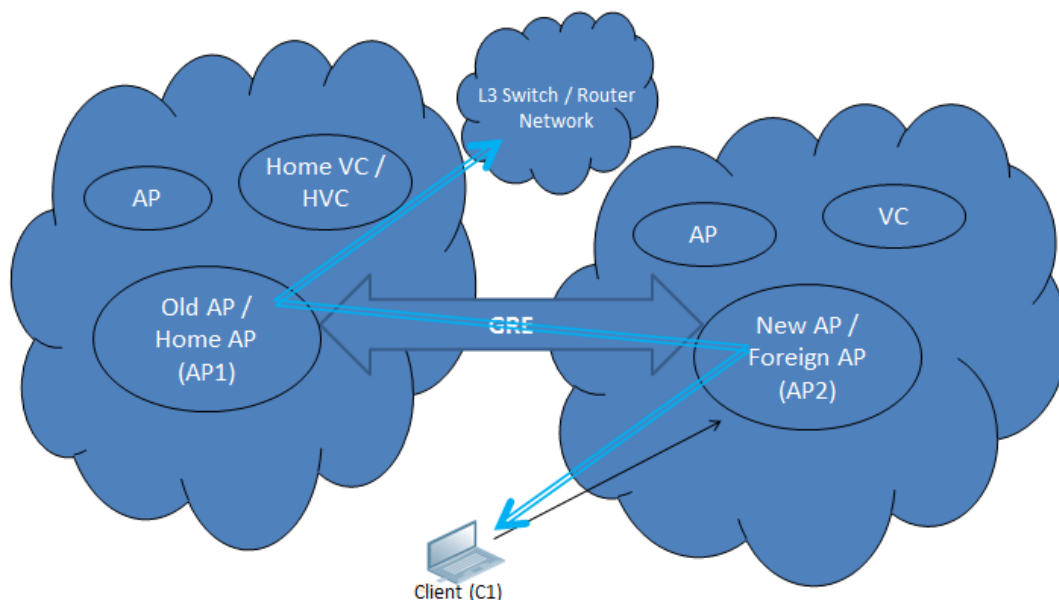

When a client first connects to an AOS-W Instant network, a message is sent to all configured virtual switch IP addresses to see if this is an Layer-3 roamed client. On receiving an acknowledgment from any of the configured virtual switch IP addresses, the client is identified as an Layer-3 roamed client. If the OAW-IAP has no GRE tunnel to this home network, a new tunnel is formed to an OAW-IAP (home OAW-IAP) from the client's home network.

Each foreign OAW-IAP has only one home OAW-IAP per AOS-W Instant network to avoid duplication of broadcast traffic. Separate GRE tunnels are created for each foreign OAW-IAP-home OAW-IAP pair. If a peer OAW-IAP is a foreign OAW-IAP for one client and a home OAW-IAP for another, two separate GRE tunnels are used to handle Layer-3 roaming traffic between these OAW-IAPs.

If client subnet discovery fails on association due to some reason, the foreign OAW-IAP identifies its subnet when it sends out the first Layer-3 packet. If the subnet is not a local subnet and belongs to another AOS-W Instant network, the client is treated as an Layer-3 roamed client and all its traffic is forwarded to the home network through a GRE tunnel.

Configuring Layer-3 Mobility

To configure a mobility domain, you have to specify the list of all AOS-W Instant networks that form the mobility domain. To allow clients to roam seamlessly among all the OAW-IAPs, specify the virtual switch IP for each foreign subnet. You may include the local AOS-W Instant or virtual switch IP address, so that the same configuration can be used across all AOS-W Instant networks in the mobility domain.

It is recommended that you configure all client subnets in the mobility domain.

When the client subnets are configured, note the following scenarios:

- If a client is from a local subnet, it is identified as a local client. When a local client starts using the IP address, Layer-3 roaming is terminated.
- If the client is from a foreign subnet, it is identified as a foreign client. When a foreign client starts using the IP address, Layer-3 roaming is set up.

Home Agent Load Balancing

Home Agent Load Balancing is required in large networks where multiple tunnels might terminate on a single border or lobby OAW-IAP and overload it. When load balancing is enabled, the virtual switch assigns the home OAW-IAP for roamed clients by applying a *round robin* policy. With this policy, the load for the OAW-IAPs acting as Home Agents for roamed clients is uniformly distributed across the OAW-IAP cluster.

Configuring a Mobility Domain for AOS-W Instant

You can configure Layer-3 mobility domain by using the WebUI or the CLI.

In the Old WebUI

To configure a mobility domain:

1. Click the **System** link on the AOS-W Instant main window.
2. Click the **Show advanced options** link.
3. Click the **L3 Mobility** tab.
4. Select **Enabled** from the **Home agent load balancing** drop-down list. By default, home agent load balancing is disabled.
5. Click **New** in the **Virtual Controller IP Addresses** section, add the IP address of a virtual switch that is part of the mobility domain, and click **OK**.
6. Repeat Steps 2 to 5, to add the IP addresses of all virtual switch that form the Layer-3 mobility domain.
7. Click **New** in the **Subnets** section and specify the following:

- a. Enter the client subnet in the **IP address** text box.
 - b. Enter the mask in the **Subnet mask** text box.
 - c. Enter the VLAN ID of the home network in the **VLAN ID** text box.
 - d. Enter the home virtual switch IP address for this subnet in the **Virtual controller IP** text box.
8. Click **OK** in the **New Subnet** window.
 9. Click **OK** in the **L3 Mobility** tab.

In the New WebUI

To configure a mobility domain:

1. Go to the **Configuration > System** page.
2. Click the **Show advanced options**.
3. Expand **L3 Mobility**.
4. Toggle the **Home agent load balancing** switch to enable. By default, home agent load balancing is disabled.
5. Click **+** in the **Virtual Controller IP Addresses** section, add the IP address of a virtual switch that is part of the mobility domain, and click **OK**.
6. Repeat Step 5, to add the IP addresses of all virtual switch that form the Layer-3 mobility domain.
7. Click **+** in the **Subnets** section and specify the following:
 - a. Enter the client subnet in the **IP address** text box.
 - b. Enter the mask in the **Subnet mask** text box.
 - c. Enter the VLAN ID of the home network in the **VLAN ID** text box.
 - d. Enter the home virtual switch IP address for this subnet in the **Virtual controller IP** text box.
8. Click **OK**.
9. Click **Save**.

In the CLI

To configure a mobility domain:

```
(Instant AP) (config)# l3-mobility
(Instant AP) (L3-mobility)# home-agent-load-balancing
(Instant AP) (L3-mobility)# virtual-controller <IP-address>
(Instant AP) (L3-mobility)# subnet <IP-address> <subnet-mask> <VLAN-ID> <virtual-controller-IP-address>
```

This chapter provides the following information:

- [Understanding Spectrum Data on page 452](#)
- [Configuring Spectrum Monitors and Hybrid OAW-IAPs on page 459](#)

Understanding Spectrum Data

Wireless networks operate in environments with electrical and RF devices that can interfere with network communications. Microwave ovens, cordless phones, and even adjacent Wi-Fi networks are all potential sources of continuous or intermittent interference. The spectrum monitor software modules on OAW-IAPs can examine the RF environment in which the Wi-Fi network is operating, identify interference, and classify its sources. An analysis of the results can then be used to quickly isolate issues associated with packet transmission, channel quality, and traffic congestion caused by contention with other devices operating in the same band or channel.

Spectrum monitors are OAW-IAP radios that gather spectrum data but do not service clients. Each SM scans and analyzes the spectrum band used by the SM's radio (2.4 GHz or 5 GHz). An OAW-IAP radio in hybrid OAW-IAP mode continues to serve clients as an access point while it analyzes spectrum analysis data for the channel the radio uses to serve clients. You can record data for both types of spectrum monitor devices. However, the recorded spectrum is not reported to the virtual switch. A spectrum alert is sent to the virtual switch when a non-Wi-Fi interference device is detected.

The spectrum monitor is fully supported on all OAW-IAPs or OAW-RAPs with a few exceptions:

- OAW-RAP155 does not support Spectrum from AOS-W Instant 6.3.1.1-4.0.0.0 release.
- OAW-IAP105 supports the dedicated Spectrum mode, but not the Hybrid Spectrum mode.
- OAW-RAP3 do not support Spectrum display in the WebUI.
- OAW-AP207, OAW-AP203H, and OAW-AP203RP access points do not support Spectrum Monitor.

The spectrum data is collected by each OAW-IAP spectrum monitor and hybrid OAW-IAP. The spectrum data is not reported to the virtual switch. The **Spectrum** link is visible in the WebUI only if you have enabled the Spectrum Monitoring feature.

In the Old WebUI

You can view the following spectrum data:

- [Device List](#)
- [Non-Wi-Fi Interferers](#)
- [Channel Metrics](#)
- [Channel Details](#)
- [Spectrum Alerts](#)

Device List

The device list consists of a device summary table and channel information for active non-Wi-Fi devices currently seen by a spectrum monitor or hybrid OAW-IAP radio. To view the device list, click **Spectrum** in the dashboard.

[Table 111](#) shows the device details that are displayed:

Table 111: *Device Summary and Channel Information*

Column	Description
Type	<p>Device type. This parameter can be any of the following:</p> <ul style="list-style-type: none"> ■ Audio FF (fixed frequency) ■ Bluetooth ■ Cordless base FH (frequency hopper) ■ Cordless phone FF (fixed frequency) ■ Cordless network FH (frequency hopper) ■ Generic FF (fixed frequency) ■ Generic FH (frequency hopper) ■ Generic interferer ■ Microwave ■ Microwave inverter ■ Video ■ Xbox <p>NOTE: For additional details about non-Wi-Fi device types shown in this table, see Non-Wi-Fi Interferer Types.</p>
ID	ID number assigned to the device by the spectrum monitor or hybrid OAW-IAP radio. Spectrum monitors and hybrid OAW-IAPs assign a unique spectrum ID per device type.
Center Frequency (KHz)	Center frequency of the signal sent from the device.
Bandwidth (KHz)	Channel bandwidth used by the device.
Channels-affected	Radio channels affected by the wireless device.
Signal (dBm)	Strength of the signal sent from the device, represented in dBm.
Duty Cycle	Device duty cycle. This value represents the percent of time the device broadcasts a signal.
Add Time	Time at which the device was first detected.
Update Time	Time at which the device's status was updated.

Non-Wi-Fi Interferers

The following table describes each type of non-Wi-Fi interferer detected by the Spectrum Monitor feature:

Table 112: Non-Wi-Fi Interferer Types

Non Wi-Fi Interferer	Description
Bluetooth	Any device that uses the Bluetooth protocol to communicate in the 2.4 GHz band is classified as a <i>Bluetooth</i> device. Bluetooth uses a frequency hopping protocol.
Fixed Frequency (Audio)	Some audio devices such as wireless speakers and microphones also use fixed frequency to continuously transmit audio. These devices are classified as <i>Fixed Frequency (Audio)</i> .
Fixed Frequency (Cordless Phones)	Some cordless phones use a fixed frequency to transmit data (much like the fixed frequency video devices). These devices are classified as <i>Fixed Frequency (Cordless Phones)</i> .
Fixed Frequency (Video)	Video transmitters that continuously transmit video on a single frequency are classified as <i>Fixed Frequency (Video)</i> . These devices typically have close to a 100% duty cycle. These types of devices may be used for video surveillance, TV or other video distribution, and similar applications.
Fixed Frequency (Other)	All other fixed frequency devices that do not fall into any of the above categories are classified as <i>Fixed Frequency (Other)</i> . Note that the RF signatures of the fixed frequency audio, video, and cordless phone devices are very similar and that some of these devices may be occasionally classified as <i>Fixed Frequency (Other)</i> .
Frequency Hopper (Cordless Base)	Frequency hopping cordless phone base units transmit periodic beacon-like frames at all times. When the handsets are not transmitting (that is, when there are no active phone calls), the cordless base is classified as <i>Frequency Hopper (Cordless Base)</i> .
Frequency Hopper (Cordless Network)	When there is an active phone call and one or more handsets are part of the phone conversation, the device is classified as <i>Frequency Hopper (Cordless Network)</i> . Cordless phones may operate in 2.4 GHz or 5 GHz bands. Some phones use both 2.4 GHz and 5 GHz bands (for example, 5 GHz for Base-to-handset and 2.4 GHz for Handset-to-base). These phones may be classified as unique Frequency Hopper devices on both bands.
Frequency Hopper (Xbox)	The Microsoft Xbox device uses a frequency hopping protocol in the 2.4 GHz band. These devices are classified as <i>Frequency Hopper (Xbox)</i> .
Frequency Hopper (Other)	When the classifier detects a frequency hopper that does not fall into any of the prior categories, it is classified as <i>Frequency Hopper (Other)</i> . Some examples include IEEE 802.11 FHSS devices, game consoles, and cordless or hands-free devices that do not use one of the known cordless phone protocols.

Table 112: Non-Wi-Fi Interferer Types

Non Wi-Fi Interferer	Description
Microwave	Common residential microwave ovens with a single magnetron are classified as a <i>Microwave</i> . These types of microwave ovens may be used in cafeterias, break rooms, dormitories, and similar environments. Some industrial, healthcare, or manufacturing environments may also have other equipment that functions like a microwave and may also be classified as a Microwave device.
Microwave (Inverter)	Some newer-model microwave ovens have the inverter technology to control the power output and these microwave ovens may have a duty cycle close to 100%. These microwave ovens are classified as <i>Microwave (Inverter)</i> . Dual-magnetron industrial microwave ovens with higher duty cycle may also be classified as <i>Microwave (Inverter)</i> . There may be other equipment that functions like inverter microwaves in some industrial, healthcare, or manufacturing environments. Those devices may also be classified as <i>Microwave (Inverter)</i> .
Generic Interferer	Any non-frequency hopping device that does not fall into any of the prior categories described in this table is classified as a <i>Generic Interferer</i> . For example, a Microwave-like device that does not operate in the known operating frequencies used by the Microwave ovens may be classified as a <i>Generic Interferer</i> . Similarly wide-band interfering devices may be classified as <i>Generic Interferers</i> .

Channel Details

When you move the mouse over a channel, the channel details or the summary of the 2.4 GHz and 5 GHz channels as detected by a spectrum monitor are displayed. You can view the aggregate data for each channel seen by the spectrum monitor radio, including the maximum OAW-IAP power, interference, and the SNIR. The SNIR is the ratio of signal strength to the combined levels of interference and noise on that channel. Spectrum monitors display spectrum data of all channels in the selected band, and hybrid OAW-IAPs display data for the channel they are monitoring.

[Channel Details Information](#) shows the information that you can view in the Channel Details graph.

Table 113: Channel Details Information

Column	Description
Channel	An 802.11a or 802.11g radio channel.
Quality(%)	Current relative quality of the channel.
Utilization(%)	The percentage of the channel being used.
Wi-Fi (%)	The percentage of the channel currently being used by Wi-Fi devices.
Type	Device type.
Total nonwifi (%)	The percentage of the channel currently being used by non-Wi-Fi devices.
Known OAW-IAPs	Number of valid OAW-IAPs identified on the radio channel.
UnKnown OAW-IAPs	Number of invalid or rogue OAW-IAPs identified on the radio channel.
Channel Util (%)	Percentage of the channel currently in use.

Table 113: Channel Details Information

Column	Description
Max OAW-IAP Signal (dBm)	Signal strength of the OAW-IAP that has the maximum signal strength on a channel.
Max Interference (dBm)	Signal strength of the non-Wi-Fi device that has the highest signal strength.
SNIR (dB)	The ratio of signal strength to the combined levels of interference and noise on that channel. This value is calculated by determining the maximum noise-floor and interference-signal levels, and then calculating how strong the desired signal is above this maximum.

Channel Metrics

The channel metrics graph displays channel quality, availability, and utilization metrics as seen by a spectrum monitor or hybrid OAW-IAP. You can view the channel utilization data based on 2 GHz and 5 GHz radio channels. The percentage of each channel that is currently being used by Wi-Fi devices, and the percentage of each channel being used by non-Wi-Fi devices and 802.11 ACI. The graph shows the channel availability, the percentage of each channel that is available for use, and the current relative quality of selected channels in the 2.4 GHz or 5 GHz radio bands. To view the graphs, click **2.4 GHz** or **5 GHz** in the **Access Point > Spectrum** section of the dashboard. While spectrum monitors can display data for all channels in their selected band, hybrid OAW-IAPs display data for a single monitored channel.

[Channel Metrics](#) shows the information displayed in the **Channel Metrics** graph.

Table 114: Channel Metrics

Column	Description
Channel	A 2.4 GHz or 5 GHz radio channel.
Quality(%)	Current relative quality of selected channels in the 2.4 GHz or 5 GHz radio bands, as determined by the percentage of packet retries, the current noise floor, and the duty cycle for non-Wi-Fi devices on that channel.
Availability(%)	The percentage of the channel currently available for use.
Utilization(%)	The percentage of the channel being used.
WiFi Util(%)	The percentage of the channel currently being used by Wi-Fi devices.
Interference Util (%)	The percentage of the channel currently being used by non-Wi-Fi interference plus Wi-Fi ACI.

Spectrum Alerts

When a new non-Wi-Fi device is found, an alert is reported to the virtual switch. The spectrum alert messages include the device ID, device type, IP address of the spectrum monitor or hybrid OAW-IAP, and the timestamp. The virtual switch reports the detailed device information to AMP.

In the New WebUI

Spectrum data is displayed in the following tabs:

- [Overview](#)
- [2.4 GHz](#)
- [5 GHz](#)

Overview

The following table describes each type of non-Wi-Fi interferer detected by the Spectrum Monitor feature:

Table 115: *Non-Wi-Fi Interferer Types*

Non Wi-Fi Interferer	Description
Type	<p>Device type. This parameter can be any of the following:</p> <ul style="list-style-type: none">■ Audio FF (fixed frequency)■ Bluetooth■ Cordless base FH (frequency hopper)■ Cordless phone FF (fixed frequency)■ Cordless network FH (frequency hopper)■ Generic FF (fixed frequency)■ Generic FH (frequency hopper)■ Generic interferer■ Microwave■ Microwave inverter■ Video■ Xbox <p>NOTE: For additional details about non-Wi-Fi device types shown in this table, see Non-Wi-Fi Interferer Types.</p>
ID	ID number assigned to the device by the spectrum monitor or hybrid OAW-IAP radio. Spectrum monitors and hybrid OAW-IAPs assign a unique spectrum ID per device type.
Center Frequency (KHz)	Center frequency of the signal sent from the device.
Bandwidth (KHz)	Channel bandwidth used by the device.
Channels-Affected	Radio channels affected by the wireless device.
Signal (dBm)	Strength of the signal sent from the device, represented in dBm.
Duty Cycle	Device duty cycle. This value represents the percent of time the device broadcasts a signal.
Add Time	Time at which the device was first detected.
Update Time	Time at which the device's status was updated.

2.4 GHz

The following table describes the utilization and quality of a 2.4 GHz radio channel:

Table 116: 2.4 GHz Metrics

Non Wi-Fi Interferer	Description
Quality(%)	Current relative quality of the channel.
Utilization(%)	The percentage of the channel being used.
WiFi (%)	The percentage of the channel currently being used by Wi-Fi devices.
Bluetooth (%)	Any device that uses the Bluetooth protocol to communicate in the 2.4 GHz band is classified as a <i>Bluetooth</i> device. Bluetooth uses a frequency hopping protocol.
Microwave	Common residential microwave ovens with a single magnetron are classified as a <i>Microwave</i> . These types of microwave ovens may be used in cafeterias, break rooms, dormitories, and similar environments. Some industrial, healthcare, or manufacturing environments may also have other equipment that functions like a microwave and may also be classified as a Microwave device.
Microwave (Inverter)	Some newer-model microwave ovens have the inverter technology to control the power output and these microwave ovens may have a duty cycle close to 100%. These microwave ovens are classified as <i>Microwave (Inverter)</i> . Dual-magnetron industrial microwave ovens with higher duty cycle may also be classified as <i>Microwave (Inverter)</i> . There may be other equipments that function like inverter microwaves in some industrial, healthcare, or manufacturing environments. Those devices may also be classified as <i>Microwave (Inverter)</i> .
Total nonwifi (%)	The percentage of the channel currently being used by non-Wi-Fi devices.
KnownAPs	Number of valid OAW-IAPs identified on the radio channel.
UnKnowAPs	Number of invalid or rogue OAW-IAPs identified on the radio channel.
Noise Floor (dBm)	
MaxAP Signal (dBm)	Signal strength of the OAW-IAP that has the maximum signal strength on a channel.
MaxInterference (dBm)	Signal strength of the non-Wi-Fi device that has the highest signal strength.
SNIR (dB)	The ratio of signal strength to the combined levels of interference and noise on that channel. This value is calculated by determining the maximum noise-floor and interference-signal levels, and then calculating how strong the desired signal is above this maximum.

The **2.4 GHz** tab also shows a statistical view (in %) on radio channel availability, Wi-Fi, interference, and quality.

5 GHz

The following table describes the utilization and quality of a 5 GHz radio channel:

Table 117: 5 GHz Metrics

Non Wi-Fi Interferer	Description
Quality(%)	Current relative quality of the channel.
Utilization(%)	The percentage of the channel being used.
WiFi (%)	The percentage of the channel currently being used by Wi-Fi devices.
Bluetooth (%)	Any device that uses the Bluetooth protocol to communicate in the 5 GHz band is classified as a <i>Bluetooth</i> device. Bluetooth uses a frequency hopping protocol.
Microwave	Common residential microwave ovens with a single magnetron are classified as a <i>Microwave</i> . These types of microwave ovens may be used in cafeterias, break rooms, dormitories, and similar environments. Some industrial, healthcare, or manufacturing environments may also have other equipment that functions like a microwave and may also be classified as a Microwave device.
Microwave (Inverter)	Some newer-model microwave ovens have the inverter technology to control the power output and these microwave ovens may have a duty cycle close to 100%. These microwave ovens are classified as <i>Microwave (Inverter)</i> . Dual-magnetron industrial microwave ovens with higher duty cycle may also be classified as <i>Microwave (Inverter)</i> . There may be other equipments that function like inverter microwaves in some industrial, healthcare, or manufacturing environments. Those devices may also be classified as <i>Microwave (Inverter)</i> .
Total nonwifi (%)	The percentage of the channel currently being used by non-Wi-Fi devices.
KnownAPs	Number of valid OAW-IAPs identified on the radio channel.
UnKnowAPs	Number of invalid or rogue OAW-IAPs identified on the radio channel.
Noise Floor (dBm)	
MaxAP Signal (dBm)	Signal strength of the OAW-IAP that has the maximum signal strength on a channel.
MaxInterference (dBm)	Signal strength of the non-Wi-Fi device that has the highest signal strength.
SNIR (dB)	The ratio of signal strength to the combined levels of interference and noise on that channel. This value is calculated by determining the maximum noise-floor and interference-signal levels, and then calculating how strong the desired signal is above this maximum.

The **5 GHz** tab also shows a statistical view (in %) on radio channel availability, Wi-Fi, interference, and quality.

Configuring Spectrum Monitors and Hybrid OAW-IAPs

An OAW-IAP can be provisioned to function as a spectrum monitor or as a hybrid OAW-IAP. The radios on groups of OAW-IAPs can be converted to dedicated spectrum monitors or hybrid OAW-IAPs through the OAW-IAP group's 802.11a and 802.11g radio profiles.

Converting an OAW-IAP to a Hybrid OAW-IAP

You can convert all OAW-IAPs in an AOS-W Instant network into hybrid OAW-IAPs by selecting the **Background Spectrum Monitoring** option in the 802.11 a and 802.11 g radio profiles of an OAW-IAP. OAW-IAPs in **Access** mode continue to provide normal access service to clients, while providing the additional function of monitoring RF interference. If any OAW-IAP in the AOS-W Instant network does not support the Spectrum Monitoring feature, that OAW-IAP continues to function as a standard OAW-IAP, rather than a hybrid OAW-IAP. By default, the background spectrum monitoring option is disabled.

In the hybrid mode, spectrum monitoring is performed only on the home channel. In other words, if the OAW-IAP-channel width is 80 MHz, spectrum monitoring is performed for 80 MHz. If the channel width is 40, spectrum monitoring is performed for 40 MHz channel. In a dedicated Air Monitor mode, OAW-IAPs perform spectrum monitoring on all channels.

You can convert OAW-IAPs in an AOS-W Instant network to hybrid mode by using the WebUI or the CLI.

In the Old WebUI

To convert an OAW-IAP to a hybrid OAW-IAP:

1. Click the **RF** link on the AOS-W Instant main window.
2. Click **Show advanced options**.
3. Click the **Radio** tab.
4. To enable a spectrum monitor on the 802.11 g radio band of the 2.4 GHz radio profile, select a radio profile in the **2.4 GHz band** section, click **Edit**, and set the **Background spectrum monitoring** parameter to **Enabled**. To create a new 2.4 GHz radio profile, click **New**.
5. To enable a spectrum monitor on the 802.11 a radio band, in the 5 GHz radio profile, select a radio profile in the **5 GHz band** section, click **Edit**, and set the **Background spectrum monitoring** parameter to **Enabled**. To create a new 5 GHz radio profile, click **New**.
6. Click **OK**.
7. Click **OK** in the **Radio** tab.

In the New WebUI

To convert an OAW-IAP to a hybrid OAW-IAP:

1. Navigate to **Configuration > RF** page.
2. Click **Show advanced options**.
3. Expand **Radio**.
4. To enable a spectrum monitor on the 802.11 g radio band of an existing 2.4 GHz radio profile, select a radio profile in the **2.4 GHz band** section, modify the profile as required, and enable the **Background spectrum monitoring** toggle switch. To create a new 2.4 GHz radio profile, click **+**.
5. To enable a spectrum monitor on the 802.11 a radio band of an existing 5 GHz radio profile, select a radio profile in the **5 GHz band** section, modify the profile as required, and enable the **Background spectrum monitoring** toggle switch. To create a new 5 GHz radio profile, click **+**.
6. Click **OK**.
7. Click **Save**.

In the CLI

To configure 2.4 GHz radio settings:

```
(Instant AP) (config)# rf dot11g-radio-profile
(Instant AP) (RF dot11g Radio Profile)# spectrum-monitor
```

To configure 5 GHz radio settings:

```
(Instant AP) (config)# rf dot11a-radio-profile
(Instant AP) (RF dot11a Radio Profile)# spectrum-monitor
```

Converting an OAW-IAP to a Spectrum Monitor

In spectrum mode, spectrum monitoring is performed on entire bands and the OAW-IAP functions as a dedicated full-spectrum RF monitor, scanning all channels to detect interference, whether from the neighboring OAW-IAPs or from non-Wi-Fi devices such as microwaves and cordless phones.

By default, spectrum monitoring is performed on a higher band of the 5 GHz radio.

You can configure an OAW-IAP to function as a stand-alone spectrum monitor by using the WebUI or the CLI.

In the Old WebUI

To convert an OAW-IAP to a spectrum monitor:

1. In the **Access Points** tab, select the OAW-IAP that you want to convert to a spectrum monitor.
2. Click the **edit** link.
3. Click the **Radio** tab.
4. From the **Mode** drop-down list, select **Spectrum Monitor**.
5. Click **OK**.
6. Reboot the OAW-IAP for the changes to take effect.

In the New WebUI

To convert an OAW-IAP to a spectrum monitor:

1. Go to **Configuration > Access Points** and select the OAW-IAP that you want to convert to a spectrum monitor and click **Edit**.
2. Click **Radio**.
3. Select your preferred band and from the **Mode** drop-down list, select **Spectrum Monitor**.
4. Click **Save**.
5. Reboot the OAW-IAP for the changes to take effect.

In the CLI

To convert an OAW-IAP to a spectrum monitor:

```
(Instant AP)# wifi0-mode {<access> | <monitor> | <spectrum-monitor>}
(Instant AP)# wifi1-mode {<access> | <monitor> | <spectrum-monitor>}
```

To enable spectrum monitoring for any other band for the 5 GHz radio:

```
(Instant AP) (config)# rf dot11a-radio-profile
(Instant AP) (RF dot11a Radio Profile)# spectrum-band <type>
```

To view the radio configuration:

```
(Instant AP)# show radio config
2.4 GHz:
Legacy Mode:disable
Beacon Interval:100
802.11d/802.11h:disable
Interference Immunity Level:2
Channel Switch Announcement Count:0
Channel Reuse Type:disable
Channel Reuse Threshold:0
Background Spectrum Monitor:disable

5.0 GHz:
```

Legacy Mode:disable
Beacon Interval:100
802.11d/802.11h:disable
Interference Immunity Level:2
Channel Switch Announcement Count:0
Channel Reuse Type:disable
Channel Reuse Threshold:0
Background Spectrum Monitor:disable
Standalone Spectrum Band:5ghz-upper

This section provides information on the following procedures:

- [Backing up and Restoring OAW-IAP Configuration Data on page 463](#)
- [Converting an OAW-IAP to a OAW-RAP and OAW-AP on page 465](#)
- [Resetting a OAW-RAP or OAW-AP to an OAW-IAP on page 471](#)
- [Rebooting the OAW-IAP on page 471](#)

Backing up and Restoring OAW-IAP Configuration Data

You can back up the OAW-IAP configuration data and restore the configuration when required.

Viewing Current Configuration

To view the current configuration on the OAW-IAP:

- In the old WebUI or the new WebUI, navigate to **Maintenance > Configuration > Current Configuration**.
- In the CLI, enter the following command at the command prompt:

```
(Instant AP)# show running-config
```

Backing up Configuration Data in the Old WebUI

To back up the OAW-IAP configuration data:

1. Navigate to the **Maintenance > Configuration** page.
2. Click **Backup Configuration**.
3. Click **Continue** to confirm the backup. The *instant.cfg* containing the OAW-IAP configuration data will be saved in your local file system.

Backing up Configuration Data in the New WebUI

To back up the OAW-IAP configuration data:

1. Navigate to the **Maintenance > Configuration** page.
2. Click **Backup Configuration**.
3. Click **Continue** to confirm the backup. The *instant.cfg* containing the OAW-IAP configuration data will be saved in your local file system.

To view the configuration that is backed up by the OAW-IAP, enter the following command at the command prompt:

```
(Instant AP)# show backup-config
```

Restoring Configuration in the Old WebUI

To restore configuration:

1. Navigate to the **Maintenance > Configuration** page.
2. Click **Restore Configuration**.
3. Click **Browse** to browse your local system and select the configuration file.
4. Click **Restore Now**.

5. Click **Restore Configuration** to confirm restoration. The configuration is restored and the OAW-IAP reboots to load the new configuration.

Restoring Configuration in the New WebUI

To restore configuration:

1. Navigate to the **Maintenance > Configuration** page.
2. Click **Restore Configuration**.
3. Click **Browse** to browse your local system and select the configuration file.
4. Click **Restore Now**.
5. Click **Restore Configuration** to confirm restoration. The configuration is restored and the OAW-IAP reboots to load the new configuration.

To restore the OAW-IAP configuration, enter the following command at the command prompt:

```
(Instant AP) (config)# copy config tftp://x.x.x.x/configi.cfg
```

Converting an OAW-IAP to a OAW-RAP and OAW-AP

This section provides the following information:

- [Regulatory Domain Restrictions for OAW-IAP to RAP or CAP Conversion on page 465](#)
- [Converting an OAW-IAP to a OAW-RAP on page 467](#)
- [Converting an OAW-IAP to a OAW-AP on page 469](#)
- [Converting an OAW-IAP to Stand-Alone Mode on page 470](#)
- [Converting an OAW-IAP using CLI on page 471](#)

Regulatory Domain Restrictions for OAW-IAP to RAP or CAP Conversion

You can provision an OAW-IAP as a OAW-AP or a OAW-RAP in a switch-based network. Before converting an OAW-IAP, ensure that there is a regulatory domain match between the OAW-IAP and the switch.

The following table describes the regulatory domain restrictions that apply for the OAW-IAP-to-OAW-AP conversion:

Table 118: OAW-IAP-to-AOS-W Conversion

OAW-IAP Variant	OAW-IAP Regulatory Domain	switch Regulatory Domain			AOS-W Instant release
		US	Unrestricted	IS	
<ul style="list-style-type: none"> ■ OAW-IAP207 ■ OAW-IAP304/OAW-IAP305 	US	Y	X	X	AOS-W Instant 6.5.1.0 or later
	RW	X	Y	Y	
	JP	X	Y	X	
<ul style="list-style-type: none"> ■ OAW-IAP314/OAW-IAP315 ■ OAW-IAP334/OAW-IAP335 	US	Y	X	X	AOS-W Instant 6.5.0.0 or later
	RW	X	Y	Y	
	JP	X	Y	X	
<ul style="list-style-type: none"> ■ OAW-IAP324/OAW-IAP325 	US	Y	X	X	AOS-W Instant 6.4.4.0 or later
	RW	X	Y	Y	
	JP	X	Y	X	
<ul style="list-style-type: none"> ■ OAW-IAP277 	US	Y	X	X	AOS-W Instant 6.4.3.0 or later
	RW	X	Y	Y	
	JP	X	Y	X	

Table 118: OAW-IAP-to-AOS-W Conversion

OAW-IAP Variant	OAW-IAP Regulatory Domain	switch Regulatory Domain			AOS-W Instant release
		US	Unrestricted	IS	
■ OAW-IAP228	US	Y	X	X	AOS-W Instant 6.4.3.0 or later
	RW	X	Y	Y	
	JP	X	Y	X	
■ OAW-AP210 Series	US	Y	X	X	AOS-W Instant 6.4.2.0 or later
	RW	X	Y	Y	
	JP	X	Y	X	
	IS	X	X	Y	
■ OAW-IAP274/OAW-IAP275	US	Y	X	X	AOS-W Instant 6.4.0.0 or later
	RW	X	Y	Y	
	JP	X	Y	X	
	IS	X	X	Y	
■ OAW-IAP103H	US	Y	X	X	AOS-W Instant 6.4.0.0 or later
	RW	X	Y	Y	
	JP	X	Y	X	
	IS	X	X	Y	
■ OAW-AP 220 Series	US	Y	X	X	AOS-W Instant 6.3.1.3 or later
	RW	X	Y	Y	
	JP	X	Y	X	
	IS	X	X	Y	
■ OAW-AP110 Series and OAW-AP 220 Series	US	Y	X	X	AOS-W Instant 6.3.1.0, AOS-W Instant 6.3.1.1, and AOS-W Instant 6.3.1.2
	RW	X	X	X	
	JP	X	Y	X	
	IS	X	X	Y	

Table 118: OAW-IAP-to-AOS-W Conversion

OAW-IAP Variant	OAW-IAP Regulatory Domain	switch Regulatory Domain			AOS-W Instant release
		US	Unrestricted	IS	
■ OAW-AP 220 Series	US	Y	X	X	AOS-W Instant 6.3.0.0
	RW/JP/IS	X	X	X	
All other OAW-IAPs	US	Y	X	X	Versions prior to AOS-W Instant 6.3.0.x, AOS-W Instant 6.3.x.x, AOS-W Instant 6.4.0.0, and AOS-W Instant 6.4.x.x
	Unrestricted	X	Y	X	
	IS	X	X	Y	
	JP	X	Y	X	

Converting an OAW-IAP to a OAW-RAP

For converting an OAW-IAP to a Remote AP, the virtual switch sends the OAW-RAP convert command to all the other OAW-IAPs. The virtual switch, along with the slave OAW-IAPs, sets a VPN tunnel to the remote switch, and downloads the firmware through FTP. The virtual switch uses IPsec to communicate to the OmniAccess Mobility Controller over the Internet.

- If the OAW-IAP obtains OmniVista 3600 Air Manager information through DHCP (Option 43 and Option 60), it establishes an HTTPS connection to the OmniVista 3600 Air Manager server, downloads the configuration, and operates in the OAW-IAP mode.
- If the OAW-IAP does not get OmniVista 3600 Air Manager information through DHCP provisioning, it tries provisioning through the Activate server in the cloud by sending a serial number MAC address. If an entry for the OAW-IAP is present in Activate and is provisioned as an OAW-IAP > OAW-RAP, Activate responds with mobility switch IP address, OAW-IAP group, and OAW-IAP type. The OAW-IAP then contacts the switch, establishes certificate-based secure communication, and obtains configuration and image from the switch. The OAW-IAP reboots and comes up as a OAW-RAP. The OAW-IAP then establishes an IPsec connection with the switch and begins operating in the OAW-RAP mode.
- If an OAW-IAP entry is present in Activate and a provisioning rule is configured to return the IP address or host name of the OmniVista 3600 Air Manager server, the OAW-IAP downloads configuration from OmniVista 3600 Air Manager and operates in the OAW-IAP mode.
- If there is no response from Activate, the access point comes up with default configuration and operates in the OAW-IAP mode.



A mesh point cannot be converted to OAW-RAP, because mesh access points do not support VPN connection.

An OAW-IAP can be converted to a OAW-AP and OAW-RAP only if the switch is running AOS-W 6.1.4.0 or later versions:

The following table describes the supported OAW-IAP platforms and minimal AOS-W Instant version required for the OAW-AP or OAW-RAP conversion.

Table 119: OAW-IAP Platforms and Minimum AOS-W Instant Versions for OAW-IAP-to-OAW-RAP Conversion

OAW-IAP Platform	AOS-W Release	AOS-W Instant Release
<ul style="list-style-type: none"> ■ OAW-AP-303P ■ OAW-510 Series ■ OAW-AP-387 	AOS-W 8.4.0.0 or later versions	AOS-W Instant 8.4.0.0 or later versions
<ul style="list-style-type: none"> ■ OAW-AP-344/OAW-AP-345 ■ OAW-AP-374/ OAW-AP-375/OAW-AP-377 ■ OAW-318 Series ■ OAW-303 Series 	AOS-W 8.3.0.0 or later versions	AOS-W Instant 8.3.0.0 or later versions
<ul style="list-style-type: none"> ■ OAW-AP203H 	AOS-W 6.5.3.0 or later versions	AOS-W Instant 6.5.3.0 or later versions
<ul style="list-style-type: none"> ■ OAW-AP203R/OAW-AP203RP ■ OAW-AP303H ■ OAW-AP365/OAW-AP367 	AOS-W 6.5.2.0 or later versions	AOS-W Instant 6.5.2.0 or later versions
<ul style="list-style-type: none"> ■ OAW-IAP304/OAW-IAP305 ■ OAW-IAP207 	AOS-W 6.5.1.0 or later versions	AOS-W Instant 4.3.1.0 or later versions
<ul style="list-style-type: none"> ■ OAW-IAP314/OAW-IAP315 ■ OAW-IAP334/OAW-IAP335 	AOS-W 6.5.0.0 or later versions	AOS-W Instant 4.3.0.0 or later versions
<ul style="list-style-type: none"> ■ OAW-IAP324/OAW-IAP325 	AOS-W 6.4.4.0 or later versions	AOS-W Instant 4.2.2.0 or later versions
<ul style="list-style-type: none"> ■ OAW-IAP228 ■ OAW-IAP277 	AOS-W 6.4.3.1 or later versions	AOS-W Instant 4.2.0.0 or later versions
<ul style="list-style-type: none"> ■ OAW-IAP214/OAW-IAP215 	AOS-W 6.4.2.0 or later versions	AOS-W Instant 4.1.1.0 or later versions
<ul style="list-style-type: none"> ■ OAW-IAP274/OAW-IAP275 	AOS-W 6.4 or later versions	AOS-W Instant 4.1.0.0 or later versions
<ul style="list-style-type: none"> ■ OAW-IAP224/OAW-IAP225 	AOS-W 6.3.1.1 or later versions	AOS-W Instant 4.0.0.0 or later versions
<ul style="list-style-type: none"> ■ OAW-RAP155/OAW-RAP155P 	AOS-W 6.3.0 or later versions	AOS-W Instant 3.3.0.0 or later versions

You can convert an OAW-IAP to a OAW-RAP by using the WebUI.

In the Old WebUI

OAW-IAP to OAW-RAP conversion:

1. Click **Maintenance** in the AOS-W Instant main window.
2. Click the **Convert** tab.
3. Select **Remote APs managed by a Mobility Controller** from the **Convert one or more Access Points to** drop-down list.
4. Enter the host name or the IP address of the switch in the **Hostname or IP Address of Mobility Controller** text box. Contact your local network administrator to obtain the IP address.



Ensure that the OmniAccess Mobility Controller IP address is reachable by the OAW-IAPs.

5. Click **Convert Now** in the **Maintenance** tab.
6. Click **Convert Now** in the **Confirm Access Point Conversion** window. The OAW-IAP reboots and begins operating in the OAW-RAP mode. After conversion, the OAW-IAP is managed by the OmniAccess Mobility Controller.
7. Click **Close**.

In the New WebUI

OAW-IAP to OAW-RAP conversion:

1. Go to the **Maintenance > Convert** page.
2. Select **Remote APs managed by a Mobility Controller** from the **Convert one or more Access Points to** drop-down list.
3. Enter the host name or the IP address of the switch in the **Hostname or IP Address of Mobility Controller** text box. Contact your local network administrator to obtain the IP address.



Ensure that the OmniAccess Mobility Controller IP address is reachable by the OAW-IAPs.

4. Click **Convert** to complete the conversion.
5. Click **OK** to confirm the conversion. The OAW-IAP reboots and begins operating in the OAW-RAP mode. After conversion, the OAW-IAP is managed by the OmniAccess Mobility Controller.



For OAW-IAPs to function as OAW-RAPs, configure the OAW-IAP in the OAW-RAP whitelist and enable the FTP service on the switch.



If the VPN setup fails and an error message is displayed, click **OK**, copy the error logs, and share them with your local administrator.

Converting an OAW-IAP to a OAW-AP

You can convert an OAW-IAP to a OAW-AP by using the WebUI.

In the Old WebUI

OAW-IAP to OAW-AP conversion:

1. Click **Maintenance** in the AOS-W Instant main window.
2. Click the **Convert** tab.
3. Select **Campus APs managed by a Mobility Controller** from the **Convert one or more Access Points to** drop-down list.
4. Enter the host name, FQDN, or the IP address of the switch in the **Hostname or IP Address of Mobility Controller** text box. Contact your local administrator to obtain these details.
5. Click **Convert Now** in the **Maintenance** tab.
6. Click **Convert Now** in the **Confirm Access Point Conversion** window. The OAW-IAP reboots and begins operating in the OAW-AP mode. After conversion, the OAW-IAP is managed by the OmniAccess Mobility Controller.
7. Click **Close**.

In the New WebUI

OAW-IAP to OAW-AP conversion:

1. Go to the **Maintenance > Convert** page.
2. Select **Campus APs managed by a Mobility Controller** from the **Convert one or more Access Points to** drop-down list.
3. Enter the host name, FQDN, or the IP address of the switch in the **Hostname or IP Address of Mobility Controller** text box. Contact your local administrator to obtain these details.
4. Click **Convert** to complete the conversion.
5. Click **OK** to confirm the conversion. The OAW-IAP reboots and begins operating in the OAW-AP mode. After conversion, the OAW-IAP is managed by the OmniAccess Mobility Controller.

ZTP Support for OAW-IAP Conversion

AOS-W Instant 8.4.0.0 enhances ZTP support for automatic conversion of OAW-IAPs to OAW-APs or OAW-RAPs. During or after an OAW-IAP boots up, it periodically sends a provision update request to the Activate server. Activate responds with a provision rule and a switch IP address to deploy the OAW-IAP. Upon receiving a response, the OAW-IAP downloads the image from the switch based on the switch IP address. The OAW-IAP performs the upgrade, erases configurations, and reboots. Now, the OAW-IAP operates as a OAW-AP and finds a switch to connect with. For example, to convert an OAW-IAP to OAW-AP, the provision rule would comprise the CAP mode and the switch IP address.

ZTP supports the following OAW-IAP to OAW-AP scenarios:

OAW-IAP Does Not Save the switch IP Address

An OAW-IAP converts to OAW-AP by talking to switch 1, reboots, performs standard controller discovery, and discovers switch 2. Each time the OAW-AP reboots, it re-performs discovery and does not stick to any switch. The OAW-AP can be moved from network to network without a configuration change.

OAW-IAP Saves the switch IP Address

An OAW-IAP converts to OAW-AP by talking to switch 1, reboots, skips standard switch discovery, and stays with switch 1 permanently. The OAW-AP cannot be moved from network to network without a configuration change.

You can view provision update logs by using the CLI.

In the CLI

To view logs related to provision update with Activate:

```
(Instant AP)# show log provision
```

Converting an OAW-IAP to Stand-Alone Mode

This feature allows you to deploy an OAW-IAP as an autonomous OAW-IAP, which is a separate entity from the existing virtual switch cluster in the Layer 2 domain.

When an OAW-IAP is converted to function in stand-alone mode, it cannot join a cluster of OAW-IAPs even if the OAW-IAP is in the same VLAN. If the OAW-IAP is in the cluster mode, it can form a cluster with other virtual switch OAW-IAPs in the same VLAN.

You can deploy an OAW-IAP as a stand-alone or autonomous OAW-IAP using the WebUI.

In the Old WebUI

OAW-IAP to Stand-Alone Mode:

1. Click **Maintenance** in the AOS-W Instant main window.

2. Click the **Convert** tab.
3. Select **Standalone AP** from the **Convert one or more Access Points to** drop-down list.
4. Select the Access Point from the **Access Point to Convert** drop-down list.
5. Click **Convert Now** to complete the conversion. The OAW-IAP now operates in the stand-alone mode.
6. Click **Close**.

In the New WebUI

OAW-IAP to Stand-Alone Mode:

1. Go to the **Maintenance > Convert** page.
2. Select **Standalone AP** from the **Convert one or more Access Points to** drop-down list.
3. Select the Access Point from the **Access Point to Convert** drop-down list.
4. Click **Convert** to complete the conversion. The OAW-IAP now operates in the stand-alone mode.
5. Click **Close**.

Converting an OAW-IAP using CLI

To convert an OAW-IAP to a OAW-RAP or OAW-AP:

```
(Instant AP)# convert-aos-ap <mode> <controller-IP-address>
```

To convert an OAW-IAP to a stand-alone OAW-IAP or to provision an OAW-IAP in the cluster mode:

```
(Instant AP)# swarm-mode <mode>
```

Resetting a OAW-RAP or OAW-AP to an OAW-IAP

The reset knob located on the rear of an OAW-IAP can be used to reset the OAW-IAP to factory default settings.

To reset an OAW-IAP, perform the following steps:

1. Turn off the OAW-IAP.
2. Press and hold the reset knob using a small and narrow object such as a paperclip.
3. Turn on the OAW-IAP without releasing the reset knob. The power LED flashes within 5 seconds indicating that the reset is completed.
4. Release the reset knob. The OAW-IAP reboots with the factory default settings.

Rebooting the OAW-IAP

If you encounter any problem with the OAW-IAPs, you can reboot all OAW-IAPs or a selected OAW-IAP in a network using the WebUI.

In the Old WebUI

To reboot an OAW-IAP:

1. Click **Maintenance** in the AOS-W Instant main window.
2. Click the **Reboot** tab.
3. In the OAW-IAP list, select the OAW-IAP that you want to reboot and click **Reboot selected Access Point**. To reboot all the OAW-IAPs in the network, click **Reboot All**.
4. The **Confirm Reboot for AP** message is displayed. Click **Reboot Now** to proceed. The **Reboot in Progress** message is displayed indicating that the reboot is in progress. The **Reboot Successful** message is

displayed after the process is complete. If the system fails to boot, the **Unable to contact Access Points after reboot was initiated** message is displayed.

5. Click **OK**.

In the New WebUI

To reboot an OAW-IAP:

1. Go to the **Maintenance > Reboot** page.
2. In the **Select the access point you wish to reboot** drop-down list, select the OAW-IAP that you want to reboot and click **Reboot**. To reboot all the OAW-IAPs in the network, click **Reboot All** from the drop-down list and click **Reboot**.
3. Click **OK** to continue. The **Access Points are rebooting** message is displayed indicating that the reboot is in progress.
4. Click **OK**.

DRT Upgrade

The DRT upgrade feature installs and upgrades the DRT file for an OAW-IAP. When new certifications are available for OAW-IAPs, the subsequent releases will automatically receive support for these certs. Only the newer version of the DRT file is used for an upgrade.



AOS-W Instant supports DRT upgrade from OmniVista 3600 Air Manager, over HTTPs and WebSocket. OAW-IAPs can report the DRT upgrade status to OmniVista 3600 Air Manager and OmniVista 3600 Air Manager can also display the DRT upgrade status to users.

The DRT file is installed under the following scenarios:

OAW-IAP Boot Up

The DRT information is stored at two locations, one in the image file, and another in the flash memory. Every time an OAW-IAP boots up, it compares the DRT version at both the locations and uses the newer version of DRT in the flash.

Install DRT File In a Cluster

When all the OAW-IAPs in a cluster finish downloading the DRT table, the master OAW-IAP communicates to the slave OAW-IAPs to upgrade the DRT file. After the slave OAW-IAPs upgrade the DRT file, the master OAW-IAP proceeds with DRT upgrade. There is a timeout mechanism set during the download and upgrade process. When a slave OAW-IAP has finished DRT downloading from the master OAW-IAP, but has not received an upgrade command within 5 minutes, the slave OAW-IAP will attempt to upgrade the DRT file without waiting. Similarly, if the slave OAW-IAP has not finished downloading within 5 minutes, the master OAW-IAP will not wait for these slaves. It will continue with the rest of the upgrade process.

The DRT version can be upgraded by using the WebUI or CLI.

In the Old WebUI

1. Navigate to the **Maintenance > DRT** page.
2. To upgrade by using a DRT file, select the **DRT file** radio button and click **Browse** to upload the file.
3. To upgrade the DRT by using a web URL, select the **DRT URL** radio button and enter the link in the **URL** text box.
4. Click **Upgrade Now**.

In the New WebUI

1. Navigate to the **Maintenance > Regulatory** page.
2. To manually upgrade an OAW-IAP's DRT version, select the DRT file or update a URL in the **Manual** section.
 - a. If you are using a DRT file, select the **DRT file** radio button, click **Browse**, and then click **Upgrade Now**.
 - b. If you are using a DRT URL, select the **DRT URL** radio button and enter the link in the URL text box.
3. Click **Upgrade Now**.



If a new version of DRT is displayed in the **Automatic** section, upgrade it by clicking **Upgrade Now**.

In the CLI

To upgrade an OAW-IAP cluster with the new DRT version:

```
upgrade-drt <url>
```

To reset the DRT version on an OAW-IAP:

```
reset drt
```

To view the status of DRT version on an OAW-IAP:

```
show drt state
```



AOS-W Instant supports DRT upgrade from OmniVista 3600 Air Manager, over HTTPs and WebSocket. OAW-IAPs can report the DRT upgrade status to OmniVista 3600 Air Manager and OmniVista 3600 Air Manager can also display the DRT upgrade status to users.

This chapter describes the following topics:

- [Configuring SNMP on page 474](#)
- [Configuring a Syslog Server on page 478](#)
- [Configuring TFTP Dump Server on page 480](#)
- [Running Debug Commands on page 481](#)
- [Uplink Bandwidth Monitoring on page 485](#)

Configuring SNMP

This section provides the following information:

- [SNMP Parameters for OAW-IAP on page 474](#)
- [Configuring SNMP on page 475](#)
- [Configuring SNMP Traps on page 477](#)

SNMP Parameters for OAW-IAP

AOS-W Instant supports SNMPv1, SNMPv2, and SNMPv3 for reporting purposes only. An OAW-IAP cannot use SNMP to set values in an Alcatel-Lucent system.

You can configure the following parameters for an OAW-IAP:

Table 120: *SNMP Parameters for OAW-IAP*

Parameter	Description
Community Strings for SNMPV1 and SNMPV2	An SNMP community string is a text string that acts as a password, and is used to authenticate messages sent between the virtual switch and the SNMP agent.
If you are using SNMPv3 to obtain values from the OAW-IAP, you can configure the following parameters:	
Name	A string representing the name of the user.
Authentication Protocol	An indication of whether messages sent on behalf of this user can be authenticated, and if so, the type of authentication protocol used. This can take one of the two values: <ul style="list-style-type: none"> ■ MD5—HMAC-MD5-96 Digest Authentication Protocol ■ SHA—HMAC-SHA-96 Digest Authentication Protocol

Table 120: SNMP Parameters for OAW-IAP

Parameter	Description
Authentication protocol password	If messages sent on behalf of this user can be authenticated, a (private) authentication key is used with the authentication protocol. This is a string password for MD5 or SHA based on the conditions mentioned above.
Privacy protocol	An indication of whether messages sent on behalf of this user can be protected from disclosure, and if so, the type of privacy protocol that is used. This takes the value of CBC-DES symmetric encryption.
Privacy protocol password	If messages sent on behalf of this user can be encrypted or decrypted with DES, the (private) privacy key with the privacy protocol is used.

Configuring SNMP

This section describes the procedure for configuring SNMPv1, SNMPv2, and SNMPv3 community strings by using the WebUI or the CLI.

Creating Community Strings for SNMPv1 and SNMPv2 Using the Old WebUI

To create community strings for SNMPv1 and SNMPv2:

1. Click the **System** link on the AOS-W Instant main window.
2. Click the **Show advanced options** link.
3. Go to the **Monitoring** tab.
4. Click **New** under the **Community Strings for SNMPv1 and SNMPv2** box.
5. Enter the string in the **New Community String** text box and click **OK**.
6. To delete a community string, select the string, and click **Delete**.
7. Click **OK** in the **Monitoring** tab.

Creating Community Strings for SNMPv1 and SNMPv2 Using the New WebUI

To create community strings for SNMPv1 and SNMPv2:

1. Go to **Configuration > System**.
2. Click the **Show advanced options** link.
3. Expand **Monitoring**.
4. Click + under the **Community Strings for SNMPV1 and SNMPV2** box.
5. Enter the string in the **Edit Community String** text box and click **OK**.
6. To delete a community string, select the string and delete.
7. Click **Save**.

Creating Community Strings for SNMPv3 Using the Old WebUI

To create community strings for SNMPv3:

1. Click the **System** link on the AOS-W Instant main window.
2. Click the **Show advanced options** link.
3. Go to the **Monitoring** tab.
4. Click **New** under the **Users for SNMPV3** box. The **New SNMPv3 User** window is displayed.

5. Enter the name of the user in the **Name** text box.
6. Select the type of authentication protocol from the **Auth protocol** drop-down list.
7. Enter the authentication password in the **Password** text box and retype the password in the **Retype** text box.
8. Select the type of privacy protocol from the **Privacy protocol** drop-down list.
9. Enter the privacy protocol password in the **Password** text box and retype the password in the **Retype** text box.
10. Click **OK**.
11. To edit the details for a particular user, select the user and click **Edit**.
12. To delete a particular user, select the user and click **Delete**.
13. Click **OK** in the **Monitoring** tab.

Creating Community Strings for SNMPv3 Using the New WebUI

To create community strings for SNMPv3:

1. Go to **Configuration > System**.
2. Click the **Show advanced options** link.
3. Expand **Monitoring**.
4. Click **+** under the **Users for SNMPV3** box.
5. Enter the name of the user in the **Name** text box.
6. Select the type of authentication protocol from the **Authentication Protocol** drop-down list.
7. Enter the authentication password in the **Password** text box and retype the password in the **Retype** text box.
8. Select the type of privacy protocol from the **Privacy Protocol** drop-down list.
9. Enter the privacy protocol password in the **Password** text box and retype the password in the **Retype** text box.
10. Click **OK**.
11. To edit the details for a particular user, select the user and edit.
12. To delete a particular user, select the user and delete.
13. Click **Save**.

Configuring SNMP Community Strings in the CLI

To configure an SNMP engine ID and host:

```
(Instant AP) (config)# snmp-server engine-id <engine-ID>
(Instant AP) (config)# host <ipaddr> version {1 <name> udp-port <port>}|{2c|3 <name> [inform]
[udp-port <port>]}
```

To configure SNMPv1 and SNMPv2 community strings:

```
(Instant AP) (config)# snmp-server community <password>
```

To configure SNMPv3 community strings:

```
(Instant AP) (config)# snmp-server user <name> <auth-protocol> <password> <privacy-protocol>
<password>
```

To view SNMP configuration:

```
(Instant AP)# show snmp-configuration
Engine ID:D8C7C8C44298
Community Strings
-----
Name
----
```

SNMPv3 Users

Name	Authentication Type	Encryption Type
------	---------------------	-----------------

SNMP Trap Hosts

IP Address	Version	Name	Port	Inform
------------	---------	------	------	--------

Configuring SNMP Traps

AOS-W Instant supports the configuration of external trap receivers. Only the OAW-IAP acting as the virtual switch generates traps. The traps for OAW-IAP cluster are generated with virtual switch IP as the source IP, if virtual switch IP is configured. The OID of the traps is 1.3.6.1.4.1.14823.2.3.3.1.200.2.X.

You can configure SNMP traps by using the WebUI or the CLI.

In the Old WebUI

To configure an SNMP trap receiver:

1. Navigate to **System > Show advanced options > Monitoring**.
2. Under **SNMP Traps**, click **New**. The **New SNMP Trap Receiver** window is displayed.
3. Enter the following information:
 - **IP Address**—Enter the **IP Address** of the new SNMP Trap receiver.
 - **Version**—Select the SNMP version— **v1**, **v2c**, **v3** from the drop-down list. The version specifies the format of traps generated by the access point.
 - **Community/Username**—Specify the community string for SNMPv1 and SNMPv2c traps and a username for SNMPv3 traps.
 - **Port**—Enter the port to which the traps are sent. The default value is 162.
 - **Inform**—When enabled, traps are sent as SNMP INFORM messages. It is applicable to SNMPv3 only. The default value is **Yes**.
4. Click **OK**. The trap receiver information will be displayed in the **SNMP Trap Receivers** window.
5. Click **OK** in the **Monitoring** tab.

In the New WebUI

To configure an SNMP trap receiver:

1. Navigate to **Configuration > System**.
2. Click **Show advanced options**.
3. Expand **Monitoring**.
4. Go to the **SNMP** section.
5. Under **SNMP Trap Receivers**, click **+** and update the following information in the window that is displayed:
 - **IP address**—Enter the **IP Address** of the new SNMP Trap receiver.
 - **Version**—Select the SNMP version— **v1**, **v2c**, **v3** from the drop-down list. The version specifies the format of traps generated by the access point.
 - **Community/Username**—Specify the community string for SNMPv1 and SNMPv2c traps and a username for SNMPv3 traps.
 - **Port**—Enter the port to which the traps are sent. The default value is 162.
 - **Inform**—When enabled, traps are sent as SNMP INFORM messages. It is applicable to SNMPv3 only. The default value is **Yes**.

6. Click **OK**. The trap receiver information will be displayed in the **SNMP Trap Receivers** window.
7. Click **Save**.

In the CLI

To configure SNMP traps:

```
(Instant AP) (config)# snmp-server host <IP-address> {version 1 | version 2 | version 3} <name>  
udp-port <port> inform
```



OAW-IAPs support SNMP MIBs along with AOS-W Instant MIBs. For information about MIBs and SNMP traps, refer to the *Alcatel-Lucent AOS-W Instant MIB Reference Guide*.

Configuring a Syslog Server

You can specify a syslog server for sending syslog messages to the external servers by using the WebUI or the CLI.

In the Old WebUI

To configure a Syslog server and Syslog facility levels:

1. In the AOS-W Instant main window, click the **System** link.
2. Click **Show advanced options** to display the advanced options.
3. Click the **Monitoring** tab.
4. In the **Syslog server** text box which is in the **Servers** section, enter the IP address of the server to which you want to send system logs.



The syslog source address is sent individually by the OAW-IAPs in the cluster and never the virtual switch IP. Even the master OAW-IAP sends the syslog source address from its actual IP address.

5. Select the required values to configure syslog facility levels. Syslog Facility is an information field associated with a syslog message. It is an application or operating system component that generates a log message. The following seven facilities are supported by Syslog:

- **Ap-Debug**—Detailed log about the OAW-IAP device.
- **Network**—Log about change of network; for example, when a new OAW-IAP is added to a network.
- **Security**—Log about network security; for example, when a client connects using wrong password.
- **System**—Log about configuration and system status.
- **User**—Important logs about client.
- **User-Debug**—Detailed logs about client debugging.
- **Wireless**—Log about radio.

The following table describes the logging levels in the **Syslog** drop-down list, in order of severity from the most severe to the least severe.

Table 121: Logging Levels

Logging Level	Description
Emergency	Panic conditions that occur when the system becomes unusable.
Alert	Any condition requiring immediate attention and correction.
Critical	Any critical conditions such as a hard drive error.
Errors	Error conditions.
Warning	Warning messages.
Notice	Significant events of a noncritical and normal nature. The default value for all Syslog facilities.
Information	Messages of general interest to system users.
Debug	Messages containing information useful for debugging.

6. Click **OK**.

In the New WebUI

To configure a Syslog server and Syslog facility levels:

1. Go to **Configuration > System**.
2. Click **Show advanced options**.
3. Expand **Monitoring**.
4. In the **Syslog server** text box which is in the **Servers** section, enter the IP address of the server to which you want to send system logs.



The syslog source address is sent individually by the OAW-IAPs in the cluster and never the virtual switch IP. Even the master OAW-IAP sends the syslog source address from its actual IP address.

5. In the **Syslog Facility Levels** section, select the required values to configure syslog facility levels. Syslog Facility is an information field associated with a syslog message. It is an application or operating system component that generates a log message. The following seven facilities are supported by Syslog:

- **System**—Log about configuration and system status.
- **Ap-Debug**—Detailed log about the OAW-IAP device.
- **User**—Important logs about client.
- **Network**—Log about change of network; for example, when a new OAW-IAP is added to a network.
- **User-Debug**—Detailed logs about client debugging.
- **Security**—Log about network security; for example, when a client connects using wrong password.
- **Wireless**—Log about radio.

The following table describes the logging levels in the **Syslog** drop-down list, in order of severity from the most severe to the least severe.

Table 122: Logging Levels

Logging Level	Description
Emergency	Panic conditions that occur when the system becomes unusable.
Alert	Any condition requiring immediate attention and correction.
Critical	Any critical conditions such as a hard drive error.
Error	Error conditions.
Warning	Warning messages.
Notice	Significant events of a noncritical and normal nature. The default value for all Syslog facilities.
Info	Messages of general interest to system users.
Debug	Messages containing information useful for debugging.

6. Click **Save**.

In the CLI

To configure a syslog server:

```
(Instant AP) (config)# syslog-server <IP-address>
```

To configure syslog facility levels:

```
(Instant AP) (config)# syslog-level <logging-level>[ap-debug |network |security |system |user |user-debug | wireless]
```

To view syslog logging levels:

```
(Instant AP)# show syslog-level
```

```
Logging Level
-----
Facility   Level
-----
ap-debug   warn
network    warn
security   warn
system     warn
user       warn
user-debug warn
wireless   error
```

Configuring TFTP Dump Server

You can configure a TFTP server for storing core dump files by using the WebUI or the CLI.

In the Old WebUI

To configure a TFTP server:

1. In the AOS-W Instant main window, click the **System** link.
2. Click **Show advanced options** to display the advanced options.
3. Click the **Monitoring** tab.
4. Enter the IP address of the TFTP server in the **TFTP Dump Server** text box.

5. Click **OK**.

In the New WebUI

To configure a TFTP server:

1. Go to **Configuration > System**.
2. Click **Show advanced options**.
3. Expand **Monitoring**.
4. In the **Servers** section, enter the IP address of the TFTP server in the **TFTP Dump Server** text box.
5. Click **Save**.

In the CLI

To configure a TFTP server:

```
(Instant AP) (config) # tftp-dump-server <IP-address>
```

Running Debug Commands

You can run the debugging commands using the WebUI or the CLI.

In the Old WebUI

To run the debugging commands:

1. Navigate to **More > Support** on the AOS-W Instant main window.
2. Select the required option from the **Command** drop-down list.
3. Select **All Access Points** or **Instant Access Point(VC)** from the **Target** drop-down list.
4. Click **Run** and then click **Save**. The output of all the selected commands is displayed in a single page.

In the New WebUI

To run the debugging commands:

1. Select **Support** from the left pane of the AOS-W Instant main window.
2. Select the required option from the **Command** drop-down list.
3. Select **All Access Points** or **Instant Access Point (VC)** from the **Target** drop-down list.
4. Click **Run** and then click **Save**. The output of all the selected commands is displayed in the same page. Additionally, the output of all the selected commands is displayed in the **Console** page.



The **Support** window allows you to run commands for each access point and virtual switch in a cluster.

In the CLI

For a complete list of commands supported in a particular release train, execute the **show support-commands** command at the OAW-IAP CLI. The output of this command displays the list of support commands that you can run through the WebUI and the corresponding CLI commands. For more information on these commands, refer to the respective command page in the *Alcatel-Lucent AOS-W Instant CLI Reference Guide*.

```
(Instant AP) # show support-commands
Support Commands
```

```
-----
Description
```

```
Command Name
```

```
-----
```

```
-----
```

AP Tech Support Dump	show tech-support
AP Tech Support Dump Supplemental	show tech-support supplemental
AP Provisioning Status	show activate status
AP 3G/4G Status	show cellular status
AP 802.1X Statistics	show ap debug dot1x-statistics
AP Access Rule Table	show access-rule-all
AP Inbound Firewall Rules	show inbound-firewall-rules
AP Active	show aps
AP AirGroup Cache	show airgroup cache entries
AP AirGroup CPPM Entries	show airgroup cppm entries
AP AirGroup CPPM Servers	show airgroup cppm server
AP AirGroup Debug Statistics	show airgroup debug statistics
AP AirGroup Servers	show airgroup servers verbose
AP AirGroup User	show airgroup users verbose
AP ALE Configuration	show ale config
AP ALE Status	show ale status
AP Allowed Channels	show ap allowed-channels
AP Allowed MAX-EIRP	show ap allowed-max-EIRP
AP All Supported Timezones	show clock timezone all
AP ARM Bandwidth Management	show ap arm bandwidth-management
AP ARM Channels	show arm-channels
AP ARM Configuration	show arm config
AP ARM History	show ap arm history
AP ARM Neighbors	show ap arm neighbors
AP ARM RF Summary	show ap arm rf-summary
AP ARM Scan Times	show ap arm scan-times
AP ARP Table	show arp
AP Association Table	show ap association
AP Authentication Frames	show ap debug auth-trace-buf
AP Auth-Survivability Cache	show auth-survivability cached-info
AP Auth-Survivability Debug Log	show auth-survivability debug-log
AP BSSID Table	show ap bss-table
AP Captive Portal Domains	show captive-portal-domains
AP Captive Portal Auto White List	show captive-portal auto-white-list
AP Client Match Status	show ap debug client-match
AP Client Match History	show ap client-match-history
AP Client Match Action	show ap client-match-actions
AP Client Match Live	show ap client-match-live
AP Client Match Triggers	show ap client-match-triggers
AP Client Table	show ap debug client-table
AP Client View	show ap client-view
AP Country Codes	show country-codes
AP CPU Details	show cpu details
AP CPU Utilization	show cpu
AP Crash Info	show ap debug crash-info
AP Current Time	show clock
AP Current Timezone	show clock timezone
AP Datapath ACL Table Allocation	show datapath acl-allocation
AP Datapath ACL Tables	show datapath acl-all
AP Datapath Bridge Table	show datapath bridge
AP Datapath DMO session	show datapath dmo-session
AP Datapath DMO station	show datapath dmo-station
AP Datapath Dns Id Map	show datapath dns-id-map
AP Datapath Multicast Table	show datapath mcast
AP Datapath Nat Pool	show datapath nat-pool
AP Datapath Route Table	show datapath route
AP Datapath Session Table	show datapath session
AP Datapath DPI Session Table	show datapath session dpi
AP Datapath DPI Session Table Verbose	show datapath session dpi verbose
AP Datapath Statistics	show datapath statistics
AP Datapath User Table	show datapath user
AP Datapath VLAN Table	show datapath vlan

AP DPI Debug statistics	show dpi debug statistics
AP Daylight Saving Time	show clock summer-time
AP Derivation Rules	show derivation-rules
AP Driver Configuration	show ap debug driver-config
AP Election Statistics	show election statistics
AP External Captive Portal Status	show external-captive-portal
AP Environment Variable	show ap-env
AP ESSID Table	show network
AP Flash Configuration	show ap flash-config
AP IGMP Group Table	show ip igmp
AP Interface Counters	show interface counters
AP Interface Status	show port status
AP Internal DHCP Status	show dhcp-allocation
AP IP Interface	show ip interface brief
AP IP Route Table	show ip route
AP L3 Mobility Datapath	show l3-mobility datapath
AP L3 Mobility Events log	show log l3-mobility
AP L3 Mobility Status	show l3-mobility status
AP LACP Status	show lacp status
AP Log All	show log debug
AP Log AP-Debug	show log ap-debug
AP Log Conversion	show log convert
AP Log Driver	show log driver
AP Log Kernel	show log kernel
AP Log Network	show log network
AP Log PPPd	show log pppd
AP Log Rapper	show log rapper
AP Log Rapper Counter	show log rapper-counter
AP Log Rapper Brief	show log rapper-brief
AP Log Sapid	show log sapd
AP Log Security	show log security
AP Log System	show log system
AP Log Tunnel Status Management	show log apifmgr
AP Log Upgrade	show log upgrade
AP Log User-Debug	show log user-debug
AP Log User	show log user
AP Log VPN Tunnel	show log vpn-tunnel
AP Log Wireless	show log wireless
AP Management Frames	show ap debug mgmt-frames
AP Memory Allocation State Dumps	show malloc-state-dumps
AP Memory Utilization	show memory
AP Mesh Counters	show ap mesh counters
AP Mesh Link	show ap mesh link
AP Mesh Neighbors	show ap mesh neighbours
AP Monitor Active Laser Beams	show ap monitor active-laser-beams
AP Monitor AP Table	show ap monitor ap-list
AP Monitor ARP Cache	show ap monitor ARP Cache
AP Monitor Client Table	show ap monitor sta-list
AP Monitor Containment Information	show ap monitor containment-info
AP Monitor Potential AP Table	show ap monitor pot-ap-list
AP Monitor Potential Client Table	show ap monitor pot-sta-list
AP Monitor Router	show ap monitor routers
AP Monitor Scan Information	show ap monitor scan-info
AP Monitor Status	show ap monitor status
AP Persistent Clients	show ap debug persistent-clients
AP PMK Cache	show ap pmkcache
AP PPPoE uplink debug	show pppoe debug-logs
AP PPPoE uplink status	show pppoe status
AP Processes	show process
AP Radio 0 Client Probe Report	show ap client-probe-report 0
AP Radio 0 Stats	show ap debug radio-stats 0
AP Radio 0 info	show ap debug radio-info 0

AP Radio 1 Client Probe Report	show ap client-probe-report 1
AP Radio 1 Stats	show ap debug radio-stats 1
AP Radio 1 info	show ap debug radio-info 1
AP RADIUS Statistics	show ap debug radius-statistics
AP Termination RADIUS Statistics	show ap debug radius-statistics termination
AP Shaping Table	show ap debug shaping-table
AP Sockets	show socket
AP STM Configuration	show ap debug stm-config
AP Swarm State	show swarm state
AP System Status	show ap debug system-status
AP System Summary	show summary support
AP Uplink Status	show uplink status
AP User Table	show clients
AP Valid Channels	show valid-channels
AP Version	show version
AP Virtual Beacon Report	show ap virtual-beacon-report
AP VPN Config	show vpn config
AP VPN Status	show vpn status
AP IAP-VPN Retry Counters	show vpn tunnels
AP Wired Port Settings	show wired-port-settings
AP Wired User Table	show clients wired
AP Checksum	show ap checksum
AP Spectrum AP table	show ap spectrum ap-list
AP Spectrum channel table	show ap spectrum channel-details
AP Spectrum channel metrics	show ap spectrum channel-metrics
AP Spectrum channel summary	show ap spectrum channel-summary
AP Spectrum client table	show ap spectrum client-list
AP Spectrum device duty cycle	show ap spectrum device-duty-cycle
AP Spectrum non-wifi device history	show ap spectrum device-history
AP Spectrum non-wifi device table	show ap spectrum device-list
AP Spectrum non-wifi device log	show ap spectrum device-log
AP Spectrum number of device	show ap spectrum device-summary
AP Spectrum interference-power table	show ap spectrum interference-power
AP Spectrum status	show ap spectrum status
VC 802.1x Certificate	show lxcert
VC All Certificates	show cert all
VC radsec Certificates	show radseccert
VC Captive Portal domains	show captive-portal-domains
VC About	show about
VC Active Configuration	show running-config
VC AirGroup Service	show airgroupservice
VC AirGroup Status	show airgroup status
VC Allowed AP Table	show allowed-aps
VC AMP Status	show ap debug airwave
VC AMP Current State Data	show ap debug airwave-state
VC AMP Current Stats Data	show ap debug airwave-stats
VC AMP Data Sent	show ap debug airwave-data-sent
VC AMP Events Pending	show ap debug airwave-events-pending
VC AMP Last Configuration Received	show ap debug airwave-config-received
VC AMP Single Sign-on Key	show ap debug airwave-signon-key
VC AMP Configuration Restore Status	show ap debug airwave-restore-status
VC Central Current State Data	show ap debug cloud-state
VC Central Current Stats Data	show ap debug cloud-stats
VC Central Data Sent	show ap debug cloud-data-sent
VC Central Events Pending	show ap debug cloud-events-pending
VC Central Last Configuration Received	show ap debug cloud-config-received
VC Central Single Sign-on Key	show ap debug cloud-signon-key
VC Central Configuration Restore Status	show ap debug cloud-restore-status
VC Application Services	show app-services
VC Cloud Server Status	show ap debug cloud-server
VC DHCP Option 43 Received	show dhcpc-opts
VC Global Alerts	show alert global

VC Global Statistics	show stats global
VC IDS AP List	show ids aps
VC IDS Client List	show ids clients
VC Internal DHCP Server Configuration	show ip dhcp database
VC Local User Database	show users
VC OpenDNS Configuration and Status	show opendns support
VC Provisioning Log	show log provision
VC Radius Attributes	show radius-attributes
VC Radius Servers	show radius-servers support
AP Radius Status	show radius status
VC Saved Configuration	show configuration
VC Scanning Stats	show aps scanning
VC Show SBR Table	show datapath sbr
VC SNMP Configuration	show snmp-configuration
VC Uplink 3G/4G Configuration	show cellular config
VC Uplink Management Configuration	show uplink config
VC WISPr Configuration	show wispr config
VC XML API Server Information	show xml-api-server
VC rfc3576-radius statistics	show ap debug rfc3576-radius-statistics



Use the **support** commands under the supervision of Alcatel-Lucent technical support.

Uplink Bandwidth Monitoring

An OAW-IAP uses Iperf3 as a TCP or UDP client to run a speed test and measure the bandwidth on an uplink. The results from the speed test are collated by the OAW-IAP and published to ALE. Speed tests can be run only on master OAW-IAPs. They cannot be run on slave OAW-IAPs.

You may choose to configure and execute a speed test profile during boot time and additionally at specific time intervals using the configuration mode or execute the speed test at any preferred time using the privileged EXEC mode in the CLI.

To configure and automatically run speed tests at specific time intervals:

```
(Instant AP) (config)# speed-test
(Instant AP) (speed-test)# include-reverse
(Instant AP) (speed-test)# server-ip <server>
(Instant AP) (speed-test)# server-port <port>
(Instant AP) (speed-test)# on-boot
(Instant AP) (speed-test)# omit
(Instant AP) (speed-test)# protocol <tcp/udp>
(Instant AP) (speed-test)# parallel
(Instant AP) (speed-test)# time-interval <interval>
(Instant AP) (speed-test)# bandwidth <bandwidth>
(Instant AP) (speed-test)# sec-to-measure <secs>
(Instant AP) (speed-test)# window
```

To configure and execute a speed test at any preferred time:

```
(Instant AP) (config)# speed-test 10.17.144.8 tcp include-reverse sec-to-measure 10 server-
port 5201 parallel 10 omit 1 window 512
```

To view the speed test results:

```
(Instant AP)# show speed-test data
```

The following command shows the number of times the uplink bandwidth report was sent to the ALE server.

To display the uplink bandwidth counter:

```
(Instant AP)# show ale stats
ALE Stats
-----
```

```
Type Value
---- -----
VC package 0
RSSI package 0
APPRF package 0
URLv package 0
STATE package 0
STAT package 0
UPLINK BW package 0
Total 0
```

This chapter contains the following topics:

- [Understanding Hotspot Profiles on page 487](#)
- [Configuring Hotspot Profiles on page 489](#)
- [Sample Configuration on page 503](#)



In the current release, AOS-W Instant supports the hotspot profile configuration only through the CLI.

Understanding Hotspot Profiles

Hotspot 2.0 R1 is a WFA specification based on the 802.11u protocol, which allows wireless clients to discover hotspots using management frames (such as beacon, association request, and association response), connect to networks, and roam between networks without additional authentication.

Hotspot 2.0 provides the following services:

- Network discovery and selection—Allows the clients to discover suitable and available networks by advertising the access network type, roaming consortium, and venue information through the management frames. For network discovery and selection, GAS and ANQP are used.
- QoS Mapping—Provides a mapping between the network-layer QoS packet marking and over-the-air QoS frame marking based on user priority.

Starting from Alcatel-Lucent AOS-W Instant 8.3.0.0, the Hotspot 2.0 R2 is introduced. This feature is supported on all OAW-IAPs except the 5xx series access points. This release supports the following new features:

- Online Sign-Up—Mobile devices use Online Sign-Up (OSU) for registration and credential provisioning to obtain secure network access using the service provider's OSU server.
- WNM Subscription Remediation—Subscription remediation is a process that Home Service Providers use to correct, update, and resolve subscription issues. WNM(11v) is used for Subscription Remediation.

When a hotspot is configured in a network:

- The clients search for available hotspots using the beacon management frame.
- When a hotspot is found, the client sends queries to obtain information about the type of network authentication and IP address, and IP address availability using the GAS action frames.
- Based on the response of the advertisement server (response to the GAS Action Frames), the relevant hotspot is selected and the client attempts to associate with it.
- Based on the authentication mode used for mobility clients, the client authenticates to access the network.

GAS

GAS is a request-response protocol, that provides L2 transport mechanism between a wireless client and a server in the network prior to authentication. It helps to determine an 802.11 infrastructure before associating clients and allows clients to send queries to multiple 802.11 networks in parallel.

An OAW-IAP can include its SP Organization Identifier indicating the identity of the SP in beacons and probe responses to clients. When a client recognizes an OAW-IAP's OI, it attempts to associate to that OAW-IAP using the security credentials corresponding to that SP. If the client does not recognize the AP's OI, the client sends a GAS query to the OAW-IAP to request more information about the network before associating. A client

transmits a GAS Query using a GAS Initial Request frame and the OAW-IAP provides the query response or information on how to receive the query response in a GAS Initial Response frame. To transmit a GAS query for any advertisement protocol, the advertisement protocol ID must include the advertisement protocol information element with details of the advertisement protocol and its corresponding advertisement control.

ANQP

ANQP provides a range of information, such as IP address type and availability, roaming partners accessible through a hotspot, and the EAP method supported for authentication, for a query and response protocol. The ANQP Information Elements provide additional data that can be sent from an OAW-IAP to the client to identify the OAW-IAP's network and service provider. If a client requests this information through a GAS query, the hotspot OAW-IAP sends the ANQP capability list in the GAS Initial Response frame indicating support for the following IEs:

- Venue Name
- Domain Name
- Network Authentication Type
- Roaming Consortium List
- Network Access Identifier Realm
- 3GPP Cellular Network Data
- IP Address Availability

H2QP

The H2QP profiles provide a range of information on Hotspot 2.0 elements such as hotspot protocol and port, operating-class, operator names, WAN status, OSU provider list, and uplink and downlink metrics.

Information Elements and Management Frames

The Hotspot 2.0 configuration supports the following IEs:

- Interworking IE—Provides information about the Interworking service capabilities such as the Internet availability in a specific service provider network.
- Advertisement Protocol IE—Provides information about the advertisement protocol that a client can use for communication with the advertisement servers in a network.
- Roaming Consortium IE—Provides information about the service provider network for roaming clients, which can be used to authenticate with the OAW-IAP.

The IEs are included in the following Management Frames when 802.11u is enabled:

- Beacon Frame
- Probe Request Frame
- Probe Response frame
- Association Request
- Re-Association request

Network Access Identifier Realm List

A Network Access Identifier Realm profile identifies and describes a NAI realm to which the clients can connect. The NAI realm settings on an OAW-IAP act as an advertisement profile to determine the NAI realm elements that must be included as part of a GAS Response frame.

Configuring Hotspot Profiles

To configure a hotspot profile, perform the following steps:

1. [Create the required ANQP and H2QP advertisement profiles.](#)
2. [Create a hotspot profile.](#)
3. [Associate the required ANQP and H2QP advertisement profiles created in step 1 to the hotspot profile created in step 2.](#)
4. [Create an SSID Profile with enterprise security and WPA-2 encryption settings and then associate the SSID with the hotspot profile created in step 2.](#)

Creating Advertisement Profiles for Hotspot Configuration

A hotspot profile contains one or several advertisement profiles. The following advertisement profiles can be configured through the AOS-W Instant CLI:

- ANQP advertisement profiles
 - [NAI Realm profile](#)
 - [Venue Name Profile](#)
 - [Network Authentication Profile](#)
 - [Roaming Consortium Profile](#)
 - [3GPP Profile](#)
 - [IP Address availability Profile](#)
 - [Domain Name Profile](#)
- H2QP advertisement profiles
 - [Operator Friendly Name Profile](#)
 - [Connection Capability Profile](#)
 - [Operating-Class Profile](#)
 - [WAN-Metrics Profile](#)
 - [OSU Provider Profile](#)

Configuring an NAI Realm Profile

You can configure a Network Access Identifier Realm profile to define the NAI realm information, which can be sent as an ANQP IE in a GAS query response.

To configure a NAI profile:

```
(Instant AP) (config)# hotspot anqp-nai-realm-profile <name>
(Instant AP) (nai-realm <name>)# nai-realm-name <name>
(Instant AP) (nai-realm <name>)# nai-realm-encoding {<utf8>|<rfc4282>}
(Instant AP) (nai-realm <name>)# nai-realm-eap-method <eap-method>
(Instant AP) (nai-realm <name>)# nai-realm-auth-id-1 <authentication-ID>
(Instant AP) (nai-realm <name>)# nai-realm-auth-id-2 <authentication-ID>
(Instant AP) (nai-realm <name>)# nai-realm-auth-value-1 <authentication-value>
(Instant AP) (nai-realm <name>)# nai-realm-auth-value-2 <authentication-value>
(Instant AP) (nai-realm <name>)# nai-home-realm
(Instant AP) (nai-realm <name>)# enable
```

You can specify any of the following EAP methods for the **nai-realm-eap-method <eap-method>** command:

- **identity**—To use EAP Identity type. The associated numeric value is 1.
- **notification**—To allow the hotspot realm to use EAP Notification messages for authentication. The associated numeric value is 2.
- **one-time-password**—To use Authentication with a single-use password. The associated numeric value is 5.

- **generic-token-card**—To use EAP-GTC. The associated numeric value is 6.
- **eap-tls**—To use EAP-TLS. The associated numeric value is 13.
- **eap-sim**—To use EAP for GSM SIM. The associated numeric value is 18.
- **eap-ttls**—To use EAP-TTLS. The associated numeric value is 21.
- **peap**—To use PEAP. The associated numeric value is 25.
- **crypto-card**—To use crypto card authentication. The associated numeric value is 28.
- **peapmschapv2**—To use PEAP with MSCHAPv2. The associated numeric value is 29.
- **eap-aka**—To use EAP for UMTS Authentication and Key Agreement. The associated numeric value is 50.

The following table lists the possible authentication IDs and their respective values:

Table 123: NAI Realm Profile Configuration Parameters

Authentication ID	Authentication Value
reserved <ul style="list-style-type: none"> ■ Uses the reserved authentication method. ■ The associated numeric value is 0. 	—
expanded-eap <ul style="list-style-type: none"> ■ Uses the expanded EAP authentication method. ■ The associated numeric value is 1. 	Use expanded-eap as the authentication value.
non-eap-inner-auth <ul style="list-style-type: none"> ■ Uses non-EAP inner authentication type. ■ The associated numeric value is 2. 	The following authentication values apply: <ul style="list-style-type: none"> ■ reserved—The associated numeric value is 0. ■ pap—The associated numeric value is 1. ■ chap—The associated numeric value is 2. ■ mschap—The associated numeric value is 3. ■ mschapv2—The associated numeric value is 4.
eap-inner-auth <ul style="list-style-type: none"> ■ Uses EAP inner authentication type. ■ The associated numeric value is 3. 	The following authentication values apply: <ul style="list-style-type: none"> ■ reserved—The associated numeric value is 0. ■ pap—The associated numeric value is 1. ■ chap—The associated numeric value is 2. ■ mschap—The associated numeric value is 3. ■ mschapv2—The associated numeric value is 4.
exp-inner-eap <ul style="list-style-type: none"> ■ Uses the expanded inner EAP authentication method. ■ The associated numeric value is 4. 	Use the exp-inner-eap authentication value.
credential <ul style="list-style-type: none"> ■ Uses credential authentication. ■ The associated numeric value is 5. 	The following authentication values apply: <ul style="list-style-type: none"> ■ sim—The associated numeric value is 1. ■ usim—The associated numeric value is 2. ■ nfc-secure—The associated numeric value is 3. ■ hw-token—The associated numeric value is 4. ■ softoken—The associated numeric value is 5. ■ certificate—The associated numeric value is 6. ■ uname-password—The associated numeric value is 7. ■ none—The associated numeric value is 8. ■ reserved—The associated numeric value is 9. ■ vendor-specific—The associated numeric value is 10.

Configuring a Venue Name Profile

You can configure a venue name profile to send the venue information as an ANQP IE in a GAS query response.

To configure a venue name profile:

```
(Instant AP) (config)# hotspot anqp-venue-name-profile <name>
(Instant AP) (venue-name <name>)# venue-name <name>
(Instant AP) (venue-name <name>)# venue-group <group-name>
(Instant AP) (venue-name <name>)# venue-type <type>
(Instant AP) (venue-name <name>)# venue-lang-code <language>
(Instant AP) (venue-name <name>)# enable
```

You can specify any of the following venue groups and the corresponding venue types:

Table 124: Venue Types

Venue Group	Associated Venue Type Value
unspecified The associated numeric value is 0 .	—
assembly The associated numeric value is 1 .	<ul style="list-style-type: none"> ■ unspecified—The associated numeric value is 0. ■ arena—The associated numeric value is 1. ■ stadium—The associated numeric value is 2. ■ passenger-terminal—The associated numeric value is 3. ■ amphitheater—The associated numeric value is 4. ■ amusement-park—The associated numeric value is 5. ■ place-of-worship—The associated numeric value is 6. ■ convention-center—The associated numeric value is 7. ■ library—The associated numeric value is 8. ■ museum—The associated numeric value is 9. ■ restaurant—The associated numeric value is 10. ■ theater—The associated numeric value is 11. ■ bar—The associated numeric value is 12. ■ coffee-shop—The associated numeric value is 13. ■ zoo-or-aquarium—The associated numeric value is 14. ■ emergency-cord-center—The associated numeric value is 15.
business The associated numeric value is 2 .	<ul style="list-style-type: none"> ■ unspecified—The associated numeric value is 0. ■ doctor—The associated numeric value is 1. ■ bank—The associated numeric value is 2. ■ fire-station—The associated numeric value is 3. ■ police-station—The associated numeric value is 4. ■ post-office—The associated numeric value is 6. ■ professional-office—The associated numeric value is 7. ■ research-and-dev-facility—The associated numeric value is 8. ■ attorney-office—The associated numeric value is 9.
educational The associated numeric value is 3 .	<ul style="list-style-type: none"> ■ unspecified—The associated numeric value is 0. ■ school-primary—The associated numeric value is 1. ■ school-secondary—The associated numeric value is 2. ■ univ-or-college—The associated numeric value is 3.
factory-and-industrial The associated numeric value is 4 .	<ul style="list-style-type: none"> ■ unspecified—The associated numeric value is 0. ■ factory—The associated numeric value is 1.
institutional The associated numeric value is 5 .	<ul style="list-style-type: none"> ■ unspecified—The associated numeric value is 0. ■ hospital—The associated numeric value is 1. ■ long-term-care—The associated numeric value is 2. ■ alc-drug-rehab—The associated numeric value is 3. ■ group-home—The associated numeric value is 4.

Table 124: Venue Types

Venue Group	Associated Venue Type Value
	<ul style="list-style-type: none"> ■ prison-or-jail—The associated numeric value is 5.
mercantile The associated numeric value is 6 .	<ul style="list-style-type: none"> ■ unspecified—The associated numeric value is 0. ■ retail-store—The associated numeric value is 1. ■ grocery-market—The associated numeric value is 2. ■ auto-service-station—The associated numeric value is 3. ■ shopping-mall—The associated numeric value is 4. ■ gas-station—The associated numeric value is 5
residential The associated numeric value is 7 .	<ul style="list-style-type: none"> ■ unspecified—The associated numeric value is 0. ■ private-residence—The associated numeric value is 1. ■ hotel—The associated numeric value is 2. ■ dormitory—The associated numeric value is 3. ■ boarding-house—The associated numeric value is 4.
storage The associated numeric value is 8 .	unspecified—The associated numeric value is 0 .
utility-misc The associated numeric value is 9 .	unspecified—The associated numeric value is 0 .
vehicular The associated numeric value is 10 .	<ul style="list-style-type: none"> ■ unspecified—The associated numeric value is 0. ■ automobile-or-truck—The associated numeric value is 1. ■ airplane—The associated numeric value is 2. ■ bus—The associated numeric value is 3. ■ ferry—The associated numeric value is 4. ■ ship—The associated numeric value is 5. ■ train—The associated numeric value is 6. ■ motor-bike—The associated numeric value is 7.
outdoor The associated numeric value is 11 .	<ul style="list-style-type: none"> ■ unspecified—The associated numeric value is 0 ■ muni-mesh-network—The associated numeric value is 1. ■ city-park—The associated numeric value is 2. ■ rest-area—The associated numeric value is 3. ■ traffic-control—The associated numeric value is 4. ■ bus-stop—The associated numeric value is 5. ■ kiosk—The associated numeric value is 6.

Configuring a Network Authentication Profile

You can configure a network authentication profile to define the authentication type used by the hotspot network.

To configure a network authentication profile:

```
(Instant AP) (config)# hotspot anqp-nwk-auth-profile <name>
(Instant AP) (network-auth <name>)# nwk-auth-type <type>
(Instant AP) (network-auth <name>)# url <URL>
(Instant AP) (network-auth <name>)# enable
```

You can specify any of the following network authentication type for the **nwk-auth-type <type>** command:

- **accept-term-and-cond**—When configured, the network requires the user to accept terms and conditions. This option requires you to specify a redirection URL string as an IP address, FQDN or URL.
- **online-enrollment**—When configured, the network supports the online enrollment.
- **http-redirect**—When configured, additional information on the network is provided through HTTP or HTTPS redirection.

- **dns-redirect**—When configured, additional information on the network is provided through DNS redirection. This option requires you to specify a redirection URL string as an IP address, FQDN, or URL.

Configuring a Roaming Consortium Profile

You can configure a roaming consortium profile to send the roaming consortium information as an ANQP IE in a GAS query response.

To configure a roaming consortium profile:

```
(Instant AP) (config)# hotspot anqp-roam-cons-profile <name>
(Instant AP) (roaming-consortium <name>)# roam-cons-oi <roam-cons-oi>
(Instant AP) (roaming-consortium <name>)# roam-cons-oi-len <roam-cons-oi-len>
(Instant AP) (roaming-consortium <name>)# enable
```

Specify a hexadecimal string of 3–5 octets for **roam-cons-oi <roam-cons-oi>**.

Based on the organization identifier specified, you can specify the following parameters for the length of organization identifier in **roam-cons-oi-len <roam-cons-oi-len>**.

- For 0: 0 Octets in the organization identifier (Null)
- For 3: OI length is 24-bits (3 Octets)
- For 5: OI length is 36-bits (5 Octets)

Configuring a 3GPP Profile

You can configure a 3GPP profile to define information for the 3G Cellular Network for hotspots.

To configure a 3GPP profile:

```
(Instant AP) (config)# hotspot anqp-3gpp-profile <name>
(Instant AP) (3gpp <name>)# 3gpp-plmn1 <plmn-ID>
(Instant AP) (3gpp <name>)# enable
```

The PLMN ID is a combination of the mobile country code and network code. You can specify up to 6 PLMN IDs for a 3GPP profile.

Configuring an IP Address Availability Profile

You can configure an available IP address types to send information on IP address availability as an ANQP IE in a GAS query response.

To configure an IP address availability profile:

```
(Instant AP) (config)# hotspot anqp-ip-addr-avail-profile <name>
(Instant AP) (IP-addr-avail <name>)# ipv4-addr-avail
(Instant AP) (IP-addr-avail <name>)# ipv6-addr-avail
(Instant AP) (IP-addr-avail <name>)# enable
```

Configuring a Domain Profile

You can configure a domain profile to send the domain names as an ANQP IE in a GAS query response.

To configure a domain name profile, execute the following commands:

```
(Instant AP) (config)# hotspot anqp-domain-name-profile <name>
(Instant AP) (domain-name <name>)# domain-name <domain-name>
(Instant AP) (domain-name <name>)# enable
```

Configuring an Operator-Friendly Profile

You can configure an operator-friendly name profile to define the identify the operator.

To configure an H2QP operator-friendly name profile:

```
(Instant AP) (config)# hotspot h2qp-oper-name-profile <name>
(Instant AP) (operator-friendly-name <name>)# op-fr-name <op-fr-name>
(Instant AP) (operator-friendly-name <name>)# op-lang-code <op-lang-code>
```

```
(Instant AP) (operator-friendly-name <name>)# enable
```

Configuring a Connection Capability Profile

You can configure a connection capability profile to define information such as the hotspot IP protocols and associated port numbers that are available for communication.

To configure an H2QP connection capability profile:

```
(Instant AP) (config) # hotspot h2qp-conn-cap-profile <name>
(Instant AP) (connection-capabilities <name>)# esp-port
(Instant AP) (connection-capabilities <name>)# icmp
(Instant AP) (connection-capabilities <name>)# tcp-ftp
(Instant AP) (connection-capabilities <name>)# tcp-http
(Instant AP) (connection-capabilities <name>)# tcp-pptp-vpn
(Instant AP) (connection-capabilities <name>)# tcp-ssh
(Instant AP) (connection-capabilities <name>)# tcp-tls-vpn
(Instant AP) (connection-capabilities <name>)# tcp-voip
(Instant AP) (connection-capabilities <name>)# udp-ike2
(Instant AP) (connection-capabilities <name>)# udp-ipsec-vpn
(Instant AP) (connection-capabilities <name>)# udp-voip
(Instant AP) (connection-capabilities <name>)# enable
```

Configuring an Operating-Class Profile

You can configure an operating-class profile to list the channels on which the hotspot is capable of operating.

To configure an H2QP operating-class profile:

```
(Instant AP) (config) # hotspot h2qp-oper-class-profile <name>
(Instant AP) (operator-class <name>)# op-class <class-ID>
(Instant AP) (operator-class <name>)# enable
```

Configuring a WAN Metrics Profile

You can configure a WAN metrics profile to define information about access network characteristics such as link status and metrics.

To configure a WAN metrics profile:

```
(Instant AP) (config)# hotspot h2qp-wan-metrics-profile <name>
(Instant AP) (WAN-metrics <name>)# at-capacity
(Instant AP) (WAN-metrics <name>)# downlink-load <load>
(Instant AP) (WAN-metrics <name>)# downlink-speed <speed>
(Instant AP) (WAN-metrics <name>)# load-duration <duration>
(Instant AP) (WAN-metrics <name>)# symm-link
(Instant AP) (WAN-metrics <name>)# uplink-load <load>
(Instant AP) (WAN-metrics <name>)# uplink-speed <speed>
(Instant AP) (WAN-metrics <name>)# wan-metrics-link-status <status>
```

You can specify the following WAN downlink and uplink parameters:

- **Downlink load**—Indicates the percentage of the WAN downlink currently utilized. The default value of 0 indicates that the downlink speed is unknown or unspecified.
- **Downlink speed**—Indicates the WAN downlink speed in Kbps.
- **Uplink load**—Indicates the percentage of the WAN uplink currently utilized. The default value of 0 indicates that the downlink speed is unknown or unspecified.
- **Uplink speed**—Indicates the WAN uplink speed in Kbps.
- **Load duration**—Indicates the duration in seconds during which the downlink utilization is measured.
- **Symmetric links**—Indicates if the uplink and downlink have the same speed.
- **WAN Link Status**—Indicates if the WAN is down (link-down), up (link-up), or in test state (link-under-test).

Configuring an OSU Provider Profile

You can create an OSU provider profile and attach them to a hotspot profile to enable wireless devices to use OSU. The OSU providers list element provides information for one or more entities offering OSU service. For each OSU provider, information such as friendly name (in one or more human languages), NAI(used to authenticate to the OSU ESS if configured for OSEN), icon(s), and URI of the OSU Server are provided.

Downloading Icon Files to OAW-IAP

To download the icon file to the OAW-IAP, execute the following command:

```
(Instant AP)# hs2-osu-icon-download <idx> <ftp/tftp/http URL syntax>
```



The maximum size supported for the icon file is 32 KB.

The icon file is downloaded from the specified location using the specified protocol and stored in the file system with the specified index as reference.

To Delete an icon file from OAW-IAP, execute the following command:

```
(Instant AP)# hs2-osu-icon-delete <idx>
```

Table 125: HS2 OSU Icon Download Parameters

Parameter	Description
<idx>	Indicates the index of the file which can take values from 1 to 16.
<url>	The protocol that is used to download the icon file. The protocol can be FTP, TFTP, or HTTP.

Configuring OSU Provider Profile Parameters

Use the following commands to create and configure various parameters of the OSU provider profile:

```
(Instant AP) (config) # hotspot h2qp-osu-provider-profile <name>
(Instant AP) (osu-provider <name>) # frnd-name-count <count>
(Instant AP) (osu-provider <name>) # frnd-name1-lang-code <lang code>
(Instant AP) (osu-provider <name>) # frnd-name1 <OSU Friendly name>
(Instant AP) (osu-provider <name>) # frnd-name1-hex <OSU Friendly name>
(Instant AP) (osu-provider <name>) # frnd-name2-lang-code <lang code>
(Instant AP) (osu-provider <name>) # frnd-name2 <OSU Friendly name>
(Instant AP) (osu-provider <name>) # frnd-name2-hex <OSU Friendly name>
(Instant AP) (osu-provider <name>) # iconfile-count <count>
(Instant AP) (osu-provider <name>) # icon1-width <width>
(Instant AP) (osu-provider <name>) # icon1-height <height>
(Instant AP) (osu-provider <name>) # icon1-lang-code <lang code>
(Instant AP) (osu-provider <name>) # icon1-type <file type>
(Instant AP) (osu-provider <name>) # icon1-file <idx> <File Name>
(Instant AP) (osu-provider <name>) # icon2-width <width>
(Instant AP) (osu-provider <name>) # icon2-height <height>
(Instant AP) (osu-provider <name>) # icon2-lang-code <lang code>
(Instant AP) (osu-provider <name>) # icon2-type <file type>
(Instant AP) (osu-provider <name>) # icon2-file <idx> <File Name>
(Instant AP) (osu-provider <name>) # srvcdesc-count <count>
(Instant AP) (osu-provider <name>) # srvc-desc1-lang-code <lang code>
(Instant AP) (osu-provider <name>) # srvc-desc1 <description>
(Instant AP) (osu-provider <name>) # srvc-desc1-hex <description>
(Instant AP) (osu-provider <name>) # srvc-desc2-lang-code <lang code>
(Instant AP) (osu-provider <name>) # srvc-desc2 <description>
(Instant AP) (osu-provider <name>) # srvc-desc2-hex <description>
(Instant AP) (osu-provider <name>) # osu-server-uri <OSU server URI>
```

(Instant AP) (osu-provider <name>) # osu-method <OSU method>

Table 126: HS2 OSU Provider Parameters

Parameter	Description	Range
enable	Enables the OSU provider profile. This is enabled by default.	—
frnd-name-count	Number of OSU friendly names to be configured.	1-2
frnd-name1	The first OSU friendly name if you selected the language code as English. A string value of maximum 64 characters.	—
frnd-name1-hex	The first OSU friendly name in hexadecimal format for language codes other than English.	—
frnd-name1-lang-code	The language code used for configuring the first OSU friendly name.	—
frnd-name2	The second OSU friendly name if the language code chosen is English. A string value of maximum 64 characters.	—
frnd-name2-hex	The second OSU friendly name in hexadecimal format for language codes other than English.	—
frnd-name2-lang-code	The language code used for configuring the second OSU friendly name.	—
icon1-file	The index and name of the first icon image file. NOTE: The index value and the filename value must match the file downloaded to OAW-IAP. For more information on downloading the icon file, refer to Downloading Icon Files to OAW-IAP on page 495 .	—
icon1-height	Height of the first icon image file.	1-256
icon1-lang-code	Indicates the language used in the first icon image.	—
icon1-type	Type of the image file used as first icon.	—
icon1-width	Width of the first icon image file.	1-256
icon2-file	The index and name of the second icon image file. NOTE: The index value and the filename value must match the file downloaded to OAW-IAP. For more information on downloading the icon file, refer to Downloading Icon Files to OAW-IAP on page 495 .	—
icon2-height	Height of the second icon image file.	—
icon2-lang-code	Indicates the language used in the second icon image.	—
icon2-type	Type of the image file used as second icon.	—
icon2-width	Width of the second icon image file.	—

Table 126: HS2 OSU Provider Parameters

Parameter	Description	Range
iconfile-count	Number of icon files to be used for the OSU provider.	1-2
no	Deletes the command.	—
osu-method	Indicates the method used by OSU to provision the HS2 client.	<ul style="list-style-type: none"> ■ OMA-DM ■ SOAP-XML
osu-server-uri	The URI of the OSU Server that is used for OSU with the service provider configured in the frnd-name1 parameter.	—
svrc-desc1	The first service description if you selected the language code as English.	—
svrc-desc1-hex	The first service description in hexadecimal format for language codes other than English.	—
svrc-desc1-lang-code	The language code used for the first description.	—
svrc-desc2	The second service description if you selected the language code as English.	—
svrc-desc2-hex	The second service description in hexadecimal format for language codes other than English.	—
svrc-desc2-lang-code	The second service description if you selected the language code as English.	—
svrcdesc-count	Number of descriptions to be provided for the OSU provider.	—

Creating a Hotspot Profile

To create a hotspot profile:

```
(Instant AP) (config)# hotspot hs-profile <name>
(Instant AP) (Hotspot2.0 <name>)# asra
(Instant AP) (Hotspot2.0 <name>)# access-network-type <type>
(Instant AP) (Hotspot2.0 <name>)# addtl-roam-cons-ois <roam-consortium-OIs>
(Instant AP) (Hotspot2.0 <name>)# comeback-mode
(Instant AP) (Hotspot2.0 <name>)# gas-comeback <delay-interval>
(Instant AP) (Hotspot2.0 <name>)# group-frame-block
(Instant AP) (Hotspot2.0 <name>)# hessid <hotspot-essid>
(Instant AP) (Hotspot2.0 <name>)# internet
(Instant AP) (Hotspot2.0 <name>)# osu-nai <osu-nai>
(Instant AP) (Hotspot2.0 <name>)# osu-ssid <ssid>
(Instant AP) (Hotspot2.0 <name>)# p2p-cross-connect
(Instant AP) (Hotspot2.0 <name>)# p2p-dev-mgmt
(Instant AP) (Hotspot2.0 <name>)# pame-bi
(Instant AP) (Hotspot2.0 <name>)# qos-map-excp
(Instant AP) (Hotspot2.0 <name>)# qos-map-range
(Instant AP) (Hotspot2.0 <name>)# query-response-length-limit <integer>
(Instant AP) (Hotspot2.0 <name>)# roam-cons-len-1 <integer>
(Instant AP) (Hotspot2.0 <name>)# roam-cons-len-2 <integer>
(Instant AP) (Hotspot2.0 <name>)# roam-cons-len-3 <integer>
(Instant AP) (Hotspot2.0 <name>)# roam-cons-oi-1 <integer>
(Instant AP) (Hotspot2.0 <name>)# roam-cons-oi-2 <integer>
(Instant AP) (Hotspot2.0 <name>)# roam-cons-oi-3 <integer>
(Instant AP) (Hotspot2.0 <name>)# venue-group <group>
```

```
(Instant AP) (Hotspot2.0 <name>)# venue-type <type>
(Instant AP) (Hotspot2.0 <name>)# enable
```

OSU ESS can either be open or encrypted. When OSU ESS is using open encryption, create an SSID profile with the same name as provided in the hotspot profile and set the operation mode to open. When OSU ESS is encrypted, create a hotspot profile with only **osen** enabled and attach it to an SSID that broadcasts OSEN capable network. In this case, choose the operation mode to WPA2-AES.

To configure Online Sign-Up SSID in Encryption mode (OSEN), create a separate hotspot profile to enable OSEN and attach it to the SSID that broadcasts OSEN capable network:

```
(Instant AP) (config)# hotspot hs-profile <name>
(Instant AP) (Hotspot2.0 <name>)# osen
```



Ensure that all parameters except OSEN are disabled in the separate hotspot profile created for OSEN.

The hotspot profile configuration parameters are described in the following table:

Table 127: Hotspot Profile Configuration Parameters

Parameter	Description	Range	Default
access-network-type <type>	<p>Configures any of the following access network (802.11u network type) type:</p> <ul style="list-style-type: none"> ■ private—This network is accessible for authorized users only. For example, home networks or enterprise networks that require user authentication. The corresponding integer value for this network type is 0. ■ private-with-guest—This network is accessible to guest users based on guest authentication methods. For example, enterprise networks that allow guest users with captive portal authentication. The corresponding integer value for this network type is 1. ■ chargeable-public— This network provides access to the Internet based on payment. For example, a subscription-based Internet access in a coffee shop or a hotel offering chargeable in-room Internet access service. The corresponding integer value for this network type is 2. ■ free-public—This network is accessible to all without any charges applied. For example, a hotspot in airport or other public places that provide Internet access with no additional cost. The corresponding integer value for this network type is 3. ■ personal-device—This network is accessible for personal devices. For example, a laptop or camera configured with a printer for the purpose of printing. The corresponding integer value for this network type is 4. ■ emergency-services—This network is limited to accessing emergency services only. The corresponding 	private, private-with-guest, chargeable-public, free-public, personal-device, emergency-services, test, wildcard	chargeable-public

Table 127: Hotspot Profile Configuration Parameters

Parameter	Description	Range	Default
	<p>integer value for this network type is 5.</p> <ul style="list-style-type: none"> ■ test—This network is used for test purposes only. The corresponding integer value for this network type is 14. ■ wildcard—This network indicates a wildcard network. The corresponding integer value for this network type is 15. 		
addtl-roam-cons-ois <addtl-roam-cons-ois>	Configures the number of additional roaming consortium OIs advertised by the OAW-IAP. This feature supports up to three additional OIs, which are defined using the roam-cons-oi-1, roam-cons-oi-2 and roam-cons-oi-3 parameters.	—	—
advertisement-profile	<p>Associates an advertisement profile with the hotspot profile.</p> <p>You can associate any of the following advertisement profiles:</p> <ul style="list-style-type: none"> ■ anqp-3gpp-profile ■ anqp-domain-name-profile ■ anqp-ip-addr--profile ■ anqp-nai-realm-profile ■ anqp-nwk-auth-profile ■ anqp-roam-cons-profile ■ anqp-venue-name-profile ■ h2qp-conn-cap-profile ■ h2qp-oper-class-profile ■ h2qp-osu-provider-profile ■ h2qp-oper-name-profile ■ h2qp-wan-metrics-profile 	—	—
<profile-name>	Allows you to associate a specific advertisement profile to the hotspot profile.	—	—
asra	Indicates if any additional steps are required for network access.	—	—
comeback-mode	By default, ANQP information is obtained from a GAS Request and Response. If you enable the comeback-mode option, advertisement information is obtained using a GAS Request and Response, as well as a Comeback-Request and Comeback-Response. This option is disabled by default.	—	—
enable	Enables the hotspot profile.	—	—
gas-comeback-delay <delay>	Configures a GAS comeback delay interval after which the client can attempt to retrieve the query response using a Comeback Request Action frame.	100—2000 milliseconds	100

Table 127: Hotspot Profile Configuration Parameters

Parameter	Description	Range	Default
group-frame-block	Configures the DGAF Disabled Mode. This feature ensures that the OAW-IAP does not forward downstream group-addressed frames. It is disabled by default, allowing the OAW-IAP to forward downstream group-addressed frames.	—	—
hessid	Configures a homogenous ESS identifier.	MAC address in colon-separated hexadecimal format	—
internet	Allows the OAW-IAP to send an Information Element indicating that the network allows the Internet access. By default, a hotspot profile does not advertise network internet access.	—	—
no	Removes any existing configuration.	—	—
osen	Uses the OSEN information element to advertise and select an OSEN capable network. NOTE: You must create a separate hotspot profile only with OSEN enabled and attach it to the Online Sign-UP (OSU) SSID profile. Ensure that all the other parameters of the OSEN hotspot profile are disabled.	—	Disabled
osu-nai	Indicates the Network Access Identifier (NAI) that is used for OSU with the service provider configured in the OSU provider profile. When the OSU NAI is configured, the OSU ESS employs a link-layer encryption. For open OSU ESS, this parameter is not applicable.	—	—
osu-ssid	Configures the SSID that the wireless devices use for OSU with all the OSU providers.	—	—
p2p-cross-connect	Advertises support for P2P Cross Connections.	—	Disabled
p2p-dev-mgmt	Advertises support for P2P device management.	—	Disabled
pame-bi	Enables the PAME-BI bit, which is used by anOAW-IAP to indicate whether the OAW-IAP indicates that the Advertisement Server can return a query response that is independent of the BSSID used for the GAS Frame exchange.	—	—

Table 127: Hotspot Profile Configuration Parameters

Parameter	Description	Range	Default
qos-map-excp	Includes the DSCP exceptions in the QoS map set. You can configure a maximum of 21 sets of DSCP exception fields. It must be entered in Hexadecimal format. It is in the format, <value>-<up> separated by ',' where <value> can be 0-3F or FF, and user priority <up> can be 0-7).	—	—
qos-map-range	Configures the DSCP range value between 0 and 63 inclusive, or 255. It must be entered in Hexadecimal format. You must configure 8 sets each corresponding to a user priority. The format is <low>-<high> separated by a ',' where low and high are 0-3F and FF. For Example: 08-0F,00-07,FF-FF,10-1F,20-27,FF-FF,28-2F,30-3F	—	—
query-response-length-limit <len>	Configures the maximum length of the GAS query response. GAS enables advertisement services that allow the clients to query multiple 802.11 networks at once, while also allowing the client to learn more about a network's 802.11 infrastructure before associating. If a client transmits a GAS Query using a GAS Initial Request frame, the responding OAW-IAP will provide the query response (or information on how to receive the query response) in a GAS Initial Response frame.	1-6	1
release-number	Indicates the release number of Hotspot.	1-2	1
roam-cons-len-1	Configures the length of the OI. The value of the roam-cons-len-1 parameter is based upon the number of octets of the roam-cons-oi-1 field.	0: Zero Octets in the OI (Null), 3: OI length is 24-bit (3 Octets), 5: OI length is 36-bit (5 Octets)	—
roam-cons-len-2	Length of the OI. The value of the roam-cons-len-2 parameter is based upon the number of octets of the roam-cons-oi-2 field.	0: Zero Octets in the OI (Null), 3: OI length is 24-bit (3 Octets), 5: OI length is 36-bit (5 Octets)	—
roam-cons-len-3	Length of the OI. The value of the roam-cons-len-3 parameter is based upon the number of octets of the roam-cons-oi-3 field.	0: Zero Octets in the OI (Null), 3: OI length is 24-bit (3 Octets), 5: OI length is 36-bit (5 Octets)	—

Table 127: Hotspot Profile Configuration Parameters

Parameter	Description	Range	Default
roam-cons-oi-1 roam-cons-oi-2 roam-cons-oi-3	Configures the roaming consortium OI to assign to one of the service provider's top three roaming partners. This additional OI will only be sent to a client if the addtl-roam-cons-<oisaddtl-roam-cons-ois> parameter is set to 1 or higher. NOTE: The service provider's own roaming consortium OI is configured using the hotspot anqp-roam-cons-profile command.	—	—
venue-group <venue-group>	Configures one of the following venue groups to be advertised in the IEs from OAW-IAPs associated with this hotspot profile. <ul style="list-style-type: none"> ■ assembly ■ business ■ educational ■ factory-and-industrial ■ institutional ■ mercantile ■ outdoor ■ residential ■ storage ■ unspecified ■ utility-and-misc ■ vehicular NOTE: This parameter only defines the venue group advertised in the IEs from hotspot OAW-IAPs. To define the venue group to be included in ANQP responses, use anqp-venue-name-profile <profile-name> command.	assembly, business, educational, factory-and-industrial, institutional, mercantile, outdoor, residential, storage, unspecified, utility-and-misc, vehicular	business
venue-type <venue-type>	Specifies the venue type to be advertised in the IEs from OAW-IAPs associated with this hotspot profile. The complete list of supported venue types is described in Creating a Hotspot Profile on page 497 This parameter only defines the venue type advertised in the IEs from hotspot OAW-IAPs. To define the venue type to be included in ANQP responses, use the hotspot anqp-venue-name-profile <profile-name> command.	—	—

Associating an Advertisement Profile to a Hotspot Profile

To associate a hotspot profile with an advertisement profile:

```
(Instant AP) (config)# hotspot hs-profile <name>
(Instant AP) (Hotspot2.0 <name>)# advertisement-protocol <protocol>
(Instant AP) (Hotspot2.0 <name>)# advertisement-profile anqp-3gpp <name>
(Instant AP) (Hotspot2.0 <name>)# advertisement-profile anqp-domain-name <name>
(Instant AP) (Hotspot2.0 <name>)# advertisement-profile anqp-ip-addr-avail <name>
(Instant AP) (Hotspot2.0 <name>)# advertisement-profile anqp-nai-realm <name>
(Instant AP) (Hotspot2.0 <name>)# advertisement-profile anqp-nwk-auth <name>
(Instant AP) (Hotspot2.0 <name>)# advertisement-profile anqp-roam-cons <name>
(Instant AP) (Hotspot2.0 <name>)# advertisement-profile anqp-venue-name <name>
(Instant AP) (Hotspot2.0 <name>)# advertisement-profile h2qp-conn-cap <name>
```

```
(Instant AP) (Hotspot2.0 <name>)# advertisement-profile h2qp-oper-class <name>
(Instant AP) (Hotspot2.0 <name>)# advertisement-profile h2qp-oper-name <name>
(Instant AP) (Hotspot2.0 <name>)# advertisement-profile h2qp-osu-provider <name>
```

The configuration parameters for associating an advertisement profile with a hotspot profile are described in the following table:

Table 128: Advertisement Profile Association Parameters

Parameter	Description
advertisement-profile	Specify the advertisement profile to associate with this hotspot profile. For information on advertisement profiles, see Creating Advertisement Profiles for Hotspot Configuration on page 489 .
advertisement-protocol	Specify the advertisement protocol type; for example, specify the ANQP as anqp .

Creating a WLAN SSID and Associating Hotspot Profile

To create a WLAN SSID with Enterprise Security and WPA-2 Encryption Settings:

```
(Instant AP) (config)# wlan ssid-profile <name>
(Instant AP) (SSID Profile <name>)# essid <ESSID-name>
(Instant AP) (SSID Profile <name>)# type {<Employee> | <Voice>| <Guest>}
(Instant AP) (SSID Profile <name>)# vlan <vlan-ID>
(Instant AP) (SSID Profile <name>)# set-vlan <attribute>{equals|not-equals|starts-with|ends-with|contains} <operator> <VLAN-ID>| value-of}
(Instant AP) (SSID Profile <name>)# opmode {wpa2-aes|wpa-tkip,wpa2-aes}
(Instant AP) (SSID Profile <name>)# blacklist
(Instant AP) (SSID Profile <name>)# mac-authentication
(Instant AP) (SSID Profile <name>)# l2-auth-failthrough
(Instant AP) (SSID Profile <name>)# termination
(Instant AP) (SSID Profile <name>)# external-server
(Instant AP) (SSID Profile <name>)# auth-server <server-name>
(Instant AP) (SSID Profile <name>)# server-load-balancing
(Instant AP) (SSID Profile <name>)# radius-accounting
(Instant AP) (SSID Profile <name>)# radius-accounting-mode {user-authentication| user-association}
(Instant AP) (SSID Profile <name>)# radius-interim-accounting-interval <minutes>
(Instant AP) (SSID Profile <name>)# radius-reauth-interval <minutes>
(Instant AP) (SSID Profile <name>)# set-role-by-ssid
```

Sample Configuration

Step 1: Creating ANQP and H2QP Advertisement Profiles

```
(Instant AP)# configure terminal
(Instant AP) (config)# hotspot anqp-nai-realm-profile nr1
(Instant AP) (nai-realm "nr1")# nai-realm-name name1
(Instant AP) (nai-realm "nr1")# nai-realm-encoding utf8
(Instant AP) (nai-realm "nr1")# nai-realm-eap-method eap-sim
(Instant AP) (nai-realm "nr1")# nai-realm-auth-id-1 non-eap-inner-auth
(Instant AP) (nai-realm "nr1")# nai-realm-auth-value-1 mschapv2
(Instant AP) (nai-realm "nr1")# nai-home-realm
(Instant AP) (nai-realm "nr1")# exit

(Instant AP) (config)# hotspot anqp-venue-name-profile vn1
(Instant AP) (venue-name "vn1")# venue-group business
(Instant AP) (venue-name "vn1")# venue-type research-and-dev-facility
(Instant AP) (venue-name "vn1")# venue-lang-code eng
(Instant AP) (venue-name "vn1")# venue-name VenueName
(Instant AP) (venue-name "vn1")# exit
```

```

(Instant AP) (config)# hotspot anqp-nwk-auth-profile nal
(Instant AP) (network-auth "nal")# nwk-auth-type accept-term-and-cond
(Instant AP) (network-auth "nal")# url www.nwkauth.com
(Instant AP) (network-auth "nal")# exit

(Instant AP) (config)# hotspot anqp-roam-cons-profile rc1
(Instant AP) (roaming-consortium "rc1")# roam-cons-oi-len 3
(Instant AP) (roaming-consortium "rc1")# roam-cons-oi 888888
(Instant AP) (roaming-consortium "rc1")# exit

(Instant AP) (config)# hotspot anqp-3gpp-profile 3g
(Instant AP) (3gpp "3g")# 3gpp-plmn1 40486
(Instant AP) (3gpp "3g")# exit

(Instant AP) (config)# hotspot anqp-ip-addr-avail-profile ip1
(Instant AP) (IP-addr-avail "ip1")# no ipv4-addr-avail
(Instant AP) (IP-addr-avail "ip1")# ipv6-addr-avail
(Instant AP) (IP-addr-avail "ip1")# exit

(Instant AP) (config)# hotspot anqp-domain-name-profile dn1
(Instant AP) (domain-name "dn1")# domain-name DomainName
(Instant AP) (domain-name "dn1")# exit

(Instant AP) (config)# hotspot h2qp-oper-name-profile on1
(Instant AP) (operator-friendly-name"on1")# op-lang-code eng
(Instant AP) (operator-friendly-name"on1")# op-fr-name OperatorFriendlyName
(Instant AP) (operator-friendly-name"on1")# exit

(Instant AP) (config) # hotspot h2qp-conn-cap-profile cc1
(Instant AP) (connection-capabilities "cc1")# esp-port
(Instant AP) (connection-capabilities "cc1")# icmp
(Instant AP) (connection-capabilities "cc1")# tcp-ftp
(Instant AP) (connection-capabilities "cc1")# tcp-http
(Instant AP) (connection-capabilities "cc1")# tcp-pptp-vpn
(Instant AP) (connection-capabilities "cc1")# tcp-ssh
(Instant AP) (connection-capabilities "cc1")# tcp-tls-vpn
(Instant AP) (connection-capabilities "cc1")# tcp-voip
(Instant AP) (connection-capabilities "cc1")# udp-ike2
(Instant AP) (connection-capabilities "cc1")# udp-ipsec-vpn
(Instant AP) (connection-capabilities "cc1")# udp-voip
(Instant AP) (connection-capabilities "cc1")# enable
(Instant AP) (connection-capabilities "cc1")# exit

(Instant AP) (config) # hotspot h2qp-oper-class-profile oc1
(Instant AP) (operator-class "oc1")# op-class <class-ID>
(Instant AP) (operator-class "oc1")# enable
(Instant AP) (operator-class "oc1")# exit

(Instant AP) (config) # hotspot h2qp-osu-provider-profile osu1
(Instant AP) (osu-provider "osu1") # frnd-name-count 2
(Instant AP) (osu-provider "osu1") # frnd-name1-lang-code "eng"
(Instant AP) (osu-provider "osu1") # frnd-name1 "SP Red Test Only"
(Instant AP) (osu-provider "osu1") # frnd-name1-hex
(Instant AP) (osu-provider "osu1") # frnd-name2-lang-code "kor"
(Instant AP) (osu-provider "osu1") # frnd-name2 ""
(Instant AP) (osu-provider "osu1") # frnd-name2-hex
535020ebb9a8eab09520ed858cec8aa4ed8ab820eca084ec9aa9
(Instant AP) (osu-provider "osu1") # iconfile-count 2
(Instant AP) (osu-provider "osu1") # icon1-width 128
(Instant AP) (osu-provider "osu1") # icon1-height 61
(Instant AP) (osu-provider "osu1") # icon1-lang-code zxx

```



```
(Instant AP) (osu-provider "osul") # icon1-type image/png
(Instant AP) (osu-provider "osul") # icon1-file 1 "icon_red_zxx.png"
(Instant AP) (osu-provider "osul") # icon2-width 160
(Instant AP) (osu-provider "osul") # icon2-height 76
(Instant AP) (osu-provider "osul") # icon2-lang-code eng
(Instant AP) (osu-provider "osul") # icon2-type image/png
(Instant AP) (osu-provider "osul") # icon2-file 2 "icon_red_eng.png"
(Instant AP) (osu-provider "osul") # srvcdesc-count 2
(Instant AP) (osu-provider "osul") # srvc-desc1-lang-code eng
(Instant AP) (osu-provider "osul") # srvc-desc1 "Free service for test purpose"
(Instant AP) (osu-provider "osul") # srvc-desc1-hex
(Instant AP) (osu-provider "osul") # srvc-desc2-lang-code kor
(Instant AP) (osu-provider "osul") # srvc-desc2 ""
(Instant AP) (osu-provider "osul") # srvc-desc2-hex
ed858cec8aa4ed8ab820ebaaa9eca081ec9cbceba19c20ebacb4eba38c20ec849cebb984ec8aa4
(Instant AP) (osu-provider "osul") # osu-server-uri https://osu-server.r2-testbed-ar.wi-
fi.org:443/guest/HotSpot2OnlineSignUp.php
(Instant AP) (osu-provider "osul") # osu-method SOAP-XML
(Instant AP) (WAN-metrics "osul") # exit
```

```
(Instant AP) (config)# hotspot h2qp-wan-metrics-profile wml
(Instant AP) (WAN-metrics "wml") # at-capacity
(Instant AP) (WAN-metrics "wml") # downlink-load <load>
(Instant AP) (WAN-metrics "wml") # downlink-speed <speed>
(Instant AP) (WAN-metrics "wml") # load-duration <duration>
(Instant AP) (WAN-metrics "wml") # symm-link
(Instant AP) (WAN-metrics "wml") # uplink-load <load>
(Instant AP) (WAN-metrics "wml") # uplink-speed <speed>
(Instant AP) (WAN-metrics "wml") # wan-metrics-link-status <status>
(Instant AP) (WAN-metrics "wml") # exit
```

Step 2: Creating a hotspot profile

```
(Instant AP) # configure terminal
(Instant AP) (config)# hotspot hs-profile hs1
(Instant AP) (Hotspot2.0 "hs1") # enable
(Instant AP) (Hotspot2.0 "hs1") # comeback-mode
(Instant AP) (Hotspot2.0 "hs1") # gas-comeback-delay 100
(Instant AP) (Hotspot2.0 "hs1") # no asra
(Instant AP) (Hotspot2.0 "hs1") # no internet
(Instant AP) (Hotspot2.0 "hs1") # osu-ssid OSU-SSID
(Instant AP) (Hotspot2.0 "hs1") # qos-map-excp 35-2,16-6
(Instant AP) (Hotspot2.0 "hs1") # qos-map-range 08-0F,00-07,FF-FF,10-1F,20-27,FF-FF,28-2F,30-3F
(Instant AP) (Hotspot2.0 "hs1") # query-response-length-limit 2
(Instant AP) (Hotspot2.0 "hs1") # access-network-type chargeable-public
(Instant AP) (Hotspot2.0 "hs1") # roam-cons-len-1 3
(Instant AP) (Hotspot2.0 "hs1") # roam-cons-oi-1 123456
(Instant AP) (Hotspot2.0 "hs1") # roam-cons-len-2 3
(Instant AP) (Hotspot2.0 "hs1") # roam-cons-oi-2 223355
(Instant AP) (Hotspot2.0 "hs1") # addtl-roam-cons-ois 0
(Instant AP) (Hotspot2.0 "hs1") # venue-group business
(Instant AP) (Hotspot2.0 "hs1") # venue-type research-and-dev-facility
(Instant AP) (Hotspot2.0 "hs1") # pame-bi
(Instant AP) (Hotspot2.0 "hs1") # group-frame-block
(Instant AP) (Hotspot2.0 "hs1") # p2p-dev-mgmt
(Instant AP) (Hotspot2.0 "hs1") # p2p-cross-connect
```

Step 3 (Optional): Creating a hotspot profile for OSEN

```
(Instant AP) (config) # hotspot hs-profile hs2
(Instant AP) (Hotspot2.0 "hs2") # osen
(Instant AP) (Hotspot2.0 "hs2") # no enable
```

Step 4: Associating advertisement profiles with the hotspot profile

```

(Instant AP)# configure terminal
(Instant AP)(config)# hotspot hs-profile hs1
(Instant AP)(Hotspot2.0 "hs1")# advertisement-profile anqp-nai-realm-profile nr1
(Instant AP)(Hotspot2.0 "hs1")# advertisement-profile anqp-venue-name-profile vn1
(Instant AP)(Hotspot2.0 "hs1")# advertisement-profile anqp-nwk-auth-profile na1
(Instant AP)(Hotspot2.0 "hs1")# advertisement-profile anqp-roam-cons-profile rc1
(Instant AP)(Hotspot2.0 "hs1")# advertisement-profile anqp-3gpp-profile 3g1
(Instant AP)(Hotspot2.0 "hs1")# advertisement-profile anqp-ip-addr-avail-profile ip1
(Instant AP)(Hotspot2.0 "hs1")# advertisement-profile anqp-domain-name-profile dn1
(Instant AP)(Hotspot2.0 "hs1")# advertisement-profile h2qp-oper-name-profile on1
(Instant AP)(Hotspot2.0 "hs1")# advertisement-profile h2qp-wan-metrics-profile wm1
(Instant AP)(Hotspot2.0 "hs1")# advertisement-profile h2qp-conn-cap-profile cc1
(Instant AP)(Hotspot2.0 "hs1")# advertisement-profile h2qp-oper-class-profile oc1
(Instant AP)(Hotspot2.0 "hs1")# advertisement-profile h2qp-osu-provider-profile osu1

```

Step 5: Associating the hotspot profile with production WLAN SSID:

```

(Instant AP)# configure terminal
(Instant AP)# wlan ssid-profile ssidProfile1
(Instant AP)(SSID Profile "ssidProfile1")# essid hsProf
(Instant AP)(SSID Profile "ssidProfile1")# type employee
(Instant AP)(SSID Profile "ssidProfile1")# vlan 200
(Instant AP)(SSID Profile "ssidProfile1")# opmode wpa2-aes
(Instant AP)(SSID Profile "ssidProfile1")# auth-server RADIUS1
(Instant AP)(SSID Profile "ssidProfile1")# hotspot-profile hs1

```

Step 6 (Only if Step 3 is configured): Associating OSEN hotspot profile with an SSID that broadcasts OSEN capable network:

```

(Instant AP)# configure terminal
(Instant AP)# wlan ssid-profile OSU-SSID
(Instant AP)(SSID Profile "OSU-SSID")# hotspot-profile hs2

```

OSU ESS can either be open or encrypted. When OSU ESS is using open encryption, create an SSID profile with the same name as provided in the hotspot profile and set the operation mode to open. When OSU ESS is encrypted, create a hotspot profile with only **osen** enabled and attach it to an SSID that broadcasts OSEN capable network. In this case, choose the operation mode to WPA2-AES.



This chapter consists of the following topics:

- [Configuring ClearPass Guest on page 507](#)
- [Verifying ClearPass Guest Setup on page 510](#)
- [Troubleshooting on page 511](#)

Configuring ClearPass Guest

1. From the ClearPass Guest WebUI, navigate to **Administration > AirGroup Services**.
2. Click **Configure AirGroup Services**.

Figure 34 *Configure AirGroup Services*

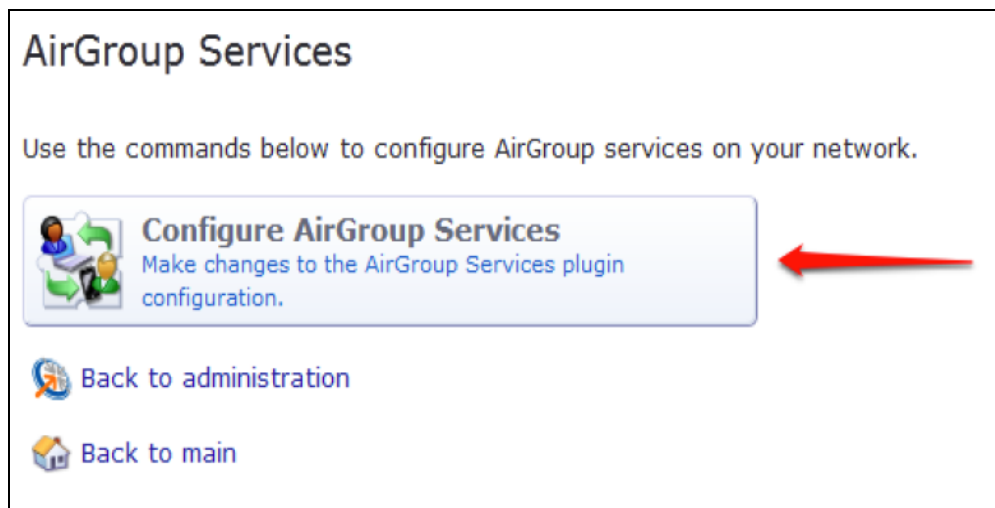

3. Click **Add a new controller**.
4. Update the parameters with appropriate values.



Ensure that the port configured matches the CoA port ([RFC 3576](#)) set on the OAW-IAP configuration.

5. Click **Save Configuration**.

In order to demonstrate AirGroup, either an AirGroup Administrator or an AirGroup Operator account must be created.

Creating AirGroup Administrator and Operator Account

To create a AirGroup administrator and AirGroup operator account using the ClearPass Policy Manager UI:

1. Navigate to the ClearPass Policy Manager WebUI, and navigate to **Configuration > Identity > Local Users**.

Figure 35 Configuration > Identity > Local Users Selection

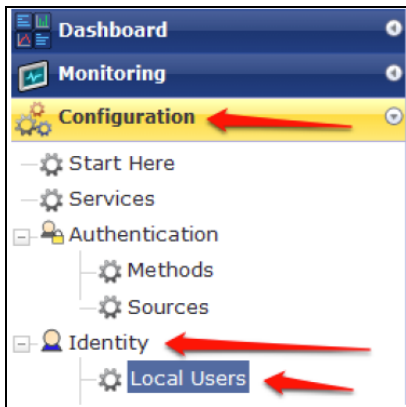

2. Click **Add User**.
3. Create an **AirGroup Administrator** by entering the required values.

Figure 36 Create an AirGroup Administrator

A screenshot of the 'Add Local User' form. The form contains the following fields:

- User ID: airgroup-admin
- Name: AirGroup Admin
- Password: [masked]
- Verify Password: [masked]
- Enable User: (Check to enable local user)
- Role: [AirGroup Administrator] (indicated by a red arrow)

Below the fields is an 'Attributes' section with a table header 'Attribute' and 'Value'. The table contains one row: '1. Click to add...'. At the bottom right are 'Add' and 'Cancel' buttons.

4. Click **Add**.
5. Now click **Add User** to create an **AirGroup Operator**.

Figure 37 Create an AirGroup Operator

Add Local User

User ID: aigroup-oper

Name: AirGroup Operator

Password: [Masked]

Verify Password: [Masked]

Enable User: (Check to enable local user)

Role: [AirGroup Operator]

Attributes

Attribute	Value
1. Click to add...	

Add Cancel

6. Click **Add** to save the user with an **AirGroup Operator** role. The **AirGroup Administrator** and **AirGroup Operator IDs** will be displayed in the **Local Users** UI screen.

Figure 38 Local Users UI Screen

ClearPass Policy Manager

Configuration » Identity » Local Users

Local Users

User deleted successfully

Filter: User ID contains [] Go Clear Filter Show 10 records

#	User ID	Name	Role	Status
1.	airgroup-admin	AirGroup Admin	[AirGroup Administrator]	Enabled
2.	airgroup-oper	AirGroup Operator	[AirGroup Operator]	Enabled
3.	test	test	TestRole	Enabled

Showing 1-3 of 3

Export Delete

7. Navigate to the ClearPass Guest UI and click **Logout**. The **ClearPass Guest Login** page is displayed. Use the AirGroup admin credentials to log in.

8. After logging in, click **Create Device**.

Figure 39 Create a Device



The **Register Shared Device** page is displayed.

Figure 40 ClearPass Guest- Register Shared Device

Register Shared Device	
* Device Name:	<input type="text"/> Enter a name to identify the device.
* MAC Address:	<input type="text"/> Enter the MAC address of the device.
Shared Locations:	<input type="text"/> Enter a list of location IDs where this device will be shared. Use a comma-separated list of tag=value pairs; tag may be AP-Name, AP-Group, or FQLN. A fully qualified location name is ` <code><ap-name>.floor<N>.<building-name>.<campus></code> `. Leave blank to share with all locations.
Shared With:	<input type="text"/> Enter up to 10 usernames that will be able to use this device. Use a comma-separated list, e.g. user1,user2,user3, or blank for all users.
Shared Roles:	<input type="text"/> List the user roles that will be able to use this device. Use a comma-separated list, e.g. role1,role2,role3, or blank for all roles.
<input type="button" value="Register Shared Device"/>	

For this test, add your AppleTV device name and MAC address but leave all other boxes empty.

9. Click **Register Shared Device**.

Verifying ClearPass Guest Setup

1. Disconnect your AppleTV and OSX Mountain Lion or iOS 6 devices if they were previously connected to the wireless network. Remove their entries from the switch's user table using these commands:
 - Find the MAC address—**show user table**
 - Delete the address from the table—**aaa user delete mac 00:aa:22:bb:33:cc**
2. Reconnect both devices. To limit access to the AppleTV, access the ClearPass Guest UI using either the AirGroup admin or the AirGroup operator credentials. Next, navigate to **List Devices > Test Apple TV > Edit**. Add a username that is not used to log in to the Apple devices in the **Shared With** box.
3. Disconnect and remove the OSX Mountain Lion or iOS 6 device from the switch's user table. Reconnect the device by not using the username that you added to the **Shared With** box. The AppleTV should not be available to this device.

4. Disconnect the OSX Mountain Lion or iOS 6 device and delete it from the switch's user table. Reconnect using the username that was added to the **Shared With** box. The OSX Mountain Lion or iOS 6 device should once again have access to the AppleTV.

Troubleshooting

Table 129: *Troubleshooting*

Problem	Solution
Limiting devices has no effect.	Ensure IPv6 is disabled.
Apple Macintosh running Mountain Lion can use AirPlay but iOS devices cannot.	Ensure IPv6 is disabled.

The following table provides a brief description of the terminology used in this guide.

3DES

Triple Data Encryption Standard. 3DES is a symmetric-key block cipher that applies the DES cipher algorithm three times to each data block.

3G

Third Generation of Wireless Mobile Telecommunications Technology. See W-CDMA.

3GPP

Third Generation Partnership Project. 3GPP is a collaborative project aimed at developing globally acceptable specifications for third generation mobile systems.

4G

Fourth Generation of Wireless Mobile Telecommunications Technology. See LTE.

802.11

802.11 is an evolving family of specifications for wireless LANs developed by a working group of the Institute of Electrical and Electronics Engineers (IEEE). 802.11 standards use the Ethernet protocol and Carrier Sense Multiple Access with collision avoidance (CSMA/CA) for path sharing.

802.11 bSec

802.11 bSec is an alternative to 802.11i. The difference between bSec and standard 802.11i is that bSec implements Suite B algorithms wherever possible. Notably, Advanced Encryption Standard-Counter with CBC-MAC is replaced by Advanced Encryption Standard - Galois/Counter Mode, and the Key Derivation Function (KDF) of 802.11i is upgraded to support SHA-256 and SHA-384.

802.11a

802.11a provides specifications for wireless systems. Networks using 802.11a operate at radio frequencies in the 5 GHz band. The specification uses a modulation scheme known as orthogonal frequency-division multiplexing (OFDM) that is especially well suited to use in office settings. The maximum data transfer rate is 54 Mbps.

802.11ac

802.11ac is a wireless networking standard in the 802.11 family that provides high-throughput WLANs on the 5 GHz band.

802.11b

802.11b is a WLAN standard often called Wi-Fi and is backward compatible with 802.11. Instead of the Phase-Shift Keying (PSK) modulation method used in 802.11 standards, 802.11b uses Complementary Code Keying (CCK) that allows higher data speeds and makes it less susceptible to multipath-propagation interference. 802.11b operates in the 2.4 GHz band and the maximum data transfer rate is 11 Mbps.

802.11d

802.11d is a wireless network communications specification for use in countries where systems using other standards in the 802.11 family are not allowed to operate. Configuration can be fine-tuned at the Media Access Control (MAC) layer level to comply with the rules of the country or district in which the network is to be used. Rules are subject to variation and include allowed frequencies, allowed power levels, and allowed signal bandwidth. 802.11d facilitates global roaming.

802.11e

802.11e is an enhancement to the 802.11a and 802.11b specifications that enhances the 802.11 Media Access Control layer with a coordinated Time Division Multiple Access (TDMA) construct. It adds error-correcting mechanisms for delay-sensitive applications such as voice and video. The 802.11e specification provides seamless interoperability between business, home, and public environments such as airports and hotels, and offers all subscribers high-speed Internet access with full-motion video, high-fidelity audio, and VoIP.

802.11g

802.11g offers transmission over relatively short distances at up to 54 Mbps, compared with the 11 Mbps theoretical maximum of 802.11b standard. 802.11g employs Orthogonal Frequency Division Multiplexing (OFDM), the modulation scheme used in 802.11a, to obtain higher data speed. Computers or terminals set up for 802.11g can fall back to speed of 11 Mbps, so that 802.11b and 802.11g devices can be compatible within a single network.

802.11h

802.11h is intended to resolve interference issues introduced by the use of 802.11a in some locations, particularly with military Radar systems and medical devices. Dynamic Frequency Selection (DFS) detects the presence of other devices on a channel and automatically switches the network to another channel if and when such signals are detected. Transmit Power Control (TPC) reduces the radio frequency (RF) output power of each network transmitter to a level that minimizes the risk of interference.

802.11i

802.11i provides improved encryption for networks that use 802.11a, 802.11b, and 802.11g standards. It requires new encryption key protocols, known as Temporal Key Integrity Protocol (TKIP) and Advanced Encryption Standard (AES).

802.11j

802.11j is a proposed addition to the 802.11 family of standards that incorporates Japanese regulatory extensions to 802.11a; the main intent is to add channels in the radio frequency (RF) band of 4.9 GHz to 5.0 GHz.

802.11k

802.11k is an IEEE standard that enables APs and client devices to discover the best available radio resources for seamless BSS transition in a WLAN.

802.11m

802.11m is an Initiative to perform editorial maintenance, corrections, improvements, clarifications, and interpretations relevant to documentation for 802.11 family specifications.

802.11n

802.11n is a wireless networking standard to improve network throughput over the two previous standards, 802.11a and 802.11g. With 802.11n, there will be a significant increase in the maximum raw data rate from 54 Mbps to 600 Mbps with the use of four spatial streams at a channel width of 40 MHz.

802.11r

802.11r is an IEEE standard for enabling seamless BSS transitions in a WLAN. 802.11r standard is also referred to as Fast BSS transition.

802.11u

802.11u is an amendment to the IEEE 802.11 WLAN standards for connection to external networks using common wireless devices such as smartphones and tablet PCs. The 802.11u protocol provides wireless clients with a streamlined mechanism to discover and authenticate to suitable networks, and allows mobile users to roam between partner networks without additional authentication. An 802.11u-capable device supports the Passpoint technology from the Wi-Fi Alliance Hotspot 2.0 R2 Specification that simplifies and automates access to public Wi-Fi.

802.11v

802.11v is an IEEE standard that allows client devices to exchange information about the network topology and RF environment. This information is used for assigning best available radio resources for the client devices to provide seamless connectivity.

802.1Q

802.1Q is an IEEE standard that enables the use of VLANs on an Ethernet network. 802.1Q supports VLAN tagging.

802.1X

802.1X is an IEEE standard for port-based network access control designed to enhance 802.11 WLAN security. 802.1X provides an authentication framework that allows a user to be authenticated by a central authority.

802.3af

802.3af is an IEEE standard for Power over Ethernet (PoE) version that supplies up to 15.4W of DC power. See PoE.

802.3at

802.3at is an IEEE standard for PoE version that supplies up to 25.5W of DC power. See PoE+.

A-MPDU

Aggregate MAC Protocol Data Unit. A-MPDU is a method of frame aggregation, where several MPDUs are combined into a single frame for transmission.

A-MSDU

Aggregate MAC Service Data Unit. A-MSDU is a structure containing multiple MSDUs, transported within a single (unfragmented) data MAC MPDU.

AAA

Authentication, Authorization, and Accounting. AAA is a security framework to authenticate users, authorize the type of access based on user credentials, and record authentication events and information about the network access and network resource consumption.

ABR

Area Border Router. ABR is used for establishing connection between the backbone networks and the Open Shortest Path First (OSPF) areas. ABR is located near the border of one or more OSPF areas.

AC

Access Category. As per the IEEE 802.11e standards, AC refers to various levels of traffic prioritization in Enhanced Distributed Channel Access (EDCA) operation mode. The WLAN applications prioritize traffic based on the Background, Best Effort, Video, and Voice access categories. AC can also refer to Alternating Current, a form of electric energy that flows when the appliances are plugged to a wall socket.

ACC

Advanced Cellular Coexistence. The ACC feature in APs enable WLANs to perform at peak efficiency by minimizing interference from 3G/4G/LTE networks, distributed antenna systems, and commercial small cell/femtocell equipment.

Access-Accept

Response from the RADIUS server indicating successful authentication and containing authorization information.

Access-Reject

Response from RADIUS server indicating that a user is not authorized.

Access-Request

RADIUS packet sent to a RADIUS server requesting authorization.

Accounting-Request

RADIUS packet type sent to a RADIUS server containing accounting summary information.

Accounting-Response

RADIUS packet sent by the RADIUS server to acknowledge receipt of an Accounting-Request.

ACE

Access Control Entry. ACE is an element in an ACL that includes access control information.

ACI

Adjacent Channel Interference. ACI refers to interference or interruptions detected on a broadcasting channel, caused by too much power on an adjacent channel in the spectrum.

ACL

Access Control List. ACL is a common way of restricting certain types of traffic on a physical port.

Active Directory

Microsoft Active Directory. The directory server that stores information about a variety of things, such as organizations, sites, systems, users, shares, and other network objects or components. It also provides authentication and authorization mechanisms, and a framework within which related services can be deployed.

ActiveSync

Mobile data synchronization app developed by Microsoft that allows a mobile device to be synchronized with either a desktop or a server running compatible software products.

ad hoc network

An ad hoc network is a network composed of individual devices communicating with each other directly. Many ad hoc networks are Local Area Networks (LANs) where computers or other devices are enabled to send data directly to one another rather than going through a centralized access point.

ADO

Active X Data Objects is a part of Microsoft Data Access Components (MDACs) that enables client applications to access data sources through an (Object Linking and Embedding Database) OLE DB provider. ADO supports key features for building client-server and Web-based applications.

ADP

Aruba Discovery Protocol. ADP is an Aruba proprietary Layer 2 protocol. It is used by the APs to obtain the IP address of the TFTP server from which it downloads the AP boot image.

AES

Advanced Encryption Standard. AES is an encryption standard used for encrypting and protecting electronic data. The AES encrypts and decrypts data in blocks of 128 bits (16 bytes), and can use keys of 128 bits, 192 bits, and 256 bits.

AIFSN

Arbitrary Inter-frame Space Number. AIFSN is set by the AP in beacon frames and probe responses. AIFS is a method of prioritizing a particular category of traffic over the other, for example prioritizing voice or video messages over email.

AirGroup

The application that allows the end users to register their personal mobile devices on a local network and define a group of friends or associates who are allowed to share them. AirGroup is primarily designed for colleges and other institutions. AirGroup uses zero configuration networking to allow Apple mobile devices, such as the AirPrint wireless printer service and the AirPlay mirroring service, to communicate over a complex access network topology.

AirWave Management Client

AirWave Management Client is a Windows software utility that enables client devices (such as a laptop) to act as passive RF sensors and augments the AirWave RAPIDS module.

ALE

Analytics and Location Engine. ALE gives visibility into everything the wireless network knows. This enables customers and partners to gain a wealth of information about the people on their premises. This can be very important for many different verticals and use cases. ALE includes a location engine that calculates associated and unassociated device location periodically using context streams, including RSSI readings, from WLAN controllers or Instant clusters.

ALG

Application Layer Gateway. ALG is a security component that manages application layer protocols such as SIP, FTP and so on.

AM

Air Monitor. AM is a mode of operation supported on wireless APs. When an AP operates in the Air Monitor mode, it enhances the wireless networks by collecting statistics, monitoring traffic, detecting intrusions, enforcing security policies, balancing wireless traffic load, self-healing coverage gaps, and more. However, clients cannot connect to APs operating in the AM mode.

AMON

Advanced Monitoring. AMON is used in Aruba WLAN deployments for improved network management, monitoring and diagnostic capabilities.

AMP

AirWave Management Platform. AMP is a network management system for configuring, monitoring, and upgrading wired and wireless devices on your network.

ANQP

Access Network Query Protocol. ANQP is a query and a response protocol for Wi-Fi hotspot services. ANQP includes information Elements (IEs) that can be sent from the AP to the client to identify the AP network and service provider. The IEs typically include information about the domain name of the AP operator, the IP addresses available at the AP, and information about potential roaming partners accessible through the AP. If the client responds with a request for a specific IE, the AP will send a Generic Advertisement Service (GAS) response frame with the configured ANQP IE information.

ANSI

American National Standards Institute. It refers to the ANSI compliance standards for products, systems, services, and processes.

API

Application Programming Interface. Refers to a set of functions, procedures, protocols, and tools that enable users to build application software.

app

Short form for application. It generally refers to the application that is downloaded and used on mobile devices.

ARM

Adaptive Radio Management. ARM dynamically monitors and adjusts the network to ensure that all users are allowed ready access. It enables full utilization of the available spectrum to support maximum number of users by intelligently choosing the best RF channel and transmit power for APs in their current RF environment.

ARP

Address Resolution Protocol. ARP is used for mapping IP network address to the hardware MAC address of a device.

Aruba Activate

Aruba Activate is a cloud-based service that helps provision your Aruba devices and maintain your inventory. Activate automates the provisioning process, allowing a single IT technician to easily and rapidly deploy devices throughout a distributed enterprise network.

ASCII

American Standard Code for Information Interchange. An ASCII code is a numerical representation of a character or an action.

B-RAS

Broadband Remote Access Server. A B-RAS is a server that facilitates and converges traffic from multiple Internet traffic resources such as cable, DSL, Ethernet, or Broadband wireless.

band

Band refers to a specified range of frequencies of electromagnetic radiation.

BGP

Border Gateway Protocol. BGP is a routing protocol for exchanging data and information between different host gateways or autonomous systems on the Internet.

BLE

Bluetooth Low Energy. The BLE functionality is offered by Bluetooth® to enable devices to run for long durations with low power consumption.

BMC

Beacon Management Console. BMC manages and monitors beacons from the BLE devices. The BLE devices are used for location tracking and proximity detection.

BPDU

Bridge Protocol Data Unit. A BPDU is a data message transmitted across a local area network to detect loops in network topologies.

BRE

Basic Regular Expression. The BRE syntax standards designed by the IEEE provides extension to the traditional Simple Regular Expressions syntax and allows consistency between utility programs such as grep, sed, and awk.

BSS

Basic Service Set. A BSS is a set of interconnected stations that can communicate with each other. BSS can be an independent BSS or infrastructure BSS. An independent BSS is an ad hoc network that does not include APs, whereas the infrastructure BSS consists of an AP and all its associated clients.

BSSID

Basic Service Set Identifier. The BSSID identifies a particular BSS within an area. In infrastructure BSS networks, the BSSID is the MAC address of the AP. In independent BSS or ad hoc networks, the BSSID is generated randomly.

BYOD

Bring Your Own Device. BYOD refers to the use of personal mobile devices within an enterprise network infrastructure.

CA

Certificate Authority or Certification Authority. Entity in a public key infrastructure system that issues certificates to clients. A certificate signing request received by the CA is converted into a certificate when the CA adds a signature generated with a private key. See digital certificate.

CAC

Call Admission Control. CAC regulates traffic volume in voice communications. CAC can also be used to ensure or maintain a certain level of audio quality in voice communications networks.

CALEA

Communications Assistance for Law Enforcement Act. To comply with the CALEA specifications and to allow lawful interception of Internet traffic by the law enforcement and intelligence agencies, the telecommunications carriers and manufacturers of telecommunications equipment are required to modify and design their equipment, facilities, and services to ensure that they have built-in surveillance capabilities.

Campus AP

Campus APs are used in private networks where APs connect over private links (LAN, WLAN, WAN or MPLS) and terminate directly on controllers. Campus APs are deployed as part of the indoor campus solution in enterprise office buildings, warehouses, hospitals, universities, and so on.

captive portal

A captive portal is a web page that allows the users to authenticate and sign in before connecting to a public-access network. Captive portals are typically used by business centers, airports, hotel lobbies, coffee shops, and other venues that offer free Wi-Fi hotspots for the guest users.

CCA

Clear Channel Assessment. In wireless networks, the CCA method detects if a channel is occupied or clear, and determines if the channel is available for data transmission.

CDP

Cisco Discovery Protocol. CDP is a proprietary Data Link Layer protocol developed by Cisco Systems. CDP runs on Cisco devices and enables networking applications to learn about the neighboring devices directly connected to the network.

CDR

Call Detail Record. A CDR contains the details of a telephone or VoIP call, such as the origin and destination addresses of the call, the start time and end time of the call, any toll charges that were added through the network or charges for operator services, and so on.

CEF

Common Event Format. The CEF is a standard for the interoperability of event or log-generating devices and applications. The standard syntax for CEF includes a prefix and a variable extension formatted as key-value pairs.

CGI

Common Gateway Interface. CGI is a standard protocol for exchanging data between the web servers and executable programs running on a server to dynamically process web pages.

CHAP

Challenge Handshake Authentication Protocol. CHAP is an authentication scheme used by PPP servers to validate the identity of remote clients.

CIDR

Classless Inter-Domain Routing. CIDR is an IP standard for creating and allocating unique identifiers for networks and devices. The CIDR IP addressing scheme is used as a replacement for the older IP addressing scheme based on classes A, B, and C. With CIDR, a single IP address can be used to designate many unique IP addresses. A CIDR IP address ends with a slash followed by the IP network prefix, for example, 192.0.2.0/24.

ClearPass

ClearPass is an access management system for creating and enforcing policies across a network to all devices and applications. The ClearPass integrated platform includes applications such as Policy Manager, Guest, Onboard, OnGuard, Insight, Profile, QuickConnect, and so on.

ClearPass Guest

ClearPass Guest is a configurable ClearPass application for secure visitor network access management.

ClearPass Policy Manager

ClearPass Policy Manager is a baseline platform for policy management, AAA, profiling, network access control, and reporting. With ClearPass Policy Manager, the network administrators can configure and manage secure network access that accommodates requirements across multiple locations and multivendor networks, regardless of device ownership and connection method.

CLI

Command-Line Interface. A console interface with a command line shell that allows users to execute text input as commands and convert these commands to appropriate functions.

CN

Common Name. CN is the primary name used to identify a certificate.

CNA

Captive Network Assistant. CNA is a popup page shown when joining a network that has a captive portal.

CoA

Change of Authorization. The RADIUS CoA is used in the AAA service framework to allow dynamic modification of the authenticated, authorized, and active subscriber sessions.

CoS

Class of Service. CoS is used in data and voice protocols for classifying packets into different types of traffic (voice, video, or data) and setting a service priority. For example, voice traffic can be assigned a higher priority over email or HTTP traffic.

CPE

Customer Premises Equipment. It refers to any terminal or equipment located at the customer premises.

CPsec

Control Plane Security. CPsec is a secure form of communication between a controller and APs to protect the control plane communications. This is performed by means of using public-key self-signed certificates created by each master controller.

CPU

Central Processing Unit. A CPU is an electronic circuitry in a computer for processing instructions.

CRC

Cyclic Redundancy Check. CRC is a data verification method for detecting errors in digital data during transmission, storage, or retrieval.

CRL

Certificate Revocation List. CRL is a list of revoked certificates maintained by a certification authority.

cryptobinding

Short for cryptographic binding. A procedure in a tunneled EAP method that binds together the tunnel protocol and the tunneled authentication methods, ensuring the relationship between a collection of data assets. Cryptographic binding focuses on protecting the server; mutual cryptographic binding protects both peer and server.

CSA

Channel Switch Announcement. The CSA element enables an AP to advertise that it is switching to a new channel before it begins transmitting on that channel. This allows the clients, which support CSA, to transition to the new channel with minimal downtime.

CSMA/CA

Carrier Sense Multiple Access / Collision Avoidance. CSMA/CA is a protocol for carrier transmission in networks using the 802.11 standard. CSMA/CA aims to prevent collisions by listening to the broadcasting nodes, and informing devices not to transmit any data until the broadcasting channel is free.

CSR

Certificate Signing Request. In PKI systems, a CSR is a message sent from an applicant to a CA to apply for a digital identity certificate.

CSV

Comma-Separated Values. A file format that stores tabular data in the plain text format separated by commas.

CTS

Clear to Send. The CTS refers to the data transmission and protection mechanism used by the 802.11 wireless networking protocol to prevent frame collision occurrences. See RTS.

CW

Contention Window. In QoS, CW refers to a window set for access categories based on the type of traffic. Based on the type and volume of the traffic, the minimum and maximum values can be calculated to provide a wider window when necessary.

DAI

Dynamic ARP inspection. A security feature that validates ARP packets in a network.

DAS

Distributed Antenna System. DAS is a network of antenna nodes strategically placed around a geographical area or structure for additional cellular coverage.

dB

Decibel. Unit of measure for sound or noise and is the difference or ratio between two signal levels.

dBm

Decibel-Milliwatts. dBm is a logarithmic measurement (integer) that is typically used in place of mW to represent receive-power level. AMP normalizes all signals to dBm, so that it is easy to evaluate performance between various vendors.

DCB

Data Center Bridging. DCB is a collection of standards developed by IEEE for creating a converged data center network using Ethernet.

DCE

Data Communication Equipment. DCE refers to the devices that establish, maintain, and terminate communication network sessions between a data source and its destination.

DCF

Distributed Coordination Function. DCF is a protocol that uses carrier sensing along with a four-way handshake to maximize the throughput while preventing packet collisions.

DDMO

Distributed Dynamic Multicast Optimization. DDMO is similar to Dynamic Multicast Optimization (DMO) where the multicast streams are converted into unicast streams on the AP instead of the controller, to

enhance the quality and reliability of streaming videos, while preserving the bandwidth available to non-video clients.

DES

Data Encryption Standard. DES is a common standard for data encryption and a form of secret key cryptography, which uses only one key for encryption and decryption.

designated router

Designated router refers to a router interface that is elected to originate network link advertisements for networks using the OSPF protocol.

destination NAT

Destination Network Address Translation. Destination NAT is a process of translating the destination IP address of an end route packet in a network. Destination NAT is used for redirecting the traffic destined to a virtual host to the real host, where the virtual host is identified by the destination IP address and the real host is identified by the translated IP address.

DFS

Dynamic Frequency Selection. DFS is a mandate for radio systems operating in the 5 GHz band to be equipped with means to identify and avoid interference with Radar systems.

DFT

Discrete Fourier Transform. DFT converts discrete-time data sets into a discrete-frequency representation. See FFT.

DHCP

Dynamic Host Configuration Protocol. A network protocol that enables a server to automatically assign an IP address to an IP-enabled device from a defined range of numbers configured for a given network.

DHCP snooping

DHCP snooping enables the switch to monitor and control DHCP messages received from untrusted devices that are connected to the switch.

digital certificate

A digital certificate is an electronic document that uses a digital signature to bind a public key with an identity—information such as the name of a person or an organization, address, and so forth.

Digital wireless pulse

A wireless technology for transmitting large amounts of digital data over a wide spectrum of frequency bands with very low power for a short distance. Ultra Wideband radio can carry a huge amount of data over a distance up to 230 ft at very low power (less than 0.5 mW), and has the ability to carry signals through doors and other obstacles that tend to reflect signals at more limited bandwidths and a higher power.

Disconnect-Ack

Disconnect-Ack is a NAS response packet to a Disconnect-Request, which indicates that the session was disconnected.

Disconnect-Nak

Disconnect-Nak is NAS response packet to a Disconnect-Request, which indicates that the session was not disconnected.

Disconnect-Request

Disconnect-Request is a RADIUS packet type sent to a NAS requesting that a user or session be disconnected.

distribution certificate

Distribution certificate is used for digitally signing iOS mobile apps to enable enterprise app distribution. It verifies the identity of the app publisher.

DLNA

Digital Living Network Alliance. DLNA is a set of interoperability guidelines for sharing digital media among multimedia devices.

DMO

Dynamic Multicast Optimization. DMO is a process of converting multicast streams into unicast streams over a wireless link to enhance the quality and reliability of streaming videos, while preserving the bandwidth available to non-video clients.

DN

Distinguished Name. A series of fields in a digital certificate that, taken together, constitute the unique identity of the person or device that owns the digital certificate. Common fields in a DN include country, state, locality, organization, organizational unit, and the "common name", which is the primary name used to identify the certificate.

DNS

Domain Name System. A DNS server functions as a phone book for the intranet and Internet users. It converts human-readable computer host names into IP addresses and IP addresses into host names. It stores several records for a domain name such as an address 'A' record, name server (NS), and mail exchanger (MX) records. The Address 'A' record is the most important record that is stored in a DNS server, because it provides the required IP address for a network peripheral or element.

DOCSIS

Data over Cable Service Interface Specification. A telecommunication standard for Internet access through cable modem.

DoS

Denial of Service. DoS is any type of attack where the attackers send excessive messages to flood traffic and thereby preventing the legitimate users from accessing the service.

DPD

Dead Peer Detection. A method used by the network devices to detect the availability of the peer devices.

DPI

Deep Packet Inspection. DPI is an advanced method of network packet filtering that is used for inspecting data packets exchanged between the devices and systems over a network. DPI functions at the Application layer of the Open Systems Interconnection (OSI) reference model and enables users to identify, categorize, track, reroute, or stop packets passing through a network.

DRT

Downloadable Regulatory Table. The DRT feature allows new regulatory approvals to be distributed for APs without a software upgrade or patch.

DS

Differentiated Services. The DS specification aims to provide uninterrupted quality of service by managing and controlling the network traffic, so that certain types of traffic get precedence.

DSCP

Differentiated Services Code Point. DSCP is a 6-bit packet header value used for traffic classification and priority assignment.

DSL

Digital Subscriber Line. The DSL technology allows the transmission of digital data over telephone lines. A DSL modem is a device used for connecting a computer or router to a telephone line that offers connectivity to the Internet.

DSSS

Direct-Sequence Spread Spectrum. DSSS is a modulation technique used for reducing overall signal interference. This technique multiplies the original data signal with a pseudo random noise spreading code. Spreading of this signal makes the resulting wideband channel more noisy, thereby increasing the resistance to interference. See FHSS.

DST

Daylight Saving Time. DST is also known as summer time that refers to the practice of advancing clocks, so that evenings have more daylight and mornings have less. Typically clocks are adjusted forward one hour near the start of spring and are adjusted backward in autumn.

DTE

Data Terminal Equipment. DTE refers to a device that converts user information into signals or re-converts the received signals.

DTIM

Delivery Traffic Indication Message. DTIM is a kind of traffic indication map. A DTIM interval determines when the APs must deliver broadcast and multicast frames to their associated clients in power save mode.

DTLS

Datagram Transport Layer Security. DTLS communications protocol provides communications security for datagram protocols.

dynamic authorization

Dynamic authorization refers to the ability to make changes to a visitor account's session while it is in progress. This might include disconnecting a session or updating some aspect of the authorization for the session.

dynamic NAT

Dynamic Network Address Translation. Dynamic NAT maps multiple public IP addresses and uses these addresses with an internal or private IP address. Dynamic NAT helps to secure a network by masking the internal configuration of a private network.

EAP

Extensible Authentication Protocol. An authentication protocol for wireless networks that extends the methods used by the PPP, a protocol often used when connecting a computer to the Internet. EAP can support multiple authentication mechanisms, such as token cards, smart cards, certificates, one-time passwords, and public key encryption authentication.

EAP-FAST

EAP – Flexible Authentication Secure Tunnel (tunneled).

EAP-GTC

EAP – Generic Token Card. (non-tunneled).

EAP-MD5

EAP – Method Digest 5. (non-tunneled).

EAP-MSCHAP

EAP Microsoft Challenge Handshake Authentication Protocol.

EAP-MSCHAPv2

EAP Microsoft Challenge Handshake Authentication Protocol Version 2.

EAP-PEAP

EAP–Protected EAP. A widely used protocol for securely transporting authentication data across a network (tunneled).

EAP-PWD

EAP-Password. EAP-PWD is an EAP method that uses a shared password for authentication.

EAP-TLS

EAP–Transport Layer Security. EAP-TLS is a certificate-based authentication method supporting mutual authentication, integrity-protected ciphersuite negotiation and key exchange between two endpoints. See RFC 5216.

EAP-TTLS

EAP–Tunneled Transport Layer Security. EAP-TTLS is an EAP method that encapsulates a TLS session, consisting of a handshake phase and a data phase. See RFC 5281.

EAPoL

Extensible Authentication Protocol over LAN. A network port authentication protocol used in IEEE 802.1X standards to provide a generic network sign-on to access network resources.

ECC

Elliptical Curve Cryptography or Error correcting Code memory. Elliptical Curve Cryptography is a public-key encryption technique that is based on elliptic curve theory used for creating faster, smaller, and more efficient cryptographic keys. Error Correcting Code memory is a type of computer data storage that can detect and correct the most common kinds of internal data corruption. ECC memory is used in most computers where data corruption cannot be tolerated under any circumstances, such as for scientific or financial computing.

ECDSA

Elliptic Curve Digital Signature Algorithm. ECDSA is a cryptographic algorithm that supports the use of public or private key pairs for encrypting and decrypting information.

EDCA

Enhanced Distributed Channel Access. The EDCA function in the IEEE 802.11e Quality of Service standard supports differentiated and distributed access to wireless medium based on traffic priority and Access Category types. See WMM and WME.

EIGRP

Enhanced Interior Gateway Routing Protocol. EIGRP is a routing protocol used for automating routing decisions and configuration in a network.

EIRP

Effective Isotropic Radiated Power or Equivalent Isotropic Radiated Power. EIRP refers to the output power generated when a signal is concentrated into a smaller area by the Antenna.

ESI

External Services Interface. ESI provides an open interface for integrating security solutions that solve interior network problems such as viruses, worms, spyware, and corporate compliance.

ESS

Extended Service Set. An ESS is a set of one or more interconnected BSSs that form a single sub network.

ESSID

Extended Service Set Identifier. ESSID refers to the ID used for identifying an extended service set.

Ethernet

Ethernet is a network protocol for data transmission over LAN.

EULA

End User License Agreement. EULA is a legal contract between a software application publisher or author and the users of the application.

FCC

Federal Communications Commission. FCC is a regulatory body that defines standards for the interstate and international communications by radio, television, wire, satellite, and cable.

FFT

Fast Fourier Transform. FFT is a frequency analysis mechanism that aims at faster conversion of a discrete signal in time domain into a discrete frequency domain representation. See also DFT.

FHSS

Frequency Hopping Spread Spectrum. FHSS is transmission technique that allows modulation and transmission of a data signal by rapidly switching a carrier among many frequency channels in a random but predictable sequence. See also DSSS.

FIB

Forwarding Information Base. FIB is a forwarding table that maps MAC addresses to ports. FIB is used in network bridging, routing, and similar functions to identify the appropriate interface for forwarding packets.

FIPS

Federal Information Processing Standards. FIPS refers to a set of standards that describe document processing, encryption algorithms, and other information technology standards for use within non-military government agencies, and by government contractors and vendors who work with these agencies.

firewall

Firewall is a network security system used for preventing unauthorized access to or from a private network.

FQDN

Fully Qualified Domain Name. FQDN is a complete domain name that identifies a computer or host on the Internet.

FQLN

Fully Qualified Location Name. FQLN is a device location identifier in the format: APname.Floor.Building.Campus.

frequency allocation

Use of radio frequency spectrum as regulated by governments.

FSPL

Free Space Path Loss. FSPL refers to the loss in signal strength of an electromagnetic wave that would result from a line-of-sight path through free space (usually air), with no obstacles nearby to cause reflection or diffraction.

FTP

File Transfer Protocol. A standard network protocol used for transferring files between a client and server on a computer network.

GARP

Generic Attribute Registration Protocol. GARP is a LAN protocol that allows the network nodes to register and de-register attributes, such as network addresses, with each other.

GAS

Generic Advertisement Service. GAS is a request-response protocol, which provides Layer 2 transport mechanism between a wireless client and a server in the network prior to authentication. It helps in determining a wireless network infrastructure before associating clients, and allows clients to send queries to multiple 802.11 networks in parallel.

gateway

Gateway is a network node that allows traffic to flow in and out of the network.

Gbps

Gigabits per second.

GBps

Gigabytes per second.

GET

GET refers HTTP request method or an SNMP operation method. The GET HTTP request method submits data to be processed to a specified resource. The GET SNMP operation method obtains information from the Management Information Base (MIB).

GHz

Gigahertz.

GMT

Greenwich Mean Time. GMT refers to the mean solar time at the Royal Observatory in Greenwich, London. GMT is the same as Coordinated Universal Time (UTC) standard, written as an offset of UTC +/- 00:00.

goodput

Goodput is the application level throughput that refers to the ratio of the total bytes transmitted or received in the network to the total air time required for transmitting or receiving the bytes.

GPS

Global Positioning System. A satellite-based global navigation system.

GRE

Generic Routing Encapsulation. GRE is an IP encapsulation protocol that is used to transport packets over a network.

GTC

Generic Token Card. GTC is a protocol that can be used as an alternative to MSCHAPv2 protocol. GTC allows authentication to various authentication databases even in cases where MSCHAPv2 is not supported by the database.

GVRP

GARP VLAN Registration Protocol or Generic VLAN Registration Protocol. GARP is an IEEE 802.1Q-compliant protocol that facilitates VLAN registration and controls VLANs within a larger network.

H2QP

Hotspot 2.0 Query Protocol.

hot zone

Wireless access area created by multiple hotspots that are located in close proximity to one another. Hot zones usually combine public safety APs with public hotspots.

hotspot

Hotspot refers to a WLAN node that provides Internet connection and virtual private network (VPN) access from a given location. A business traveler, for example, with a laptop equipped for Wi-Fi can look up a local hotspot, contact it, and get connected through its network to reach the Internet.

HSPA

High-Speed Packet Access.

HT

High Throughput. IEEE 802.11n is an HT WLAN standard that aims to achieve physical data rates of close to 600 Mbps on the 2.4 GHz and 5 GHz bands.

HTTP

Hypertext Transfer Protocol. The HTTP is an application protocol to transfer data over the web. The HTTP protocol defines how messages are formatted and transmitted, and the actions that the w servers and browsers should take in response to various commands.

HTTPS

Hypertext Transfer Protocol Secure. HTTPS is a variant of the HTTP that adds a layer of security on the data in transit through a secure socket layer or transport layer security protocol connection.

IAS

Internet Authentication Service. IAS is a component of Windows Server operating systems that provides centralized user authentication, authorization, and accounting.

ICMP

Internet Control Message Protocol. ICMP is an error reporting protocol. It is used by network devices such as routers, to send error messages and operational information to the source IP address when network problems prevent delivery of IP packets.

IDS

Intrusion Detection System. IDS monitors a network or systems for malicious activity or policy violations and reports its findings to the management system deployed in the network.

IEEE

Institute of Electrical and Electronics Engineers.

IGMP

Internet Group Management Protocol. Communications protocol used by hosts and adjacent routers on IP networks to establish multicast group memberships.

IGMP snooping

IGMP snooping prevents multicast flooding on Layer 2 network by treating multicast traffic as broadcast traffic. Without IGMP snooping, all streams could be flooded to all ports on that VLAN. When multicast flooding occurs, end-hosts that happen to be in the same VLAN would receive all the streams only to be discarded without snooping.

IGP

Interior Gateway Protocol. IGP is used for exchanging routing information between gateways within an autonomous system (for example, a system of corporate local area networks).

IGRP

Interior Gateway Routing Protocol. IGRP is a distance vector interior routing protocol used by routers to exchange routing data within an autonomous system.

IKE

Internet Key Exchange. IKE is a key management protocol used with IPsec protocol to establish a secure communication channel. IKE provides additional feature, flexibility, and ease of configuration for IPsec standard.

IKEv1

Internet Key Exchange version 1. IKEv1 establishes a secure authenticated communication channel by using either the pre-shared key (shared secret), digital signatures, or public key encryption. IKEv1 operates in Main and Aggressive modes. See RFC 2409.

IKEv2

Internet Key Exchange version 2. IKEv2 uses the secure channel established in Phase 1 to negotiate Security Associations on behalf of services such as IPsec. IKEv2 uses pre-shared key and Digital Signature for authentication. See RFC 4306.

IoT

Internet of Things. IoT refers to the internetworking of devices that are embedded with electronics, software, sensors, and network connectivity features allowing data exchange over the Internet.

IPM

Intelligent Power Monitoring. IPM is a feature supported on certain APs that actively measures the power utilization of an AP and dynamically adapts to the power resources.

IPS

Intrusion Prevention System. The IPS monitors a network for malicious activities such as security threats or policy violations. The main function of an IPS is to identify suspicious activity, log the information, attempt to block the activity, and report it.

IPsec

Internet Protocol security. IPsec is a protocol suite for secure IP communications that authenticates and encrypts each IP packet in a communication session.

IPSG

Internet Protocol Source Guard. IPSG restricts IP address from untrusted interface by filtering traffic based on list of addresses in the DHCP binding database or manually configured IP source bindings. It prevents IP spoofing attacks.

IrDA

An industry-sponsored organization set up in 1993 to create international standards for the hardware and software used in infrared communication links. In this special form of radio transmission, a focused ray of light in the infrared frequency spectrum, measured in terahertz (THz), or trillions of hertz (cycles per second), is modulated with information and sent from a transmitter to a receiver over a relatively short distance.

ISAKMP

Internet Security Association and Key Management Protocol. ISAKMP is used for establishing Security Associations and cryptographic keys in an Internet environment.

ISP

Internet Service Provider. An ISP is an organization that provides services for accessing and using the Internet.

JSON

JavaScript Object Notation. JSON is an open-standard, language-independent, lightweight data-interchange format used to transmit data objects consisting of attribute–value pairs. JSON uses a "self-describing" text format that is easy for humans to read and write, and that can be used as a data format by any programming language.

Kbps

Kilobits per second.

KBps

Kilobytes per second.

keepalive

Signal sent at periodic intervals from one device to another to verify that the link between the two devices is working. If no reply is received, data will be sent by a different path until the link is restored. A keepalive can also be used to indicate that the connection should be preserved so that the receiving device does not consider it timed out and drop it.

L2TP

Layer-2 Tunneling Protocol. L2TP is a networking protocol used by the ISPs to enable VPN operations.

LACP

Link Aggregation Control Protocol. LACP is used for the collective handling of multiple physical ports that can be seen as a single channel for network traffic purposes.

LAG

Link Aggregation Group . A LAG combines a number of physical ports together to make a single high-bandwidth data path. LAGs can connect two switches to provide a higher-bandwidth connection to a public network.

LAN

Local Area Network. A LAN is a network of connected devices within a distinct geographic area such as an office or a commercial establishment and share a common communications line or wireless link to a server.

LCD

Liquid Crystal Display. LCD is the technology used for displays in notebook and other smaller computers. Like LED and gas-plasma technologies, LCDs allow displays to be much thinner than the cathode ray tube technology.

LDAP

Lightweight Directory Access Protocol. LDAP is a communication protocol that provides the ability to access and maintain distributed directory information services over a network.

LDPC

Low-Density Parity-Check. LDPC is a method of transmitting a message over a noisy transmission channel using a linear error correcting code. An LDPC is constructed using a sparse bipartite graph.

LEAP

Lightweight Extensible Authentication Protocol. LEAP is a Cisco proprietary version of EAP used in wireless networks and Point-to-Point connections.

LED

Light Emitting Diode. LED is a semiconductor light source that emits light when an electric current passes through it.

LEEF

Log Event Extended Format. LEEF is a type of customizable syslog event format. An extended log file contains a sequence of lines containing ASCII characters terminated by either the sequence LF or CRLF.

LI

Lawful Interception. LI refers to the procedure of obtaining communications network data by the Law Enforcement Agencies for the purpose of analysis or evidence.

LLDP

Link Layer Discovery Protocol. LLDP is a vendor-neutral link layer protocol in the Internet Protocol suite used by network devices for advertising their identity, capabilities, and neighbors on an IEEE 802 local area network, which is principally a wired Ethernet.

LLDP-MED

LLDP–Media Endpoint Discovery. LLDP-MED facilitates information sharing between endpoints and network infrastructure devices.

LMS

Local Management Switch. In multi-controller networks, each controller acts as an LMS and terminates user traffic from the APs, processes, and forwards the traffic to the wired network.

LNS

L2TP Network Server. LNS is an equipment that connects to a carrier and handles the sessions from broadband lines. It is also used for dial-up and mobile links. LNS handles authentication and routing of the IP addresses. It also handles the negotiation of the link with the equipment and establishes a session.

LTE

Long Term Evolution. LTE is a 4G wireless communication standard that provides high-speed wireless communication for mobile phones and data terminals. See 4G.

MAB

MAC Authentication Bypass. Endpoints such as network printers, Ethernet-based sensors, cameras, and wireless phones do not support 802.1X authentication. For such endpoints, MAC Authentication Bypass mechanism is used. In this method, the MAC address of the endpoint is used to authenticate the endpoint.

MAC

Media Access Control. A MAC address is a unique identifier assigned to network interfaces for communications on a network.

MAM

Mobile Application Management. MAM refers to software and services used to secure, manage, and distribute mobile applications used in enterprise settings on mobile devices like smartphones and tablet computers. Mobile Application Management can apply to company-owned mobile devices as well as BYOD.

Mbps

Megabits per second

MBps

Megabytes per second

MCS

Modulation and Coding Scheme. MCS is used as a parameter to determine the data rate of a wireless connection for high throughput.

MD4

Message Digest 4. MD4 is an earlier version of MD5 and is an algorithm used to verify data integrity through the creation of a 128-bit message digest from data input.

MD5

Message Digest 5. The MD5 algorithm is a widely used hash function producing a 128-bit hash value from the data input.

MDAC

Microsoft Data Access Components. MDAC is a framework of interrelated Microsoft technologies that provides a standard database for Windows OS.

MDM

Mobile Device Management. MDM is an administrative software to manage, monitor, and secure mobile devices of the employees in a network.

mDNS

Multicast Domain Name System. mDNS provides the ability to perform DNS-like operations on the local link in the absence of any conventional unicast DNS server. The mDNS protocol uses IP multicast User Datagram Protocol (UDP) packets, and is implemented by the Apple Bonjour and Linux NSS-mDNS services. mDNS works in conjunction with DNS Service Discovery (DNS-SD), a companion zero-configuration technique specified. See RFC 6763.

MFA

Multi-factor Authentication. MFA lets you require multiple factors, or proofs of identity, when authenticating a user. Policy configurations define how often multi-factor authentication will be required, or conditions that will trigger it.

MHz

Megahertz

MIB

Management Information Base. A hierarchical database used by SNMP to manage the devices being monitored.

microwave

Electromagnetic energy with a frequency higher than 1 GHz, corresponding to wavelength shorter than 30 centimeters.

MIMO

Multiple Input Multiple Output. An antenna technology for wireless communications in which multiple antennas are used at both source (transmitter) and destination (receiver). The antennas at each end of the communications circuit are combined to minimize errors and optimize data speed.

MISO

Multiple Input Single Output. An antenna technology for wireless communications in which multiple antennas are used at the source (transmitter). The antennas are combined to minimize errors and optimize data speed. The destination (receiver) has only one antenna.

MLD

Multicast Listener Discovery. A component of the IPv6 suite. It is used by IPv6 routers for discovering multicast listeners on a directly attached link.

MPDU

MAC Protocol Data Unit. MPDU is a message exchanged between MAC entities in a communication system based on the layered OSI model.

MPLS

Multiprotocol Label Switching. The MPLS protocol speeds up and shapes network traffic flows.

MPPE

Microsoft Point-to-Point Encryption. A method of encrypting data transferred across PPP-based dial-up connections or PPTP-based VPN connections.

MS-CHAP

Microsoft Challenge Handshake Authentication Protocol. MS-CHAP is Password-based, challenge-response, mutual authentication protocol that uses MD4 and DES encryption.

MS-CHAPv1

Microsoft Challenge Handshake Authentication Protocol version 1. MS-CHAPv1 extends the user authentication functionality provided on Windows networks to remote workstations. MS-CHAPv1 supports only one-way authentication.

MS-CHAPv2

Microsoft Challenge Handshake Authentication Protocol version 2. MS-CHAPv2 is an enhanced version of the MS-CHAP protocol that supports mutual authentication.

MSS

Maximum Segment Size. MSS is a parameter of the options field in the TCP header that specifies the largest amount of data, specified in bytes, that a computer or communications device can receive in a single TCP segment.

MSSID

Mesh Service Set Identifier. MSSID is the SSID used by the client to access a wireless mesh network.

MSTP

Multiple Spanning Tree Protocol. MSTP configures a separate Spanning Tree for each VLAN group and blocks all but one of the possible alternate paths within each spanning tree.

MTU

Maximum Transmission Unit. MTU is the largest size packet or frame specified in octets (eight-bit bytes) that can be sent in networks such as the Internet.

MU-MIMO

Multi-User Multiple-Input Multiple-Output. MU-MIMO is a set of multiple-input and multiple-output technologies for wireless communication, in which users or wireless terminals with one or more antennas

communicate with each other.

MVRP

Multiple VLAN Registration Protocol. MVRP is a Layer 2 network protocol used for automatic configuration of VLAN information on switches.

mW

milliWatts. mW is 1/1000 of a Watt. It is a linear measurement (always positive) that is generally used to represent transmission.

NAC

Network Access Control. NAC is a computer networking solution that uses a set of protocols to define and implement a policy that describes how devices can secure access to network nodes when they initially attempt to connect to a network.

NAD

Network Access Device. NAD is a device that automatically connects the user to the preferred network, for example, an AP or an Ethernet switch.

NAK

Negative Acknowledgement. NAK is a response indicating that a transmitted message was received with errors or it was corrupted, or that the receiving end is not ready to accept transmissions.

NAP

Network Access Protection. The NAP feature in the Windows Server allows network administrators to define specific levels of network access based on identity, groups, and policy compliance. The NAP Agent is a service that collects and manages health information for NAP client computers. If a client is not compliant, NAP provides a mechanism to automatically bring the client back into compliance and then dynamically increase its level of network access.

NAS

Network Access Server. NAS provides network access to users, such as a wireless AP, network switch, or dial-in terminal server.

NAT

Network Address Translation. NAT is a method of remapping one IP address space into another by modifying network address information in Internet Protocol (IP) datagram packet headers while they are in transit across a traffic routing device.

NetBIOS

Network Basic Input/Output System. A program that lets applications on different computers communicate within a LAN.

netmask

Netmask is a 32-bit mask used for segregating IP address into subnets. Netmask defines the class and range of IP addresses.

NFC

Near-Field Communication. NFC is a short-range wireless connectivity standard (ECMA-340, ISO/IEC 18092) that uses magnetic field induction to enable communication between devices when they touch or are brought closer (within a few centimeters of distance). The standard specifies a way for the devices to establish a peer-to-peer (P2P) network to exchange data.

NIC

Network Interface Card. NIC is a hardware component that allows a device to connect to the network.

Nmap

Network Mapper. Nmap is an open-source utility for network discovery and security auditing. Nmap uses IP packets to determine such things as the hosts available on a network and their services, operating systems and versions, types of packet filters/firewalls, and so on.

NMI

Non-Maskable Interrupt. NMI is a hardware interrupt that standard interrupt-masking techniques in the system cannot ignore. It typically occurs to signal attention for non-recoverable hardware errors.

NMS

Network Management System. NMS is a set of hardware and/or software tools that allow an IT professional to supervise the individual components of a network within a larger network management framework.

NOE

New Office Environment. NOE is a proprietary VoIP protocol designed by Alcatel-Lucent Enterprise.

NTP

Network Time Protocol. NTP is a protocol for synchronizing the clocks of computers over a network.

OAuth

Open Standard for Authorization. OAuth is a token-based authorization standard that allows websites or third-party applications to access user information, without exposing the user credentials.

OCSP

Online Certificate Status Protocol. OCSP is used for determining the current status of a digital certificate without requiring a CRL.

OFDM

Orthogonal Frequency Division Multiplexing. OFDM is a scheme for encoding digital data on multiple carrier frequencies.

OID

Object Identifier. An OID is an identifier used to name an object. The OIDs represent nodes or managed objects in a MIB hierarchy. The OIDs are designated by text strings and integer sequences and are formally defined as per the ASN.1 standard.

OKC

Opportunistic Key Caching. OKC is a technique available for authentication between multiple APs in a network where those APs are under common administrative control. Using OKC, a station roaming to any AP in the network will not have to complete a full authentication exchange, but will instead just perform the 4-way handshake to establish transient encryption keys.

onboarding

The process of preparing a device for use on an enterprise network, by creating the appropriate access credentials and setting up the network connection parameters.

OpenFlow

OpenFlow is an open communications interface between control plane and the forwarding layers of a network.

OpenFlow agent

OpenFlow agent. OpenFlow is a software module in Software-Defined Networking (SDN) that allows the abstraction of any legacy network element, so that it can be integrated and managed by the SDN controller. OpenFlow runs on network devices such as switches, routers, wireless controllers, and APs.

Optical wireless

Optical wireless is combined use of conventional radio frequency wireless and optical fiber for telecommunication. Long-range links are provided by using optical fibers; the links from the long-range endpoints to end users are accomplished by RF wireless or laser systems. RF wireless at Ultra High Frequencies and microwave frequencies can carry broadband signals to individual computers at substantial data speeds.

OSI

Open Systems Interconnection. OSI is a reference model that defines a framework for communication between the applications in a network.

OSPF

Open Shortest Path First. OSPF is a link-state routing protocol for IP networks. It uses a link-state routing algorithm and falls into the group of interior routing protocols that operates within a single Autonomous System (AS).

OSPFv2

Open Shortest Path First version 2. OSPFv2 is the version 2 of the link-state routing protocol, OSPF. See RFC 2328.

OUI

Organizationally Unique Identifier. Synonymous with company ID or vendor ID, an OUI is a 24-bit, globally unique assigned number, referenced by various standards. The first half of a MAC address is OUI.

OVA

Open Virtualization Archive. OVA contains a compressed installable version of a virtual machine.

OVF

Open Virtualization Format. OVF is a specification that describes an open-standard, secure, efficient, portable and extensible format for packaging and distributing software for virtual machines.

PAC

Protected Access Credential. PAC is distributed to clients for optimized network authentication. These credentials are used for establishing an authentication tunnel between the client and the authentication server.

PAP

Password Authentication Protocol. PAP validates users by password. PAP does not encrypt passwords for transmission and is thus considered insecure.

PAPI

Process Application Programming Interface. PAPI controls channels for ARM and Wireless Intrusion Detection System (WIDS) communication to the master controller. A separate PAPI control channel connects to the local controller where the SSID tunnels terminate.

PBR

Policy-based Routing. PBR provides a flexible mechanism for forwarding data packets based on policies configured by a network administrator.

PDU

Power Distribution Unit or Protocol Data Unit. Power Distribution Unit is a device that distributes electric power to the networking equipment located within a data center. Protocol Data Unit contains protocol control information that is delivered as a unit among peer entities of a network.

PEAP

Protected Extensible Authentication Protocol. PEAP is a type of EAP communication that addresses security issues associated with clear text EAP transmissions by creating a secure channel encrypted and protected by TLS.

PEF

Policy Enforcement Firewall. PEF also known as PEFNG provides context-based controls to enforce application-layer security and prioritization. The customers using Aruba mobility controllers can avail PEF features and services by obtaining a PEF license. PEF for VPN users—Customers with PEF for VPN license can apply firewall policies to the user traffic routed to a controller through a VPN tunnel.

PEFNG

Policy Enforcement Firewall. PEF also known as PEFNG provides context-based controls to enforce application-layer security and prioritization. The customers using Aruba mobility controllers can avail PEF features and services by obtaining a PEF license. PEF for VPN users—Customers with PEF for VPN license can apply firewall policies to the user traffic routed to a controller through a VPN tunnel.

PEFV

Policy Enforcement Firewall. PEF also known as PEFNG provides context-based controls to enforce application-layer security and prioritization. The customers using Aruba mobility controllers can avail PEF

features and services by obtaining a PEF license. PEF for VPN users—Customers with PEF for VPN license can apply firewall policies to the user traffic routed to a controller through a VPN tunnel.

PFS

Perfect Forward Secrecy. PFS refers to the condition in which a current session key or long-term private key does not compromise the past or subsequent keys.

PHB

Per-hop behavior. PHB is a term used in DS or MPLS. It defines the policy and priority applied to a packet when traversing a hop (such as a router) in a DiffServ network.

PIM

Protocol-Independent Multicast. PIM refers to a family of multicast routing protocols for IP networks that provide one-to-many and many-to-many distribution of data over a LAN, WAN, or the Internet.

PIN

Personal Identification Number. PIN is a numeric password used to authenticate a user to a system.

PKCS#n

Public-key cryptography standard n. PKCS#n refers to a numbered standard related to topics in cryptography, including private keys (PKCS#1), digital certificates (PKCS#7), certificate signing requests (PKCS#10), and secure storage of keys and certificates (PKCS#12).

PKI

Public Key Infrastructure. PKI is a security technology based on digital certificates and the assurances provided by strong cryptography. See also certificate authority, digital certificate, public key, private key.

PLMN

Public Land Mobile Network. PLMS is a network established and operated by an administration or by a Recognized Operating Agency for the specific purpose of providing land mobile telecommunications services to the public.

PMK

Pairwise Master Key. PMK is a shared secret key that is generated after PSK or 802.1X authentication.

PoE

Power over Ethernet. PoE is a technology for wired Ethernet LANs to carry electric power required for the device in the data cables. The IEEE 802.3af PoE standard provides up to 15.4 W of power on each port.

PoE+

Power over Ethernet+. PoE+ is an IEEE 802.3at standard that provides 25.5W power on each port.

POST

Power On Self Test. An HTTP request method that requests data from a specified resource.

PPP

Point-to-Point Protocol. PPP is a data link (layer 2) protocol used to establish a direct connection between two nodes. It can provide connection authentication, transmission encryption, and compression.

PPPoE

Point-to-Point Protocol over Ethernet. PPPoE is a method of connecting to the Internet, typically used with DSL services, where the client connects to the DSL modem.

PPTP

Point-to-Point Tunneling Protocol. PPTP is a method for implementing virtual private networks. It uses a control channel over TCP and a GRE tunnel operating to encapsulate PPP packets.

private key

The part of a public-private key pair that is always kept private. The private key encrypts the signature of a message to authenticate the sender. The private key also decrypts a message that was encrypted with the public key of the sender.

PRNG

Pseudo-Random Number Generator. PRNG is an algorithm for generating a sequence of numbers whose properties approximate the properties of sequences of random numbers.

PSK

Pre-shared key. A unique shared secret that was previously shared between two parties by using a secure channel. This is used with WPA security, which requires the owner of a network to provide a passphrase to users for network access.

PSU

Power Supply Unit. PSU is a unit that supplies power to an equipment by converting mains AC to low-voltage regulated DC power.

public key

The part of a public-private key pair that is made public. The public key encrypts a message and the message is decrypted with the private key of the recipient.

PVST

Per-VLAN Spanning Tree. PVST provides load balancing of VLANs across multiple ports resulting in optimal usage of network resources.

PVST+

Per-VLAN Spanning Tree+. PVST+ is an extension of the PVST standard that uses the 802.1Q trunking technology.

QoS

Quality of Service. It refers to the capability of a network to provide better service and performance to a specific network traffic over various technologies.

RA

Router Advertisement. The RA messages are sent by the routers in the network when the hosts send multicast router solicitation to the multicast address of all routers.

Radar

Radio Detection and Ranging. Radar is an object-detection system that uses radio waves to determine the range, angle, or velocity of objects.

RADIUS

Remote Authentication Dial-In User Service. An Industry-standard network access protocol for remote authentication. It allows authentication, authorization, and accounting of remote users who want to access network resources.

RAM

Random Access Memory.

RAPIDS

Rogue Access Point identification and Detection System. An AMP module that is designed to identify and locate wireless threats by making use of all of the information available from your existing infrastructure.

RARP

Reverse Address Resolution Protocol. RARP is a protocol used by a physical machine in a local area network for determining the IP address from the ARP table or cache of the gateway server.

Regex

Regular Expression. Regex refers to a sequence of symbols and characters defining a search pattern.

Registration Authority

Type of Certificate Authority that processes certificate requests. The Registration Authority verifies that requests are valid and comply with certificate policy, and authenticates the user's identity. The Registration Authority then forwards the request to the Certificate Authority to sign and issue the certificate.

Remote AP

Remote APs extend corporate network to the users working from home or at temporary work sites. Remote APs are deployed at branch office sites and are connected to the central network on a WAN link.

REST

Representational State Transfer. REST is a simple and stateless architecture that the web services use for providing interoperability between computer systems on the Internet. In a RESTful web service, requests made to the URI of a resource will elicit a response that may be in XML, HTML, JSON or some other defined format.

RF

Radio Frequency. RF refers to the electromagnetic wave frequencies within a range of 3 kHz to 300 GHz, including the frequencies used for communications or Radar signals.

RFC

Request For Comments. RFC is a commonly used format for the Internet standards documents.

RFID

Radio Frequency Identification. RFID uses radio waves to automatically identify and track the information stored on a tag attached to an object.

RIP

Routing Information Protocol. RIP prevents the routing loops by limiting the number of hops allowed in a path from source to destination.

RJ45

Registered Jack 45. RJ45 is a physical connector for network cables.

RMA

Return Merchandise Authorization. RMA is a part of the product returning process that authorizes users to return a product to the manufacturer or distributor for a refund, replacement, or repair. The customers who want to return a product within its Warranty period contact the manufacturer to initiate the product returning process. The manufacturer or the seller generates an authorization number for the RMA, which is used by the customers, when returning a product to the warehouse.

RMON

Remote Monitoring. RMON provides standard information that a network administrator can use to monitor, analyze, and troubleshoot a group of distributed LANs.

RoW

Rest of World. RoW or RW is an operating country code of a device.

RSA

Rivest, Shamir, Adleman. RSA is a cryptosystem for public-key encryption, and is widely used for securing sensitive data, particularly when being sent over an insecure network such as the Internet.

RSSI

Received Signal Strength Indicator. RSSI is a mechanism by which RF energy is measured by the circuitry on a wireless NIC (0-255). The RSSI is not standard across vendors. Each vendor determines its own RSSI scale/values.

RSTP

Rapid Spanning Tree Protocol. RSTP provides significantly faster spanning tree convergence after a topology change, introducing new convergence behaviors and bridge port roles to do this.

RTCP

RTP Control Protocol. RTCP provides out-of-band statistics and control information for an Real-Time Transport Protocol session.

RTLS

Real-Time Location Systems. RTLS automatically identifies and tracks the location of objects or people in real time, usually within a building or other contained area.

RTP

Real-Time Transport Protocol. RTP is a network protocol used for delivering audio and video over IP networks.

RTS

Request to Send. RTS refers to the data transmission and protection mechanism used by the 802.11 wireless networking protocol to prevent frame collision occurrences. See CTS.

RTSP

Real Time Streaming Protocol. RTSP is a network control protocol designed for use in entertainment and communications systems to control streaming media servers.

RVI

Routed VLAN Interface. RVI is a switch interface that forwards packets between VLANs.

RW

Rest of World. RoW or RW is an operating country code of a device.

SA

Security Association. SA is the establishment of shared security attributes between two network entities to support secure communication.

SAML

Security Assertion Markup Language. SAML is an XML-based framework for communicating user authentication, entitlement, and attribute information. SAML enables single sign-on by allowing users to authenticate at an identity provider and then access service providers without additional authentication.

SCEP

Simple Certificate Enrollment Protocol. SCEP is a protocol for requesting and managing digital certificates.

SCP

Secure Copy Protocol. SCP is a network protocol that supports file transfers between hosts on a network.

SCSI

Small Computer System Interface. SCSI refers to a set of interface standards for physical connection and data transfer between a computer and the peripheral devices such as printers, disk drives, CD-ROM, and so on.

SD-WAN

Software-Defined Wide Area Network. SD-WAN is an application for applying SDN technology to WAN connections that connect enterprise networks across disparate geographical locations.

SDN

Software-Defined Networking. SDN is an umbrella term encompassing several kinds of network technology aimed at making the network as agile and flexible as the virtualized server and storage infrastructure of the modern data center.

SDR

Server Derivation Rule. An SDR refers to a role assignment model used by the controllers running ArubaOS to assign roles and VLANs to the WLAN users based on the rules defined under a server group. The SDRs override the default authentication roles and VLANs defined in the AAA and Virtual AP profiles.

SDU

Service Data Unit. SDU is a unit of data that has been passed down from an OSI layer to a lower layer and that has not yet been encapsulated into a PDU by the lower layer.

SFP

The Small Form-factor Pluggable. SFP is a compact, hot-pluggable transceiver that is used for both telecommunication and data communications applications.

SFP+

Small Form-factor Pluggable+. SFP+ supports up to data rates up to 16 Gbps.

SFTP

Secure File Transfer Protocol. SFTP is a network protocol that allows file access, file transfer, and file management functions over a secure connection.

SHA

Secure Hash Algorithm. SHA is a family of cryptographic hash functions. The SHA algorithm includes the SHA, SHA-1, SHA-2 and SHA-3 variants.

SIM

Subscriber Identity Module. SIM is an integrated circuit that is intended to securely store the International Mobile Subscriber Identity (IMSI) number and its related key, which are used for identifying and authenticating subscribers on mobile telephony devices.

SIP

Session Initiation Protocol. SIP is used for signaling and controlling multimedia communication session such as voice and video calls.

SIRT

Security Incident Response Team. SIRT is responsible for reviewing as well as responding to computer security incident reports and activity.

SKU

Stock Keeping Unit. SKU refers to the product and service identification code for the products in the inventory.

SLAAC

Stateless Address Autoconfiguration. SLAAC provides the ability to address a host based on a network prefix that is advertised from a local network router through router advertisements.

SMB

Server Message Block or Small and Medium Business. Server Message Block operates as an application-layer network protocol mainly used for providing shared access to files, printers, serial ports, and for miscellaneous communications between the nodes on a network.

SMS

Short Message Service. SMS refers to short text messages (up to 140 characters) sent and received through mobile phones.

SMTP

Simple Mail Transfer Protocol. SMTP is an Internet standard protocol for electronic mail transmission.

SNIR

Signal-to-Noise-Plus-Interference Ratio. SNIR refers to the power of a central signal of interest divided by the sum of the interference power and the power of the background noise. SINR is defined as the power of a certain signal of interest divided by the sum of the interference power (from all the other interfering signals) and the power of some background noise.

SNMP

Simple Network Management Protocol. SNMP is a TCP/IP standard protocol for managing devices on IP networks. Devices that typically support SNMP include routers, switches, servers, workstations, printers, modem racks, and more. It is used mostly in network management systems to monitor network-attached devices for conditions that warrant administrative attention.

SNMPv1

Simple Network Management Protocol version 1. SNMPv1 is a widely used network management protocol.

SNMPv2

Simple Network Management Protocol version 2. SNMPv2 is an enhanced version of SNMPv1, which includes improvements in the areas of performance, security, confidentiality, and manager-to-manager communications.

SNMPv2c

Community-Based Simple Network Management Protocol version 2. SNMPv2C uses the community-based security scheme of SNMPv1 and does not include the SNMPv2 security model.

SNMPv3

Simple Network Management Protocol version 3. SNMPv3 is an enhanced version of SNMP that includes security and remote configuration features.

SNR

Signal-to-Noise Ratio. SNR is used for comparing the level of a desired signal with the level of background noise.

SNTP

Simple Network Time Protocol. SNTP is a less complex implementation of NTP. It uses the same , but does not require the storage of state over extended periods of time.

SOAP

Simple Object Access Protocol. SOAP enables communication between the applications running on different operating systems, with different technologies and programming languages. SOAP is an XML-based messaging protocol for exchanging structured information between the systems that support web services.

SoC

System on a Chip. SoC is an Integrated Circuit that integrates all components of a computer or other electronic system into a single chip.

source NAT

Source NAT changes the source address of the packets passing through the router. Source NAT is typically used when an internal (private) host initiates a session to an external (public) host.

SSH

Secure Shell. SSH is a network protocol that provides secure access to a remote device.

SSID

Service Set Identifier. SSID is a name given to a WLAN and is used by the client to access a WLAN network.

SSL

Secure Sockets Layer. SSL is a computer networking protocol for securing connections between network application clients and servers over the Internet.

SSO

Single Sign-On. SSO is an access-control property that allows the users to log in once to access multiple related, but independent applications or systems to which they have privileges. The process authenticates the user across all allowed resources during their session, eliminating additional login prompts.

STBC

Space-Time Block Coding. STBC is a technique used in wireless communications to transmit multiple copies of a data stream across a number of antennas and to exploit the various received versions of the data to improve the reliability of data transfer.

STM

Station Management. STM is a process that handles AP management and user association.

STP

Spanning Tree Protocol. STP is a network protocol that builds a logical loop-free topology for Ethernet networks.

SU-MIMO

Single-User Multiple-Input Multiple-Output. SU-MIMO allocates the full bandwidth of the AP to a single high-speed device during the allotted time slice.

subnet

Subnet is the logical division of an IP network.

subscription

A business model where a customer pays a certain amount as subscription price to obtain access to a product or service.

SVP

SpectraLink Voice Priority. SVP is an open, straightforward QoS approach that has been adopted by most leading vendors of WLAN APs. SVP favors isochronous voice packets over asynchronous data packets when contending for the wireless medium and when transmitting packets onto the wired LAN.

SWAN

Structured Wireless-Aware Network. A technology that incorporates a Wireless Local Area Network (WLAN) into a wired Wide Area Network (WAN). SWAN technology can enable an existing wired network to serve hundreds of users, organizations, corporations, or agencies over a large geographic area. SWAN is said to be scalable, secure, and reliable.

TAC

Technical Assistance Center.

TACACS

Terminal Access Controller Access Control System. TACACS is a family of protocols that handles remote authentication and related services for network access control through a centralized server.

TACACS+

Terminal Access Controller Access Control System+. TACACS+ provides separate authentication, authorization, and accounting services. It is derived from, but not backward compatible with, TACACS.

TCP

Transmission Control Protocol. TCP is a communication protocol that defines the standards for establishing and maintaining network connection for applications to exchange data.

TCP/IP

Transmission Control Protocol/ Internet Protocol. TCP/IP is the basic communication language or protocol of the Internet.

TFTP

Trivial File Transfer Protocol. The TFTP is a software utility for transferring files from or to a remote host.

TIM

Traffic Indication Map. TIM is an information element that advertises if any associated stations have buffered unicast frames. APs periodically send the TIM within a beacon to identify the stations that are using power saving mode and the stations that have undelivered data buffered on the AP.

TKIP

Temporal Key Integrity Protocol. A part of the WPA encryption standard for wireless networks. TKIP is the next-generation Wired Equivalent Privacy (WEP) that provides per-packet key mixing to address the flaws encountered in the WEP standard.

TLS

Transport Layer Security. TLS is a cryptographic protocol that provides communication security over the Internet. TLS encrypts the segments of network connections above the Transport Layer by using asymmetric cryptography for key exchange, symmetric encryption for privacy, and message authentication codes for message integrity.

TLV

Type-length-value or Tag-Length-Value. TLV is an encoding format. It refers to the type of data being processed, the length of the value, and the value for the type of data being processed.

ToS

Type of Service. The ToS field is part of the IPv4 header, which specifies datagrams priority and requests a route for low-delay, high-throughput, or a highly reliable service.

TPC

Transmit Power Control. TPC is a part of the 802.11h amendment. It is used to regulate the power levels used by 802.11a radio cards.

TPM

Trusted Platform Module. TPM is an international standard for a secure cryptoprocessor, which is a dedicated microcontroller designed to secure hardware by integrating cryptographic keys into devices.

TSF

Timing Synchronization Function. TSF is a WLAN function that is used for synchronizing the timers for all the stations in a BSS.

TSPEC

Traffic Specification. TSPEC allows an 802.11e client or a QoS-capable wireless client to signal its traffic requirements to the AP.

TSV

Tab-Separated Values. TSV is a file format that allows the exchange of tabular data between applications that use different internal data formats.

TTL

Time to Live. TTL or hop limit is a mechanism that sets limits for data expiry in a computer or network.

TTY

TeleTypeWriter. TTY-enabled devices allow telephones to transmit text communications for people who are deaf or hard of hearing as well as transmit voice communication.

TXOP

Transmission Opportunity. TXOP is used in wireless networks supporting the IEEE 802.11e Quality of Service (QoS) standard. Used in both EDCA and HCF Controlled Channel Access modes of operation, TXOP is a bounded time interval in which stations supporting QoS are permitted to transfer a series of frames. TXOP is defined by a start time and a maximum duration.

U-APSD

Unscheduled Automatic Power Save Delivery. U-APSD is a part of 802.11e and helps considerably in increasing the battery life of VoWLAN terminals.

UAM

Universal Access Method. UAM allows subscribers to access a wireless network after they successfully log in from a web browser.

UCC

Unified Communications and Collaboration. UCC is a term used to describe the integration of various communications methods with collaboration tools such as virtual whiteboards, real-time audio and video conferencing, and enhanced call control capabilities.

UDID

Unique Device Identifier. UDID is used to identify an iOS device.

UDP

User Datagram Protocol. UDP is a part of the TCP/IP family of protocols used for data transfer. UDP is typically used for streaming media. UDP is a stateless protocol, which means it does not acknowledge that the packets being sent have been received.

UDR

User Derivation Rule. UDR is a role assignment model used by the controllers running ArubaOS to assign roles and VLANs to the WLAN users based on MAC address, BSSID, DHCP-Option, encryption type, SSID, and the location of a user. For example, for an SSID with captive portal in the initial role, a UDR can be configured for scanners to provide a role based on their MAC OUI.

UHF

Ultra high frequency. UHF refers to radio frequencies between the range of 300 MHz and 3 GHz. UHF is also known as the decimeter band as the wavelengths range from one meter to one decimeter.

UI

User Interface.

UMTS

Universal Mobile Telecommunication System. UMTS is a third generation mobile cellular system for networks. See 3G.

UPnP

Universal Plug and Play. UPnP is a set of networking protocols that permits networked devices, such as personal computers, printers, Internet gateways, Wi-Fi APs, and mobile devices to seamlessly discover each

other's presence on the network and establish functional network services for data sharing, communications, and entertainment.

URI

Uniform Resource Identifier. URI identifies the name and the location of a resource in a uniform format.

URL

Uniform Resource Locator. URL is a global address used for locating web resources on the Internet.

USB

Universal Serial Bus. USB is a connection standard that offers a common interface for communication between the external devices and a computer. USB is the most common port used in the client devices.

UTC

Coordinated Universal Time. UTC is the primary time standard by which the world regulates clocks and time.

UWB

Ultra-Wideband. UWB is a wireless technology for transmitting large amounts of digital data over a wide spectrum of frequency bands with very low power for a short distance.

VA

Virtual Appliance. VA is a pre-configured virtual machine image, ready to run on a hypervisor.

VBR

Virtual Beacon Report. VBR displays a report with the MAC address details and RSSI information of an AP.

VHT

Very High Throughput. IEEE 802.11 ac is an emerging VHT WLAN standard that could achieve physical data rates of close to 7 Gbps for the 5 GHz band.

VIA

Virtual Intranet Access. VIA provides secure remote network connectivity for Android, Apple iOS, Mac OS X, and Windows mobile devices and laptops. It automatically scans and selects the best secure connection to the corporate network.

VLAN

Virtual Local Area Network. In computer networking, a single Layer 2 network may be partitioned to create multiple distinct broadcast domains, which are mutually isolated so that packets can only pass between them through one or more routers; such a domain is referred to as a Virtual Local Area Network, Virtual LAN, or VLAN.

VM

Virtual Machine. A VM is an emulation of a computer system. VMs are based on computer architectures and provide functionality of a physical computer.

VoIP

Voice over IP. VoIP allows transmission of voice and multimedia content over an IP network.

VoWLAN

Voice over WLAN. VoWLAN is a method of routing telephone calls for mobile users over the Internet using the technology specified in IEEE 802.11b. Routing mobile calls over the Internet makes them free, or at least much less expensive than they would be otherwise.

VPN

Virtual Private Network. VPN enables secure access to a corporate network when located remotely. It enables a computer to send and receive data across shared or public networks as if it were directly connected to the private network, while benefiting from the functionality, security, and management policies of the private network. This is done by establishing a virtual point-to-point connection through the use of dedicated connections, encryption, or a combination of the two.

VRD

Validated Reference Design. VRDs are guides that capture the best practices for a particular technology in field.

VRF

VisualRF. VRF is an AirWave Management Platform (AMP) module that provides a real-time, network-wide views of your entire Radio Frequency environment along with floor plan editing capabilities. VRF also includes overlays on client health to help diagnose issues related to clients, floor plan, or a specific location.

VRF Plan

VisualRF Plan. A stand-alone Windows client used for basic planning procedures such as adding a floor plan, provisioning APs, and generating a Bill of Materials report.

VRRP

Virtual Router Redundancy Protocol. VRRP is an election protocol that dynamically assigns responsibility for a virtual router to one of the VRRP routers on a LAN.

VSA

Vendor-Specific Attribute. VSA is a method for communicating vendor-specific information between NASs and RADIUS servers.

VTP

VLAN Trunking Protocol. VTP is a Cisco proprietary protocol for propagating VLANs on a LAN.

W-CDMA

Wideband Code-Division Multiple Access. W-CDMA is a third-generation (3G) mobile wireless technology that promises much higher data speeds to mobile and portable wireless devices.

walled garden

Walled garden is a feature that allows blocking of unauthorized users from accessing network resources.

WAN

Wide Area Network. WAN is a telecommunications network or computer network that extends over a large geographical distance.

WASP

Wireless Application Service Provider. WASP provides a web-based access to applications and services that would otherwise have to be stored locally and makes it possible for customers to access the service from a variety of wireless devices, such as a smartphone or Personal Digital Assistant (PDA).

WAX

Wireless abstract XML. WAX is an abstract markup language and a set of tools that is designed to help wireless application development as well as portability. Its tags perform at a higher level of abstraction than that of other wireless markup languages such as HTML, HDML, WML, XSL, and more.

web service

Web services allow businesses to share and process data programmatically. Developers who want to provide integrated applications can use the API to programmatically perform actions that would otherwise require manual operation of the user interface.

WEP

Wired Equivalent Privacy. WEP is a security protocol that is specified in 802.11 b and is designed to provide a WLAN with a level of security and privacy comparable to what is usually expected of a wired LAN.

WFA

Wi-Fi Alliance. WFA is a non-profit organization that promotes Wi-Fi technology and certifies Wi-Fi products if they conform to certain standards of interoperability.

Wi-Fi

Wi-Fi is a technology that allows electronic devices to connect to a WLAN network, mainly using the 2.4 GHz and 5 GHz radio bands. Wi-Fi can apply to products that use any 802.11 standard.

WIDS

Wireless Intrusion Detection System. WIDS is an application that detects the attacks on a wireless network or wireless system.

WiMAX

Worldwide Interoperability for Microwave Access. WiMAX refers to the implementation of IEEE 802.16 family of wireless networks standards set by the WiMAX forum.

WIP

Wireless Intrusion Protection. The WIP module provides wired and wireless AP detection, classification, and containment. It detects Denial of Service (DoS) and impersonation attacks, and prevents client and network intrusions.

WIPS

Wireless Intrusion Prevention System. WIPS is a dedicated security device or integrated software application that monitors the radio spectrum of WLAN network for rogue APs and other wireless threats.

WISP

Wireless Internet Service Provider. WISP allows subscribers to connect to a server at designated hotspots using a wireless connection such as Wi-Fi. This type of ISP offers broadband service and allows subscriber computers called stations, to access the Internet and the web from anywhere within the zone of coverage provided by the server antenna, usually a region with a radius of several kilometers.

WISPr

Wireless Internet Service Provider Roaming. The WISPr framework enables the client devices to roam between the wireless hotspots using different ISPs.

WLAN

Wireless Local Area Network. WLAN is a 802.11 standards-based LAN that the users access through a wireless connection.

WME

Wireless Multimedia Extension. WME is a Wi-Fi Alliance interoperability certification, based on the IEEE 802.11 e standard. It provides basic QoS features to IEEE 802.11 networks. WMM prioritizes traffic according to four ACs: voice (AC_VO), video (AC_VI), best effort (AC_BE) and background (AC_BK). See WMM.

WMI

Windows Management Instrumentation. WMI consists of a set of extensions to the Windows Driver Model that provides an operating system interface through which instrumented components provide information and notification.

WMM

Wi-Fi Multimedia. WMM is also known as WME. It refers to a Wi-Fi Alliance interoperability certification, based on the IEEE 802.11 e standard. It provides basic QoS features to IEEE 802.11 networks. WMM prioritizes traffic according to four ACs: voice (AC_VO), video (AC_VI), best effort (AC_BE), and background (AC_BK).

WPA

Wi-Fi Protected Access. WPA is an interoperable wireless security specification subset of the IEEE 802.11 standard. This standard provides authentication capabilities and uses TKIP for data encryption.

WPA2

Wi-Fi Protected Access 2. WPA2 is a certification program maintained by IEEE that oversees standards for security over wireless networks. WPA2 supports IEEE 802.1X/EAP authentication or PSK technology, but includes advanced encryption mechanism using CCMP that is referred to as AES.

WSDL

Web Service Description Language. WSDL is an XML-based interface definition language used to describe the functionality provided by a web service.

WSP

Wireless Service Provider. The service provider company that offers transmission services to users of wireless devices through Radio Frequency (RF) signals rather than through end-to-end wire communication.

WWW

World Wide Web.

X.509

X.509 is a standard for a public key infrastructure for managing digital certificates and public-key encryption. It is an essential part of the Transport Layer Security protocol used to secure web and email communication.

XAuth

Extended Authentication. XAuth provides a mechanism for requesting individual authentication information from the user, and a local user database or an external authentication server. It provides a method for storing the authentication information centrally in the local network.

XML

Extensible Markup Language. XML is a markup language that defines a set of rules for encoding documents in a format that is both human-readable and machine-readable.

XML-RPC

XML Remote Procedure Call. XML-RPC is a protocol that uses XML to encode its calls and HTTP as a transport mechanism. Developers who want to provide integrated applications can use the API to programmatically perform actions that would otherwise require manual operation of the user interface.

ZTP

Zero Touch Provisioning. ZTP is a device provisioning mechanism that allows automatic and quick provisioning of devices with a minimal or at times no manual intervention.

